

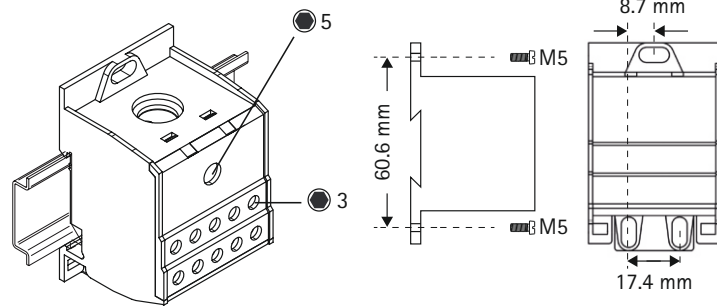



38674

I_n 175 A CU - IEC
135 A AL - IEC

175 A CU - UL
135 A AL - UL

U_i 1000 V AC / 1500 V DC - IEC
600 V AC/DC - UL



TORQUE				
4 Nm 35,5 lb.in	10 - 50 mm ² 8 - 1/0 AWG	10 - 70 mm ² 8 - 2/0 AWG	1 × Ø 12 mm	15 mm
2 Nm 18 lb.in	2,5 - 10 mm ² 14 - 6 AWG	2,5 - 16 mm ² 14 - 4 AWG	10 × Ø 6,5 mm	11 mm

Technical changes and errors as well as changes in appearance reserved.

BAV-00123-C | 19.06.2024