

# REPLACEMENT PARTS

---







# CHAPTER 9

## In This Chapter...

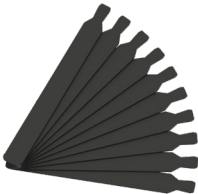
Replacement Parts Overview .....	9-2
Panel Mounting Clip Replacements – EA9-BRK.....	9-3
Logo Label Replacement Insert - EA9-LBL .....	9-4
3-wire Communications Terminal Block – EA9-3TB.....	9-5
DC Panel Power Connector Replacement – EA-DC-CON .....	9-5
AC Power Adapter Connector Replacement– EA-AC-CON.....	9-6
Panel Gasket Replacements – EA9-xx-GSK .....	9-7
Gasket Replacement Installation Instructions: .....	9-7

## Replacement Parts Overview

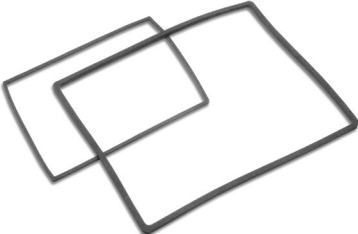
Part Number		Description
EA9-BRK		Panel mounting brackets, replacement, for <b>C-more</b> EA9 series touch panels. Package of 8 brackets and screws.
EA9-LBL		Blank label insert for front bezel, replacement, for <b>C-more</b> EA9 series touch panels. Package of 10.
EA9-3TB		3-pole terminal block, replacement, for 3-wire RS485 communications port on <b>C-more</b> EA9 series panels. Package of 2.
EA-DC-CON		5-terminal DC power connector, replacement, for <b>C-more</b> EA7 and EA9 series touch panels
EA-AC-CON		3-terminal AC power connector, replacement, for <b>C-more</b> EA7 and EA9 series touch panels
EA9-15-GSK		Panel mounting gasket, replacement, for <b>C-more</b> EA9-T15CL 15-inch touch panel, NEMA 4/4X
EA9-12-GSK		Panel mounting gasket, replacement, for <b>C-more</b> EA9-T12CL 12-inch touch panel, NEMA 4/4X
EA9-10-GSK		Panel mounting gasket, replacement, for <b>C-more</b> EA9-T10CL 10-inch touch panel, NEMA 4/4X
EA9-10W-GSK		Panel mounting gasket, replacement, for <b>C-more</b> EA9-T10WCL 10-inch touch panel, NEMA 4/4X
EA9-8-GSK		Panel mounting gasket, replacement, for <b>C-more</b> EA9-T8CL 8-inch touch panel, NEMA 4/4X
EA9-6-GSK		Panel mounting gasket, replacement, for <b>C-more</b> EA9-T6CL(-R) 6-inch and EA9-T7CL(-R) 7-inch touch panels, NEMA 4/4X

## Panel Mounting Clip Replacements – EA9-BRK



Spare panel mounting clips for EA9 series *C-more* touch panels.  
Package of 8 clips with 8 screws.

### Mounting Clip Instructions

1. Position the touch panel through the cutout in the control cabinet door and hold in place. Position the mounting clips as appropriate for your model. Refer to Chapter 2.
2. Tighten the mounting screws in an alternating fashion while observing the front of the touch panel. The goal is to make sure the front bezel is pulled up against the enclosure sheet metal uniformly, and the touch panel gasket is fully compressed all the way around its perimeter. Tighten the screws to a torque rating shown in the table below. Avoid over-tightening the screws to the point that they start to deform or bend the bezel or mounting clip.

Touch Panel Size	Enclosure Thickness Range	Mounting Clip Screw Torque	Material
6", 7", 8", 10" & 12"	0.039 - 0.20 inch [1 - 5 mm]	63 - 77 oz-in [0.45 - 0.55 Nm]	Metal
10" Wide, 15"	0.039 - 0.20 inch [1 - 5 mm]]	92 - 106 oz-in [0.65 - 0.75 Nm]	

## Logo Label Replacement Insert - EA9-LBL

*C-more* EA9 series panels include one customizable logo label. Additional logo labels can be purchased in packs of 10.

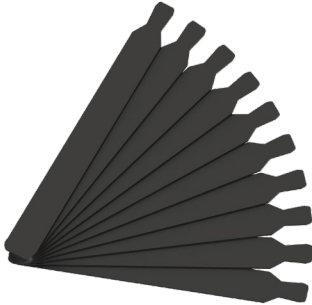

**Removal-** Insert small tool such as a jewelers screwdriver and pull tab away from housing.



**Installation -** Insert EA9-LBL into the slot in the side of the panel and lock tab into place.



9

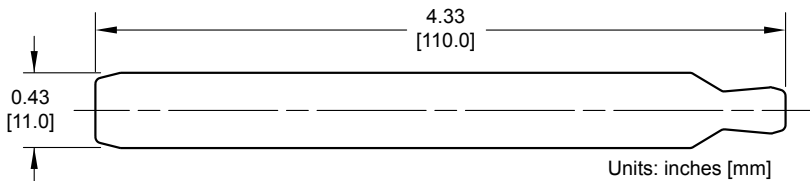

## 3-wire Communications Terminal Block – EA9-3TB

*C-more* EA9 series 3-wire communications terminal block replacement. One (1) terminal block is supplied with each touch panel.



Tightening Torque	
Cable torque	minimum 1.95 lb-in (0.22 Nm)



**NOTE:** Use 60 / 75 °C copper conductors only, 24 - 12 AWG

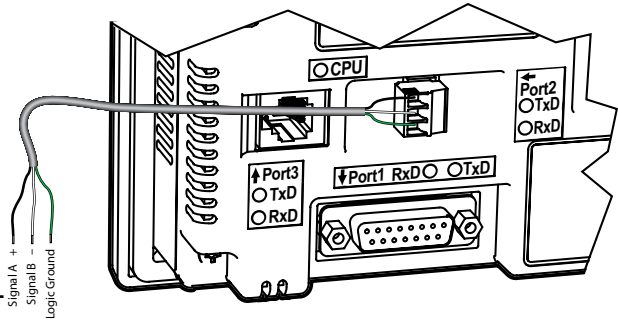

## DC Panel Power Connector Replacement – EA-DC-CON

*C-more* touch panel 5-position DC power connector terminal block replacement. One (1) DC Power Connector is supplied with each touch panel.



DC-CON Tightening Torque	
Power connector screw torque	70.4 oz-in (0.5 Nm)
Power connector mounting torque	56 oz-in (0.4 Nm)



**NOTE:** Use 60 / 75 °C copper conductors only, 24 - 12 AWG

Recommended DC Supply Fuse		
Panel Size	Rating	ADC p/n
6" – 10"	2.5 A	MDL2-5
12" & 15"	4.0 A	MDL4

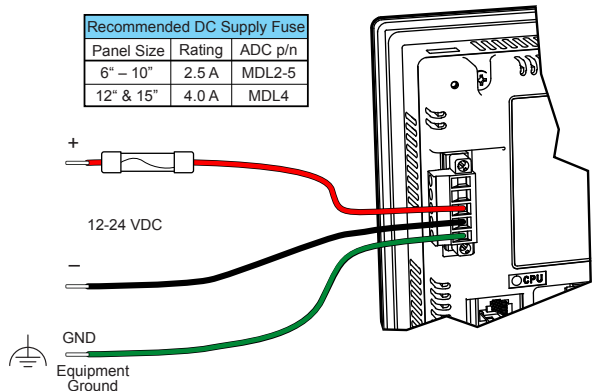

# AC Power Adapter Connector Replacement- EA-AC-CON

*C-more* AC power adapter 3-position AC power connector terminal block replacement. One (1) AC Power Connector is supplied with each AC/DC Power Adapter, EA-AC.



EA-AC Tightening Torque	
Power supply cable torque	71 - 85 oz-in (0.5 - 0.6 Nm)
Power connector mounting torque	71 - 85 oz-in (0.5 - 0.6 Nm)
Mounting flange screw torque	57 - 71 oz-in (0.4 - 0.5 Nm)



**NOTE:** Use 60 / 75 °C copper conductors only, 24 - 12 AWG

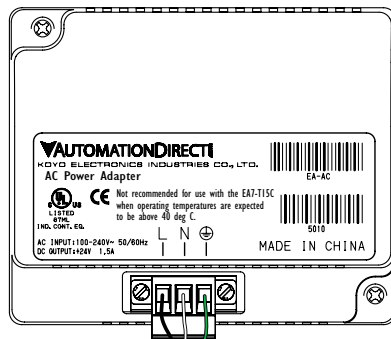

Recommended AC Supply Fuse  
3.0 A time delay, ADC p/n MDL3

100 - 240 VAC  
50/60 Hz

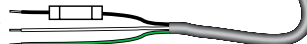

## Panel Gasket Replacements – EA9-xx-GSK

Replacement NEMA 4/4X touch panel gaskets for *C-more* 6", 7", 8", 10", 12" and 15" touch panels.

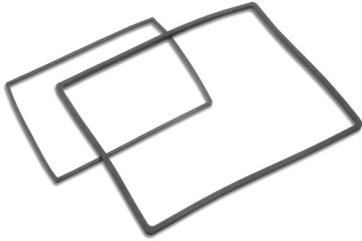

### Gasket Replacement Installation Instructions:

Preparation: Disconnect input power and all other connections, then remove the touch panel from the control cabinet. In a clean environment, place the panel face down on a lint-free soft surface to prevent scratching the front of the panel.



1 Start at one corner and pull the old gasket out of the channel that holds the gasket in place. Pull the gasket up as you work around the entire perimeter of the touch panel. Discard the old gasket.



2 Lay the new gasket over the channel so that the long and short sides of the gasket match up to the long and short sides of the touch panel. Start at one corner and match the gasket's corner to the channel's corner. Press the gasket into the channel and work all away around the perimeter of the touch panel. Re-install the touch panel.

