

INSTALLATION, WIRING AND SPECIFICATIONS



CHAPTER 2

In This Chapter...

Safety Guidelines	2-2
Mounting Guidelines	2-5
Installing DL205 Bases.....	2-10
Installing Components in the Base	2-12
Base Wiring Guidelines	2-13
I/O Wiring Strategies	2-14
I/O Module Positioning, Wiring, and Specification	2-26
DL205 I/O Module Specifications.....	2-30
F2-08TA, AC Output.....	2-44
Glossary of Specification Terms	2-52

NOTE: As of 07/2021 CPU D2-260 has been retired. Please consider CPU D2-262 as a replacement.

Safety Guidelines



NOTE: Products with CE marks perform their required functions safely and adhere to relevant standards as specified by CE directives, provided they are used according to their intended purpose and that the instructions in this manual are adhered to. The protection provided by the equipment may be impaired if this equipment is used in a manner not specified in this manual. A listing of our international affiliates is available on our Web site: <http://www.automationdirect.com>



WARNING: PROVIDING A SAFE OPERATING ENVIRONMENT FOR PERSONNEL AND EQUIPMENT IS YOUR RESPONSIBILITY AND SHOULD BE YOUR PRIMARY GOAL DURING SYSTEM PLANNING AND INSTALLATION. AUTOMATION SYSTEMS CAN FAIL AND MAY RESULT IN SITUATIONS THAT CAN CAUSE SERIOUS INJURY TO PERSONNEL AND/OR DAMAGE EQUIPMENT. DO NOT RELY ON THE AUTOMATION SYSTEM ALONE TO PROVIDE A SAFE OPERATING ENVIRONMENT. SUFFICIENT EMERGENCY CIRCUITS SHOULD BE PROVIDED TO STOP EITHER PARTIALLY OR TOTALLY THE OPERATION OF THE PLC OR THE CONTROLLED MACHINE OR PROCESS. THESE CIRCUITS SHOULD BE ROUTED OUTSIDE THE PLC IN THE EVENT OF CONTROLLER FAILURE, SO THAT INDEPENDENT AND RAPID SHUTDOWN IS AVAILABLE. DEVICES, SUCH AS "MUSHROOM" SWITCHES OR END OF TRAVEL LIMIT SWITCHES, SHOULD OPERATE MOTOR STARTER, SOLENOIDS, OR OTHER DEVICES WITHOUT BEING PROCESSED BY THE PLC. THESE EMERGENCY CIRCUITS SHOULD BE DESIGNED USING SIMPLE LOGIC WITH A MINIMUM NUMBER OF HIGHLY RELIABLE ELECTROMECHANICAL COMPONENTS. EVERY AUTOMATION APPLICATION IS DIFFERENT, SO THERE MAY BE SPECIAL REQUIREMENTS FOR YOUR PARTICULAR APPLICATION. MAKE SURE TO FOLLOW ALL NATIONAL, STATE, AND LOCAL GOVERNMENT REQUIREMENTS FOR THE PROPER INSTALLATION AND USE OF YOUR EQUIPMENT.

Plan for Safety

The best way to provide a safe operating environment is to make personnel and equipment safety part of the planning process. You should examine every aspect of the system to determine which areas are critical to operator or machine safety.

If you are not familiar with PLC system installation practices, or your company does not have established installation guidelines, you should obtain additional information from the following sources.

- NEMA — The National Electrical Manufacturers Association, located in Washington, D.C., publishes many different documents that discuss standards for industrial control systems. You can order these publications directly from NEMA. Some of these include:
 - ICS 1, General Standards for Industrial Control and Systems
 - ICS 3, Industrial Systems
 - ICS 6, Enclosures for Industrial Control Systems
- NEC — The National Electrical Code provides regulations concerning the installation and use of various types of electrical equipment. Copies of the NEC Handbook can often be obtained from your local electrical equipment distributor or your local library.
- Local and State Agencies — many local and state governments have additional requirements above and beyond those described in the NEC Handbook. Check with your local Electrical Inspector or Fire Marshall office for information.

Three Levels of Protection

The publications mentioned provide many ideas and requirements for system safety. At a minimum, you should follow these regulations. Also, you should use the following techniques, which provide three levels of system control.

- Emergency stop switch for disconnecting system power
- Mechanical disconnect for output module power
- Orderly system shutdown sequence in the PLC control program

Emergency Stops

It is recommended that emergency stop circuits be incorporated into the system for every machine controlled by a PLC. For maximum safety in a PLC system, these circuits must not be wired into the controller, but should be hardwired external to the PLC. The emergency stop switches should be easily accessed by the operator and are generally wired into a master control relay (MCR) or a safety control relay (SCR) that will remove power from the PLC I/O system in an emergency.

MCRs and SCRs provide a convenient means for removing power from the I/O system during an emergency situation. By de-energizing an MCR (or SCR) coil, power to the input (optional) and output devices is removed. This event occurs when any emergency stop switch opens. However, the PLC continues to receive power and operate even though all its inputs and outputs are disabled.

The MCR circuit could be extended by placing a PLC fault relay (closed during normal PLC operation) in series with any other emergency stop conditions. This would cause the MCR circuit to drop the PLC I/O power in case of a PLC failure (memory error, I/O communications error, etc).

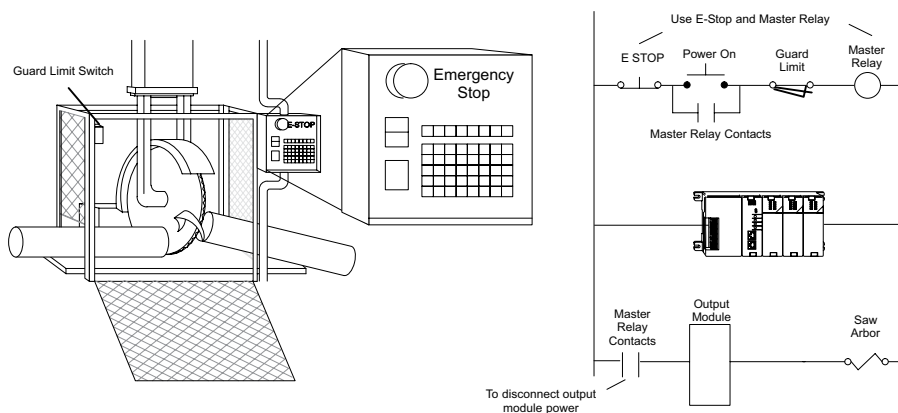

Emergency Power Disconnect

A properly rated emergency power disconnect should be used to power the PLC-controlled system as a means of removing the power from the entire control system. It may be necessary to install a capacitor across the disconnect to protect against a condition known as “outrush.” This condition occurs when the output Triacs are turned off by powering off the disconnect, thus causing the energy stored in the inductive loads to seek the shortest distance to ground, which is often through the Triacs.

After an emergency shutdown or any other type of power interruption, there may be requirements that must be met before the PLC control program can be restarted. For example, there may be specific register values that must be established (or maintained from the state prior to the shutdown) before operations can resume. In this case, you may want to use retentive memory locations, or include constants in the control program to ensure a known starting point.

Orderly System Shutdown

Ideally, the first level of fault detection is the PLC control program, which can identify machine problems. Certain shutdown sequences should be performed. The types of problems are usually things such as jammed parts, etc., that not pose a risk of personal injury or equipment damage.

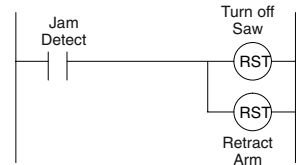
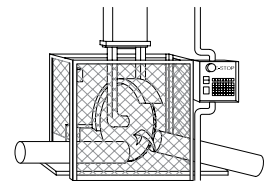

WARNING: The control program must not be the only form of protection for any problems that may result in a risk of personal injury or equipment damage.

Class 1, Division 2, Approval

This equipment is suitable for use in Class 1, Zone 2, Division groups A, B, C and D or non-hazardous locations only.

WARNING: Explosion Hazard! Substitution of components may impair suitability for Class 1, Division 2. Do not disconnect equipment unless power has been switched off or area is known to be non-hazardous.

WARNING: Explosion Hazard! Do not disconnect equipment unless power has been switched off or the area is known to be non-hazardous.



WARNING: All models used with connector accessories must use R/C (ECBT2) mating plug for all applicable models. All mating plugs shall have suitable ratings for device.

WARNING: This equipment is designed for use in Pollution Degree 2 environments (installed within an enclosure rated at least IP54).

WARNING: Transient suppression must be provided to prevent the rated voltage from being exceeded by 140%.

Mounting Guidelines

Before installing the PLC system, you will need to know the dimensions of the components considered. The diagrams on the following pages provide the component dimensions to use in defining your enclosure specifications. Remember to leave room for potential expansion.



NOTE: If you are using other components in your system, refer to the appropriate manual to determine how those units can affect mounting dimensions.

Base Dimensions

The following information shows the proper mounting dimensions. The height dimension is the same for all bases. The depth varies depending on your choice of I/O module. The length varies as the number of slots increase. Make sure you have followed the installation guidelines for proper spacing.

Mounting depths with:

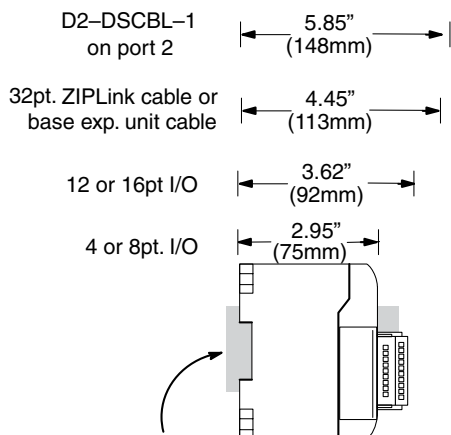

DIN Rail slot. Use rail conforming to DIN EN 50022.

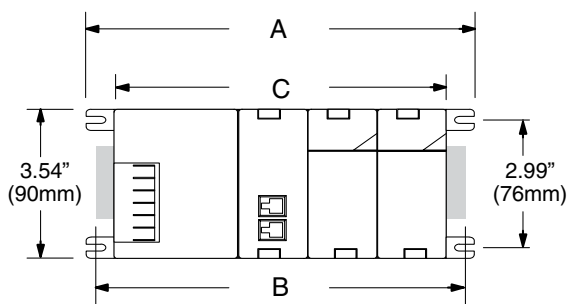

with D2-EM Expansion Unit

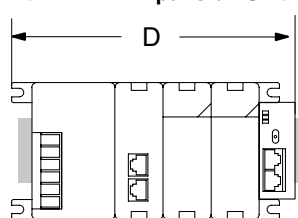

Base	A (Base Total Width)		B (Mounting Hole)		C (Component Width)		D (Width w/ Exp. Unit)	
	Inches	Millimeters	Inches	Millimeters	Inches	Millimeters	Inches	Millimeters
3-slot	6.77	172	6.41	163	5.8	148	7.24	184
4-slot	7.99	203	7.63	194	7.04	179	8.46	215
6-slot	10.43	265	10.07	256	9.48	241	10.90	277
9-slot	14.09	358	13.74	349	13.14	334	14.56	370

Panel Mounting and Layout

It is important to design your panel properly to help ensure the DL205 products operate within their environmental and electrical limits. The system installation should comply with all appropriate electrical codes and standards. It is important the system also conforms to the operating standards for the application to ensure proper performance. The diagrams below reference the items in the following list.

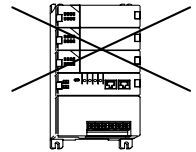
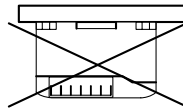
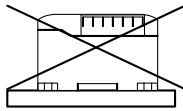
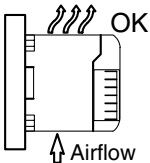

1. Mount the bases horizontally to provide proper ventilation.
2. If you place more than one base in a cabinet, there should be a minimum of 7.2" (183mm) between bases.
3. Provide a minimum clearance of 2" (50mm) between the base and all sides of the cabinet. There should also be at least 1.2" (30mm) of clearance between the base and any wiring ducts.
4. There must be a minimum of 2" (50mm) clearance between the panel door and the nearest DL205 component.



NOTE: The cabinet configuration below is not suitable for EU installations. Refer to Appendix I, European Union Directives.

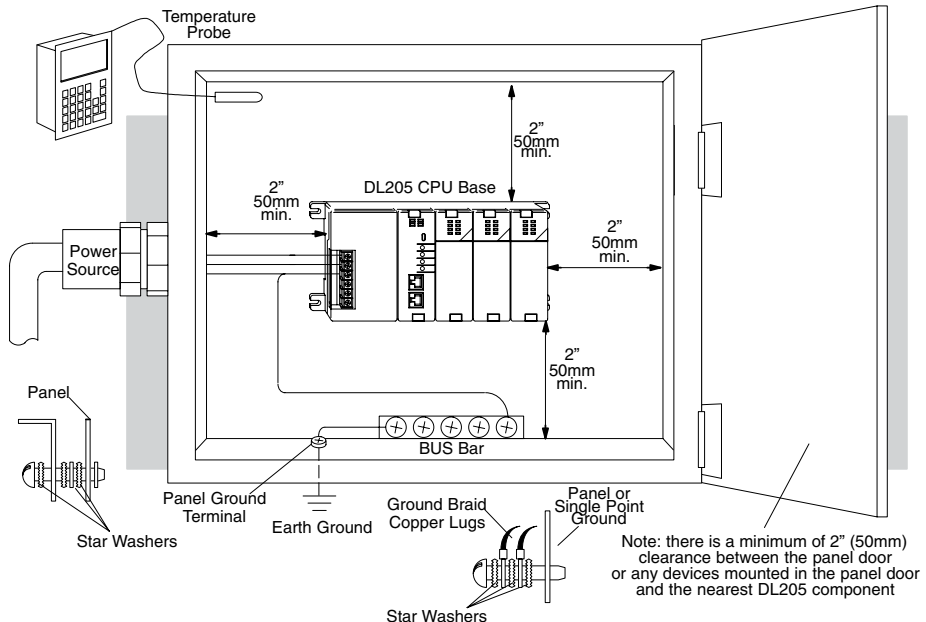

5. The ground terminal on the DL205 base must be connected to a single point ground. Use copper stranded wire to achieve a low impedance. Copper eye lugs should be crimped and soldered to the ends of the stranded wire to ensure good surface contact. Remove anodized finishes and use copper lugs and star washers at termination points. A general rule is to achieve a 0.1 ohm of DC resistance between the DL205 base and the single point ground.
6. There must be a single point ground (i.e., copper bus bar) for all devices in the panel requiring an earth ground return. The single point of ground must be connected to the panel ground termination. The panel ground termination must be connected to earth ground. For this connection you should use #12 AWG stranded copper wire at a minimum. Minimum wire sizes, color coding, and general safety practices should comply with appropriate electrical codes and standards for your region. A good common ground reference (Earth ground) is essential for proper operation of the DL205. Methods of providing an adequate common ground reference include:
 - Installing a ground rod as close to the panel as possible.
 - Connection to incoming power system ground.
7. Properly evaluate any installations where the ambient temperature may approach the lower or upper limits of the specifications. Place a temperature probe in the panel, close the door and operate the system until the ambient temperature has stabilized. If the ambient temperature is not within the operating specification for the DL205 system, measures such as installing a cooling/heating source must be taken to get the ambient temperature within the DL205 operating specifications.
8. Device mounting bolts and ground braid termination bolts should be #10 copper bolts or equivalent. Tapped holes instead of nut-bolt arrangements should be used whenever possible. To ensure good contact on termination areas, impediments such as paint, coating or corrosion should be removed in the area of contact.
9. The DL205 system is designed to be powered by 110/220 VAC, 24VDC, or 125VDC normally available throughout an industrial environment. Electrical power in some areas where the PLCs are installed is not always stable and storms can cause power surges. Due to this, powerline filters are recommended for protecting the DL205 PLCs from power surges and EMI/RFI noise. The Automation Powerline Filter, for use with 120VAC and 240VAC, 1–5 Amps, is an excellent choice (can be located at www.automationdirect.com); however, you can use a filter of your choice. These units install easily between the power source and the PLC.

Enclosures

Your selection of a proper enclosure is important to ensure safe and proper operation of your DL205 system. Applications of DL205 systems vary and may require additional features. The minimum considerations for enclosures include:

- Conformance to electrical standards
- Protection from the elements in an industrial environment
- Common ground reference
- Maintenance of specified ambient temperature
- Access to equipment
- Security or restricted access
- Sufficient space for proper installation and maintenance of equipment

Environmental Specifications

The following table lists the environmental specifications that generally apply to the DL205 system (CPU, Bases, I/O Modules). The ranges that vary for the Handheld Programmer are noted at the bottom of this chart. I/O module operation may fluctuate depending on the ambient temperature and your application. Refer to the appropriate I/O module specifications for the temperature derating curves applying to specific modules.

Specification	Rating
Storage Temperature	-4°F to 158°F (-20°C to 70°C)
Ambient Operating Temperature*	32°F to 131°F (0°C to 55°C)
Ambient Humidity**	30% – 95% relative humidity (non-condensing)
Vibration Resistance	MIL STD 810C, Method 514.2
Shock Resistance	MIL STD 810C, Method 516.2
Noise Immunity	NEMA (ICS3-304)
Atmosphere	No corrosive gases

* Operating temperature for the Handheld Programmer and the DV-1000 is 32° to 122°F (0° to 50°C) Storage temperature for the Handheld Programmer and the DV-1000 is - 4° to 158° F (- 20° to 70°C).

** Equipment will operate below 30% humidity. However, static electricity problems occur much more frequently at lower humidity levels. Make sure you take adequate precautions when you touch the equipment. Consider using ground straps, anti-static floor coverings, etc., if you use the equipment in low humidity environments.

Power

The power source must be capable of supplying voltage and current complying with the base power supply specifications.

Specification	AC Powered Bases	24VDC Powered Bases	125VDC Powered Bases
Part Numbers	D2-03B-1, D2-04B-1, D2-06B-1 D2-09B-1	D2-03BDC1-1, D2-04BDC1-1, D2-06BDC1-1, D2-09BDC1-1	D2-06BDC2-1, D2-09BDC2-1
Input Voltage Range	100-240 VAC (+10%/ -15%) 50/60Hz	10.2 – 28.8 VDC (24VDC) with less than 10% ripple	104-240 VDC +10% -15%
Maximum Inrush Current	30A	10A	20A
Maximum Power	80VA	25W	30W
Voltage Withstand (dielectric)	1 minute @ 1500VAC between primary, secondary, and field ground		
Insulation Resistance	> 10 MΩ at 500VDC		
Auxiliary 24 VDC Output	20-28 VDC, less than 1V p-p 300mA max.	None	20-28 VDC, less than 1V p-p 300mA max.
Fusing (internal to base power supply)	Non-replaceable 2A @ 250V slow blow fuse	Non-replaceable 3.15 A @ 250V slow blow fuse	Non-replaceable 2A @ 250V slow blow fuse

Agency Approvals

Some applications require agency approvals. The DL205 are submitted to the following agency approvals:

- UL (Underwriters Laboratories, LLC)
- CE EMC (Electromagnetic Compatibility)
- cUL (Canadian Underwriters' Laboratories)

24VDC Power Bases

Follow these additional installation guidelines when installing D2-03BDC1-1, D2-04BDC1-1, D2-06BDC1-1 and D2-09BDC1-1 bases:

- Install these bases in compliance with the enclosure, mounting, spacing, and segregation requirements of the ultimate application.
- These bases must be used within their marked ratings.
- These bases are intended to be installed within an enclosure rated at least IP54.
- Provisions should be made to prevent the rated voltage being exceeded by transient disturbances of more than 40%.

Installing DL205 Bases

Choosing the Base Type

The DL205 system offers four different sizes of bases and three different power supply options.

The following diagram shows an example of a 6-slot base.

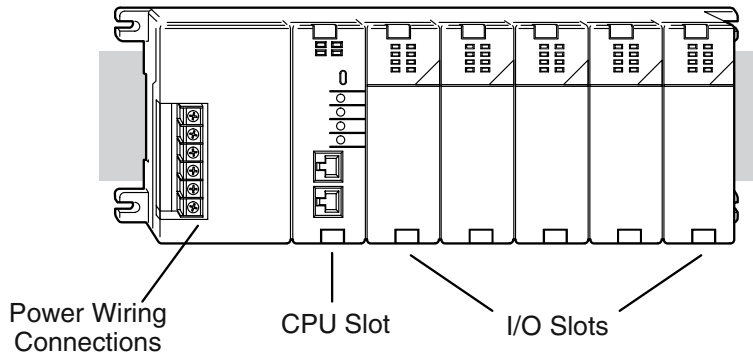

Your choice of base depends on three things:

- Number of I/O modules required
- Input power requirement (AC or DC power)
- Available power budget

Mounting the Base

All I/O configurations of the DL205 may use any of the base configurations. The bases are secured to the equipment panel or mounting location using four M4 screws in the corner tabs of the base. The full mounting dimensions are given in the previous section on Mounting Guidelines.

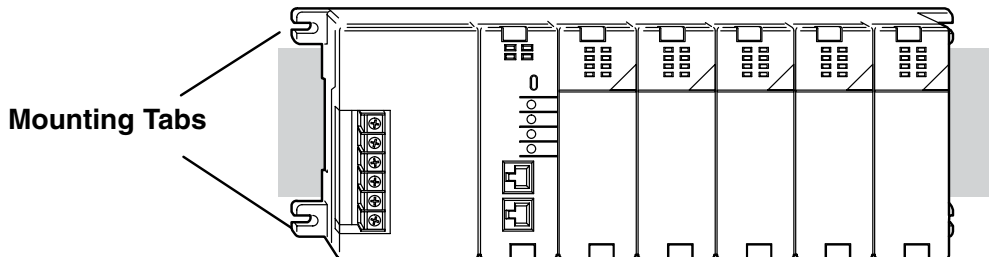

WARNING: To minimize the risk of electrical shock, personal injury, or equipment damage, always disconnect the system power before installing or removing any system component.

Using Mounting Rails

The DL205 bases can also be secured to the cabinet using mounting rails. You should use rails that conform to DIN EN standard 50 022. Refer to our catalog for a complete line of DIN-rail, DINnectors and DIN-rail mounted apparatus. These rails are approximately 35mm high, with a depth of 7.5 mm. If you mount the base on a rail, you should also consider using end brackets on each end of the rail. The end brackets help keep the base from sliding horizontally along the rail. This helps minimize the possibility of accidentally pulling the wiring loose.

If you examine the bottom of the base, you'll notice small retaining clips. To secure the base to a DIN-rail, place the base onto the rail and gently push up on the retaining clips. The clips lock the base onto the rail.

To remove the base, pull down on the retaining clips, lift up on the base slightly, and pull it away from the rail.

DIN Rail Dimensions

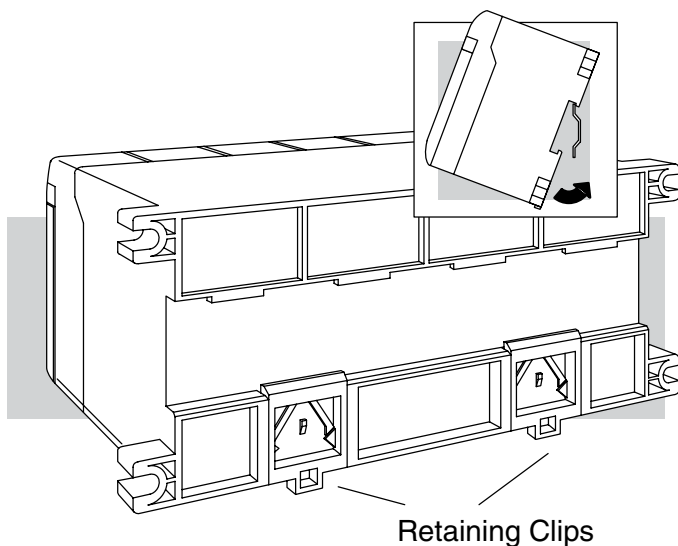
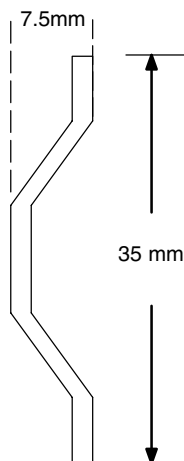

Installing Components in the Base

To insert components into the base: first slide the module retaining clips to the out position and align the PC board(s) of the module with the grooves on the top and bottom of the base. Push the module straight into the base until it is firmly seated in the backplane connector. Once the module is inserted into the base, push in the retaining clips to firmly secure the module to the base.

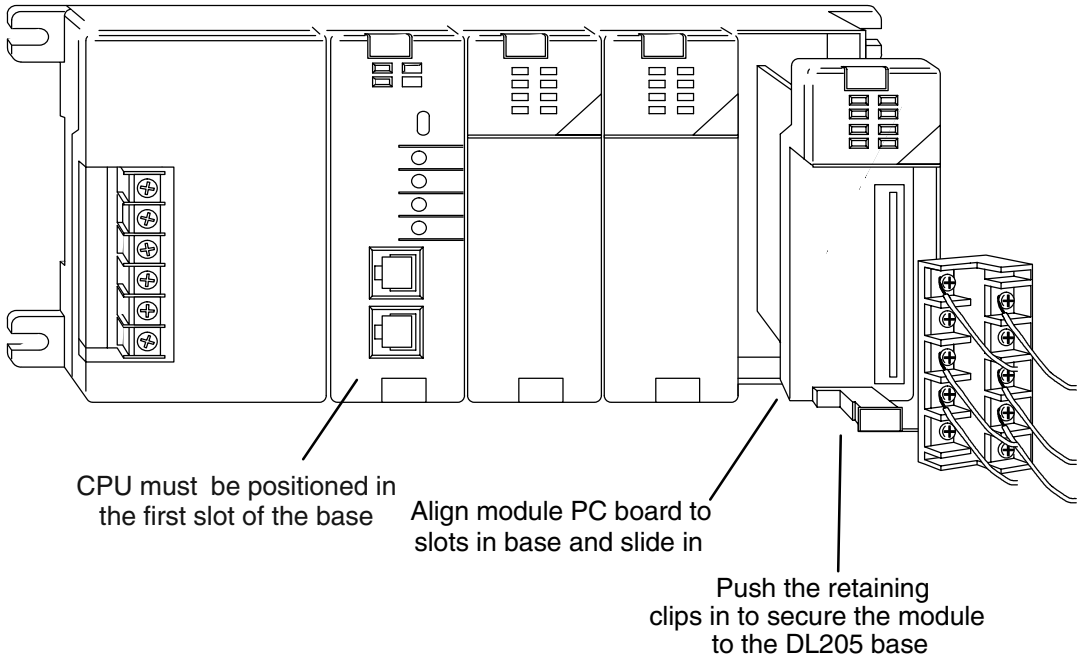

WARNING: Minimize the risk of electrical shock, personal injury, or equipment damage. Always disconnect the system power before installing or removing any system component.

Base Wiring Guidelines

Base Wiring

The diagrams show the terminal connections located on the power supply of the DL205 bases. The base terminals can accept up to 16 AWG. You may be able to use larger wiring depending on the type of wire used, but 16 AWG is the recommended size. Do not overtighten the connector screws; the recommended torque value is 7.81 lb-in (0.882 N-m).



NOTE: You can connect either a 115VAC or 220VAC supply to the AC terminals. Special wiring or jumpers are not required as with some of the other DirectLOGIC products.



WARNING: Once the power wiring is connected, install the plastic protective cover. When the cover is removed there is a risk of electrical shock if you accidentally touch the wiring or wiring terminals.

110/220 VAC Base Terminal Strip

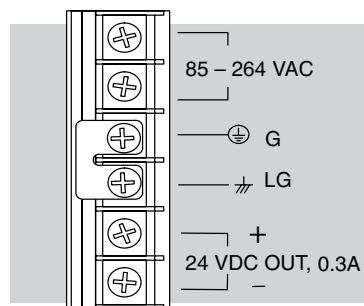

12/24 VDC Base Terminal Strip

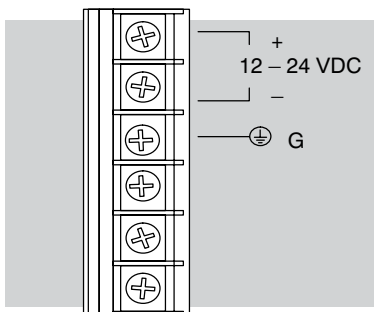

125 VDC Base Terminal Strip

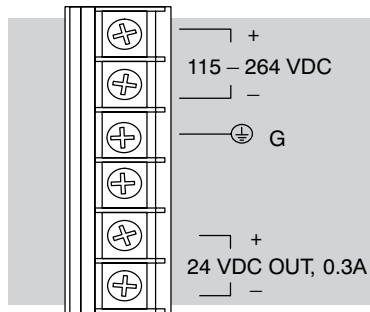

I/O Wiring Strategies

The DL205 PLC system is very flexible and will work in many different wiring configurations. By studying this section before actual installation, you can probably find the best wiring strategy for your application. This will help to lower system cost, wiring errors, and avoid safety problems.

PLC Isolation Boundaries

PLC circuitry is divided into three main regions separated by isolation boundaries, shown in the drawing below. Electrical isolation provides safety, so that a fault in one area does not damage another. A powerline filter will provide isolation between the power source and the power supply. A transformer in the power supply provides magnetic isolation between the primary and secondary sides. Opto-couplers provide optical isolation in Input and Output modules. This isolates logic circuitry from the field side, where factory machinery connects. Note the discrete inputs are isolated from the discrete outputs, because each is isolated from the logic side. Isolation boundaries protect the operator interface (and the operator) from power input faults or field wiring faults. When wiring a PLC, it is extremely important to avoid making external connections that connect logic side circuits to any other.

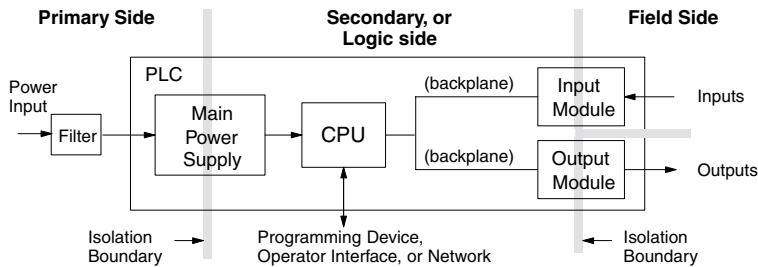

In addition to the basic circuits covered above, AC-powered and 125VDC bases include an auxiliary +24VDC power supply with its own isolation boundary. Since the supply output is isolated from the other three circuits, it can power input and/or output circuits!

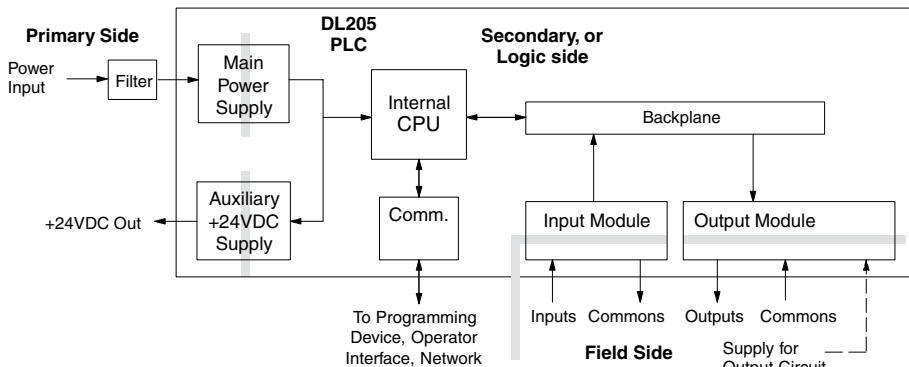

Powering I/O Circuits with the Auxiliary Supply

In some cases, using the built-in auxiliary +24VDC supply can result in a cost savings for your control system. It can power combined loads up to 300mA. Be careful not to exceed the current rating of the supply. If you are the system designer for your application, you may be able to select and design in field devices which can use the +24VDC auxiliary supply.

All AC powered and 125VDC DL205 bases feature the internal auxiliary supply. If input devices AND output loads need +24VDC power, the auxiliary supply may be able to power both circuits as shown in the following diagram.

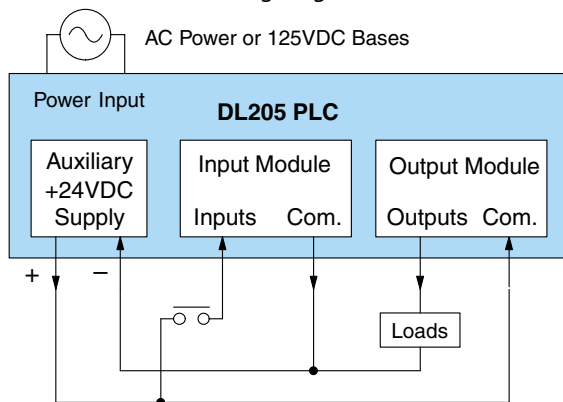

The 12/24 VDC-powered DL205 bases are designed for application environments in which low-voltage DC power is more readily available than AC. These include a wide range of battery-powered applications, such as remotely-located control, in vehicles, portable machines, etc. For this application type, all input devices and output loads typically use the same DC power source. Typical wiring for DC-powered applications is shown in the following diagram.

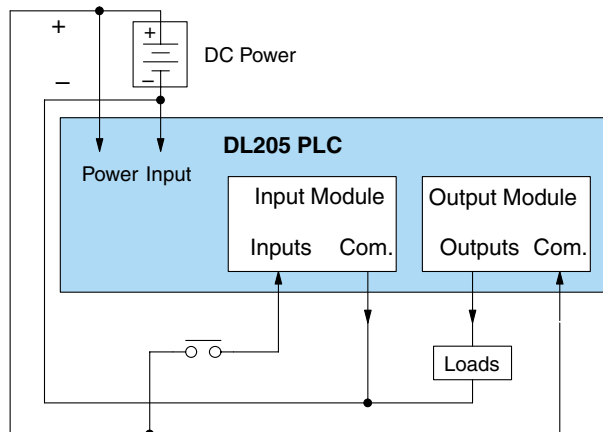

Powering I/O Circuits Using Separate Supplies

In most applications it will be necessary to power the input devices from one power source, and to power output loads from another source. Loads often require high-energy AC power, while input sensors use low-energy DC. If a machine operator is likely to come in close contact with input wiring, then safety reasons also require isolation from high-energy output circuits. It is most convenient if the loads can use the same power source as the PLC, and the input sensors can use the auxiliary supply, as shown to the left in the figure below.

If the loads cannot be powered from the PLC supply, then a separate supply must be used as shown to the right in the figure below.

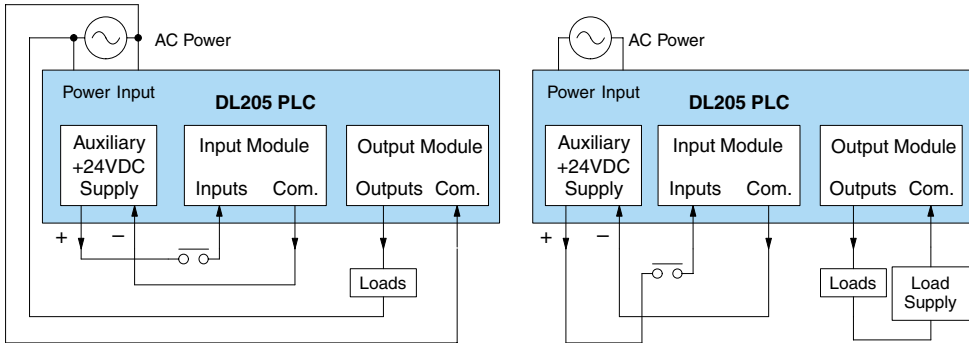

Some applications will use the PLC external power source to also power the input circuit. This typically occurs on DC-powered PLCs, as shown in the drawing below to the left. The inputs share the PLC power source supply, while the outputs have their own separate supply. A worst-case scenario, from a cost and complexity viewpoint, is an application which requires separate power sources for the PLC, input devices, and output loads. The example wiring diagram below on the right shows how this can work, but also the auxiliary supply output is an unused resource. You will want to avoid this situation if possible.

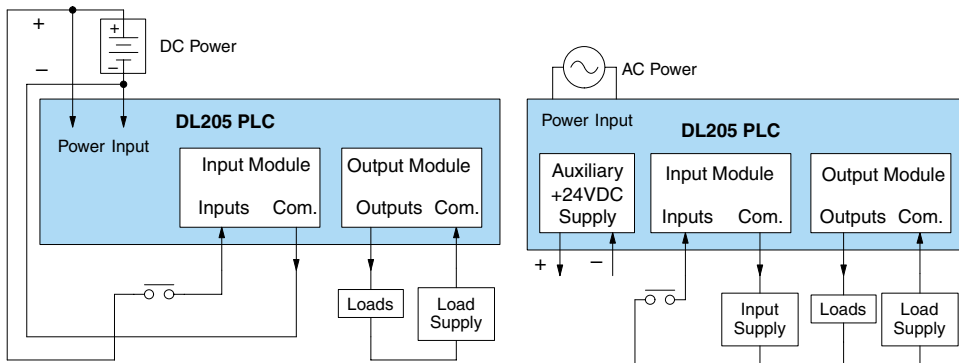

Sinking / Sourcing Concepts

Before going further in the study of wiring strategies, you must have a solid understanding of “sinking” and “sourcing” concepts. Use of these terms occurs frequently in input or output circuit discussions. It is the goal of this section to make these concepts easy to understand, further ensuring your success in installation. First the following short definitions are provided, followed by practical applications.

Sinking = provides a path to supply ground (-)

Sourcing = provides a path to supply source (+)

First you will notice these are only associated with DC circuits and not AC, because of the reference to (+) and (-) polarities. Therefore, sinking and sourcing terminology only applies to DC input and output circuits. Input and output points that are sinking only or sourcing only can conduct current in only one direction. This means it is possible to connect the external supply and field device to the I/O point with current trying to flow in the wrong direction, and the circuit will not operate. However, you can successfully connect the supply and field device every time by understanding “sourcing” and “sinking”.

For example, the figure to the right depicts a “sinking” input. To properly connect the external supply, you will have to connect it so the input provides a path to ground (-). Start at the PLC input terminal, follow through the input sensing circuit, exit at the common terminal, and connect the supply (-) to the common terminal. By adding the switch, between the supply (+) and the input, the circuit has been completed. Current flows in the direction of the arrow when the switch is closed.

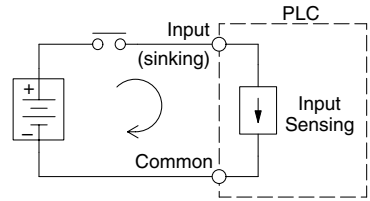

Apply the circuit principle above to the four possible combinations of input/output sinking/sourcing types as shown below. The I/O module specifications at the end of this chapter list the input or output type.

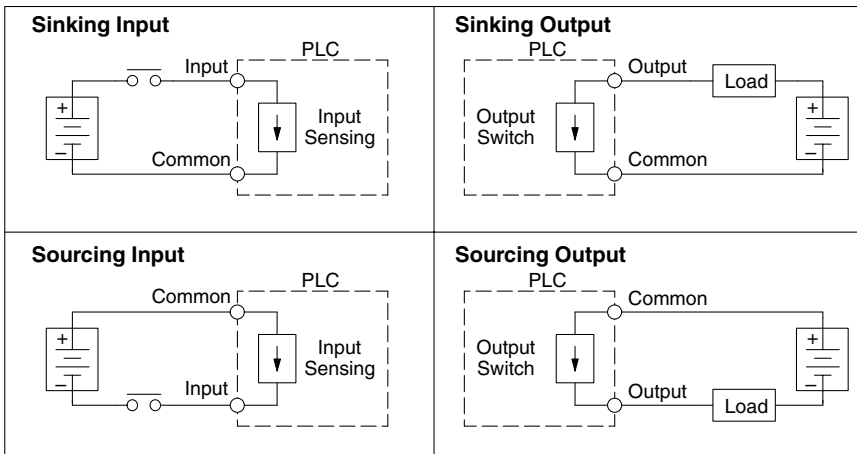

I/O "Common" Terminal Concepts

In order for a PLC I/O circuit to operate, current must enter at one terminal and exit at another. Therefore, at least two terminals are associated with every I/O point. In the figure to the right, the Input or Output terminal is the main path for the current. One additional terminal must provide the return path to the power supply.

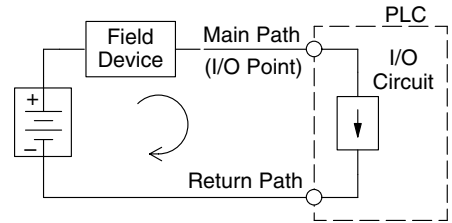

If there was unlimited space and budget for I/O terminals, every I/O point could have two dedicated terminals as the figure above shows. However, providing this level of flexibility is not practical or even necessary for most applications. So, most Input or Output points on PLCs are in groups which share the return path (called commons). The figure to the right shows a group (or bank) of four input points which share a common return path. In this way, the four inputs require only five terminals instead of eight.

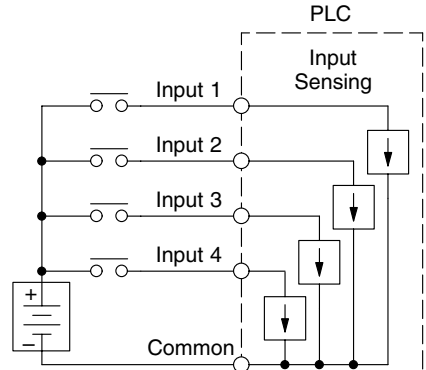

NOTE: In the circuit above, the current in the common path is 4 times any channel's input current when all inputs are energized. This is especially important in output circuits, where heavier gauge wire is sometimes necessary on commons.

Most DL205 input and output modules group their I/O points into banks that share a common return path. The best indication of I/O common grouping is on the wiring label, such as the one shown to the right. There are two circuit banks with eight input points in each. The common terminal for each is labeled "CA" and "CB", respectively.

In the wiring label example, the positive terminal of a DC supply connects to the common terminals. Some symbols you will see on the wiring labels, and their meanings are:

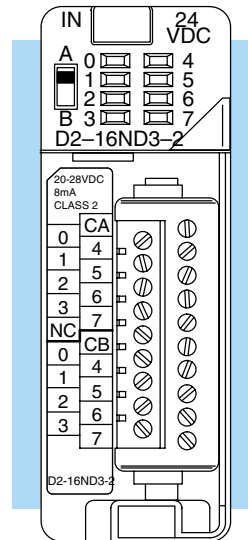
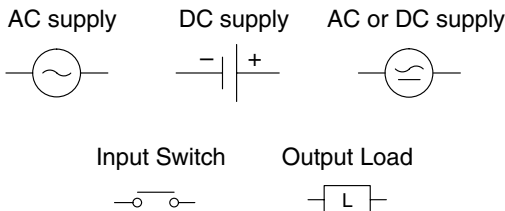

Connecting DC I/O to “Solid State” Field Devices

In the previous section on Sourcing and Sinking concepts, the DC I/O circuits were explained to sometimes only allow current to flow one way. This is also true for many of the field devices which have solid-state (transistor) interfaces. In other words, field devices can also be sourcing or sinking. When connecting two devices in a series DC circuit, one must be wired as sourcing and the other as sinking.

Solid State Input Sensors

Several DL205 DC input modules are flexible because they detect current flow in either direction, so they can be wired as either sourcing or sinking. In the following circuit, a field device has an open-collector NPN transistor output. It sinks current from the PLC input point, which sources current. The power supply can be the +24 auxiliary supply or another supply (+12VDC or +24VDC), as long as the input specifications are met.

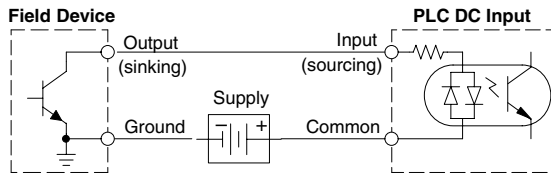

In the next circuit, a field device has an open-collector PNP transistor output. It sources current to the PLC input point, which sinks the current back to ground. Since the field device is sourcing current, no additional power supply is required.

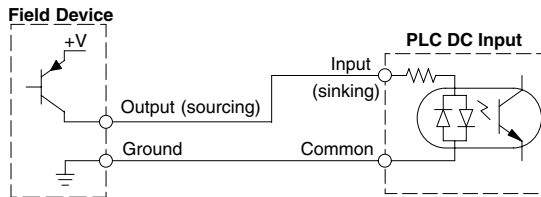

Solid State Output Loads

Sometimes an application requires connecting a PLC output point to a solid state input on a device. This type of connection is usually made to carry a low-level control signal, not to send DC power to an actuator.

Several of the DL205 DC output modules are the sinking type. This means that each DC output provides a path to ground when it is energized. In the following circuit, the PLC output point sinks current to the output common when energized. It is connected to a sourcing input of a field device input.

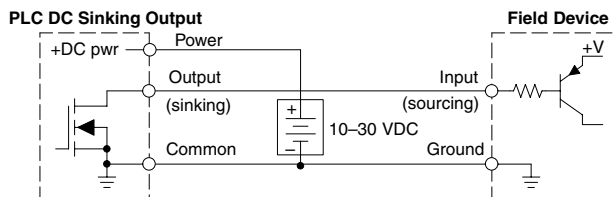

Chapter 2: Installation, Wiring and Specifications

In the next example a PLC sinking DC output point is connected to the sinking input of a field device. This is a little tricky, because both the PLC output and field device input are sinking type. Since the circuit must have one sourcing and one sinking device, a sourcing capability needs to be added to the PLC output by using a pull-up resistor. In the circuit below, a Rpull-up is connected from the output to the DC output circuit power input.

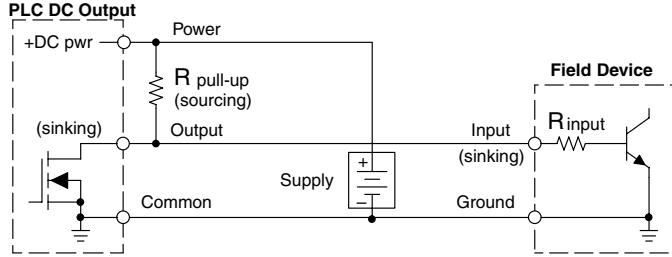

NOTE 1: DO NOT attempt to drive a heavy load (>25mA) with this pull-up method

NOTE 2: Using the pull-up resistor to implement a sourcing output has the effect of inverting the output point logic. In other words, the field device input is energized when the PLC output is OFF, from a ladder logic point of view. Your ladder program must comprehend this and generate an inverted output. Or, you may choose to cancel the effect of the inversion elsewhere, such as in the field device.

It is important to choose the correct value of Rpull-up. In order to do so, you need to know the nominal input current to the field device (Iinput) when the input is energized. If this value is not known, it can be calculated as shown (a typical value is 15mA). Then use Iinput and the voltage of the external supply to compute Rpull-up. Then calculate the power Ppull-up (in watts), in order to size Rpull-up properly.

$$I_{\text{input}} = \frac{V_{\text{input (turn-on)}}}{R_{\text{input}}}$$

$$R_{\text{pull-up}} = \frac{V_{\text{supply}} - 0.7}{I_{\text{input}}} - R_{\text{input}}$$

$$P_{\text{pull-up}} = \frac{V_{\text{supply}}^2}{R_{\text{pull-up}}}$$

Of course, the easiest way to drive a sinking input field device as shown below is to use a DC sourcing output module. The Darlington NPN stage will have about 1.5 V ON-state saturation, but this is not a problem with low-current solid-state loads.

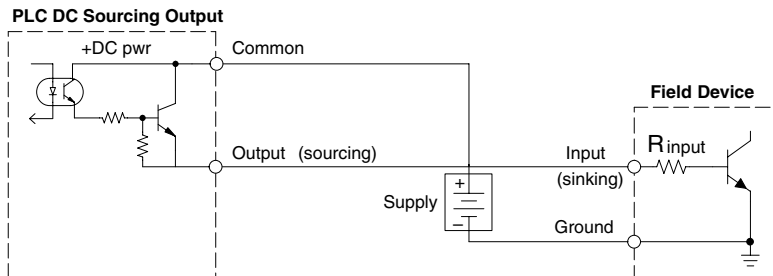

Relay Output Guidelines

Several output modules in the DL205 I/O family feature relay outputs: D2-04TRS, D2-08TR, D2-12TR, D2-08CDR, F2-08TR and F2-08TRS. Relays are best for the following applications:

- Loads that require higher currents than the solid-state outputs can deliver
- Cost-sensitive applications
- Some output channels need isolation from other outputs (such as when some loads require different voltages than other loads)

Some applications in which NOT to use relays:

- Loads that require currents under 10mA
- Loads which must be switched at high speed or heavy duty cycle

Relay outputs in the DL205 output modules are available in two contact arrangements, shown to the right. The Form A type, or SPST (single pole, single throw) type is normally open and is the simplest to use. The Form C type, or SPDT (single pole, double throw) type has a center contact which moves and a stationary contact on either side. This provides a normally closed contact and a normally open contact.

Some relay output module's relays share common terminals, which connect to the wiper contact in each relay of the bank. Other relay modules have relays which are completely isolated from each other. In all cases, the module drives the relay coil when the corresponding output point is on.

Relay with Form A contacts

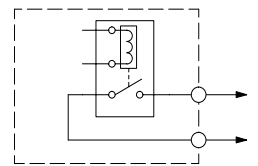

Relay with Form C contacts

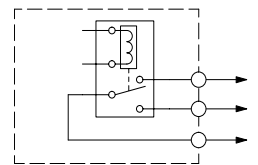

Relay Outputs – Transient Suppression for Inductive Loads in a Control System

The following pages are intended to give a quick overview of the negative effects of transient voltages on a control system and provide some simple advice on how to effectively minimize them. The need for transient suppression is often not apparent to the newcomers in the automation world. Many mysterious errors that can afflict an installation can be traced back to a lack of transient suppression.

What is a Transient Voltage and Why is it Bad?

Inductive loads (devices with a coil) generate transient voltages as they transition from being energized to being de-energized. If not suppressed, the transient can be many times greater than the voltage applied to the coil. These transient voltages can damage PLC outputs or other electronic devices connected to the circuit, and cause unreliable operation of other electronics in the general area. Transients must be managed with suppressors for long component life and reliable operation of the control system.

This example shows a simple circuit with a small 24V/125mA/3W relay. As you can see, when the switch is opened, thereby de-energizing the coil, the transient voltage generated across the switch contacts peaks at 140V.

Example: Circuit with no Suppression

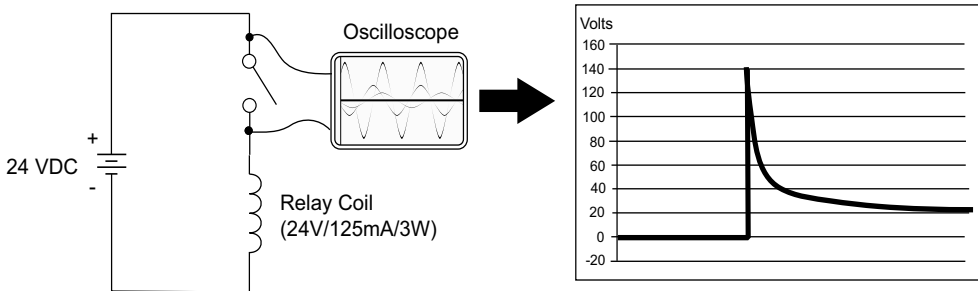

In the same circuit, replacing the relay with a larger 24V/290mA/7W relay will generate a transient voltage exceeding 800V (not shown). Transient voltages like this can cause many problems, including:

- Relay contacts driving the coil may experience arcing, which can pit the contacts and reduce the relay's lifespan.
- Solid state (transistor) outputs driving the coil can be damaged if the transient voltage exceeds the transistor's ratings. In extreme cases, complete failure of the output can occur the very first time a coil is de-energized.
- Input circuits, which might be connected to monitor the coil or the output driver, can also be damaged by the transient voltage.

A very destructive side-effect of the arcing across relay contacts is the electromagnetic interference (EMI) it can cause. This occurs because the arcing causes a current surge, which releases RF energy. The entire length of wire between the relay contacts, the coil, and the power source carries the current surge and becomes an antenna that radiates the RF energy. It will readily couple into parallel wiring and may disrupt the PLC and other electronics in the area. This EMI can make an otherwise stable control system behave unpredictably at times.

PLC's Integrated Transient Suppressors

Although the PLC's outputs typically have integrated suppressors to protect against transients, they are not capable of handling them all. It is usually necessary to have some additional transient suppression for an inductive load.

The next example uses the same 24V/125mA/3W relay used earlier. This example measures the PNP transistor output of a D0-06DD2 PLC, which incorporates an integrated Zener diode for transient suppression. Instead of the 140V peak in the first example, the transient voltage here is limited to about 40V by the Zener diode. While the PLC will probably tolerate repeated transients in this range for some time, the 40V is still beyond the module's peak output voltage rating of 30V.

Example: Small Inductive Load with Only Integrated Suppression

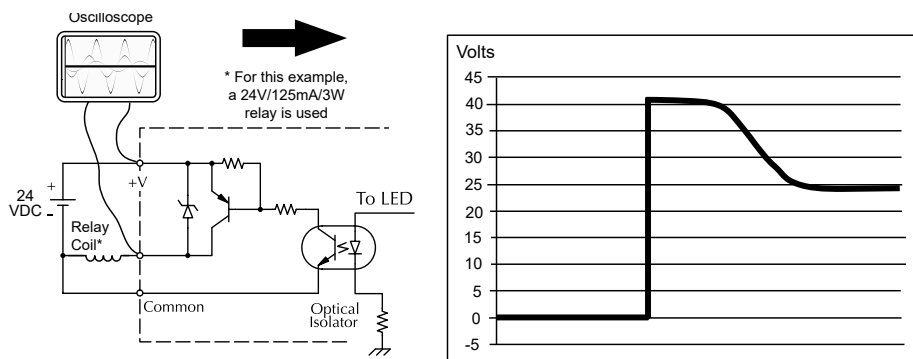

The next example uses the same circuit as above, but with a larger 24V/290mA/7W relay, thereby creating a larger inductive load. As you can see, the transient voltage generated is much worse, peaking at over 50V. Driving an inductive load of this size without additional transient suppression is very likely to permanently damage the PLC output.

Example: Larger Inductive Load with Only Integrated Suppression

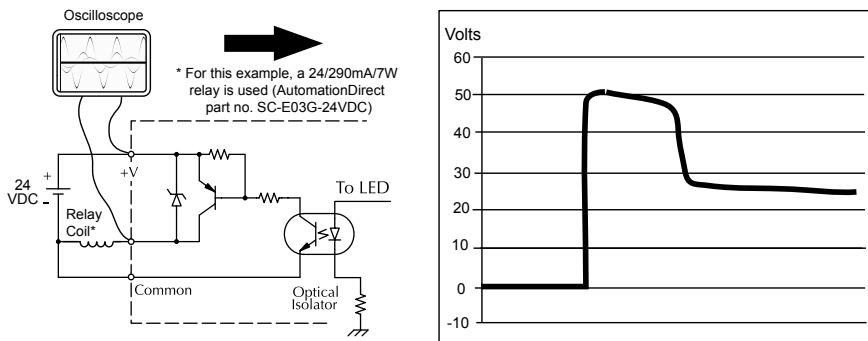

Additional transient suppression should be used in both these examples. If you are unable to measure the transients generated by the connected loads of your control system, using additional transient suppression on all inductive loads would be the safest practice.

Types of Additional Transient Protection

DC Coils:

The most effective protection against transients from a DC coil is a flyback diode. A flyback diode can reduce the transient to roughly 1V over the supply voltage, as shown in this example.

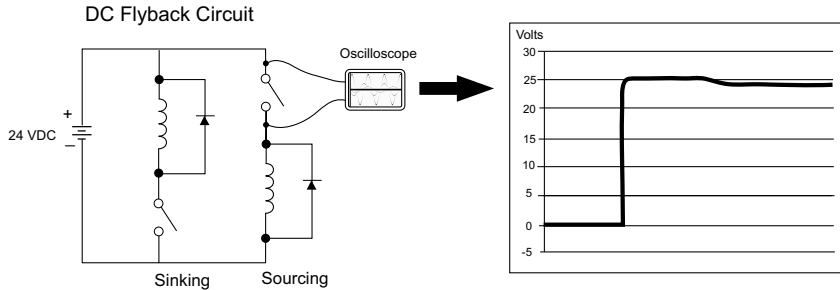

Many AutomationDirect socketed relays and motor starters have add-on flyback diodes that plug or screw into the base, such as the AD-ASMD-250 protection diode module and 784-4C-SKT-1 socket module shown below. If an add-on flyback diode is not available for your inductive load, an easy way to add one is to use AutomationDirect's DN-D10DR-A diode terminal block, a 600VDC power diode mounted in a slim DIN rail housing.



AD-ASMD-250
Protection Diode Module



784-4C-SKT-1
Relay Socket

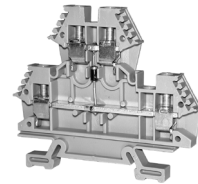

DN-D10DR-A
Diode Terminal Block

Two more common options for DC coils are Metal Oxide Varistors (MOV) or TVS diodes. These devices should be connected across the driver (PLC output) for best protection as shown below. The optimum voltage rating for the suppressor is the lowest rated voltage available that will NOT conduct at the supply voltage, while allowing a safe margin.

AutomationDirect's ZL-TSD8-24 transorb module is a good choice for 24VDC circuits. It is a bank of 8 uni-directional 30V TVS diodes. Since they are uni-directional, be sure to observe the polarity during installation. MOVs or bi-directional TVS diodes would install at the same location, but have no polarity concerns.



DC MOV or TVS Diode Circuit

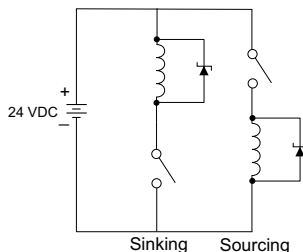

AC Coils:

Two options for AC coils are MOVs or bi-directional TVS diodes. These devices are most effective at protecting the driver from a transient voltage when connected across the driver (PLC output) but are also commonly connected across the coil. The optimum voltage rating for the suppressor is the lowest rated voltage available that will NOT conduct at the supply voltage, while allowing a safe margin.

AutomationDirect's ZL-TSD8-120 transorb module is a good choice for 120VAC circuits. It is a bank of eight bi-directional 180V TVS diodes.



AC MOV or Bi-Directional Diode Circuit

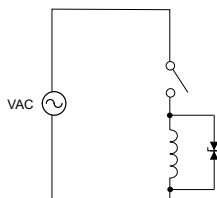

NOTE: Manufacturers of devices with coils frequently offer MOV or TVS diode suppressors as an add-on option which mount conveniently across the coil. Before using them, carefully check the suppressor's ratings. Just because the suppressor is made specifically for that part does not mean it will reduce the transient voltages to an acceptable level.

For example, a MOV or TVS diode rated for use on 24-48 VDC coils would need to have a high enough voltage rating to NOT conduct at 48V. That suppressor might typically start conducting at roughly 60VDC. If it were mounted across a 24V coil, transients of roughly 84V (if sinking output) or -60V (if sourcing output) could reach the PLC output. Many semiconductor PLC outputs cannot tolerate such levels.

I/O Module Positioning, Wiring, and Specification

Slot Numbering

The DL205 bases each provide different numbers of slots for use with the I/O modules. You may notice the bases refer to 3-slot, 4-slot, etc. One of the slots is dedicated to the CPU, so you always have one less I/O slot. For example, you have five I/O slots with a 6-slot base. The I/O slots are numbered 0–4. The CPU slot always contains a PLC CPU or other CPU–slot controller and is not numbered.

Module Placement Restrictions

The following table lists the valid locations for all types of modules in a DL205 system:

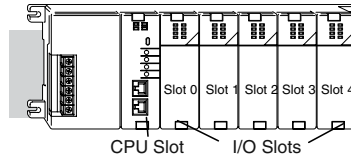

Module/Unit	Local CPU Base	Local Expansion Base	Remote I/O Base
CPUs	CPU Slot Only		
DC Input Modules	A	A	A
AC Input Modules	A	A	A
DC Output Modules	A	A	A
AC Output Modules	A	A	A
Relay Output Modules	A	A	A
Analog Input and Output Modules	A	A	A
Local Expansion			
Base Expansion Module	A	A	
Base Controller Module		CPU Slot Only	
Serial Remote I/O			
Remote Master	A		
Remote Slave Unit			CPU Slot Only
Ethernet Remote Master	A		
CPU Interface			
Ethernet Base Controller	Slot 0 Only		Slot 0 Only*
WinPLC	Slot 0 Only		
DeviceNet	Slot 0 Only		
Profibus	Slot 0 Only		
SDS	Slot 0 Only		
Specialty Modules			
Counter Interface **	Slot 0 Only		
Counter I/O	A		A*
Data Communications	A		
Ethernet Communications	A		
BASIC CoProcessor	A		
Simulator	A	A	A
Filler	A	A	A

* When used with H2-ERM(100) Ethernet Remote I/O system. ** D2-262 does not support D2-CTRINT module.

Special Placement Considerations for Analog Modules

In most cases, the analog modules can be placed in any slot. However, the placement can also depend on the type of CPU you are using and the other types of modules installed to the left of the analog modules. If you're using a D2-230 CPU (or a D2-240 CPU with firmware earlier than V1.4) you should check the DL205 Analog I/O Manual for any possible placement restrictions related to your particular module. You can download the DL205 Analog I/O Manual (part number D2-ANLG-M) from automationdirect.com.

Discrete Input Module Status Indicators

The discrete modules provide LED status indicators to show the status of the input points.

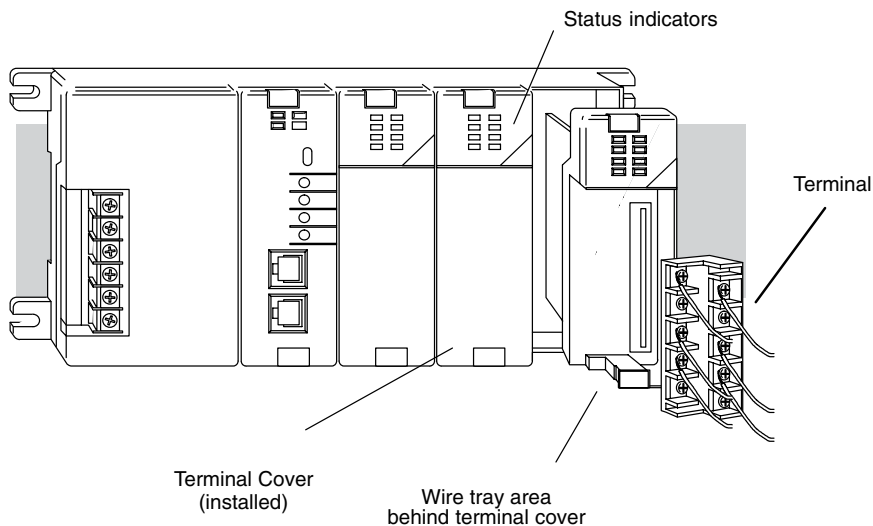

Color Coding of I/O Modules

The DL205 family of I/O modules have a color coding scheme to help you quickly identify if a module is either an input module, output module, or a specialty module. This is done through a color bar indicator located on the front of each module. The color scheme is listed below:

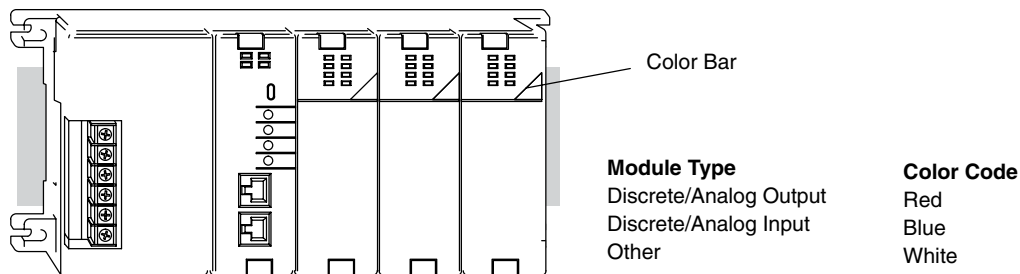

Wiring the Different Module Connectors

There are two types of module connectors for the DL205 I/O. Some modules have normal screw terminal connectors. Other modules have connectors with recessed screws. The recessed screws help minimize the risk of someone accidentally touching active wiring.

Both types of connectors can be easily removed. If you examine the connectors closely, you'll notice there are squeeze tabs on the top and bottom. To remove the terminal block, press the squeeze tabs and pull the terminal block away from the module.

We also have DIN rail mounted terminal blocks, DINnectors (refer to our catalog for a complete listing of all available products). ZIPLinks come with special pre-assembled cables with the I/O connectors installed and wired.



WARNING: For some modules, field device power may still be present on the terminal block even though the PLC system is turned off. To minimize the risk of electrical shock, check all field device power before you remove the connector.

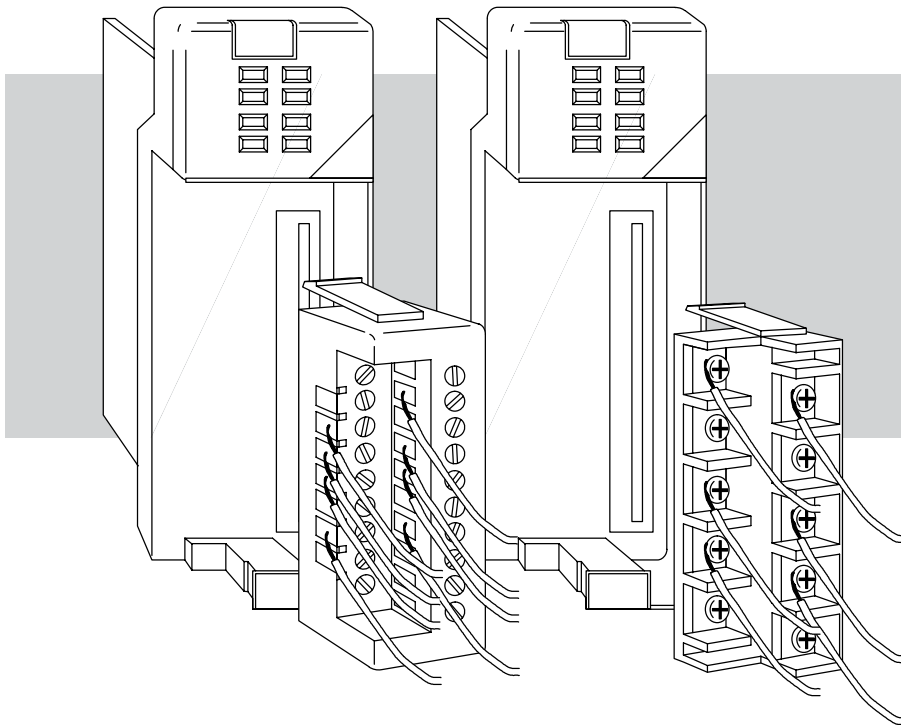

I/O Wiring Checklist

Use the following guidelines when wiring the I/O modules in your system.

1. There is a limit to the size of wire the modules can accept. The table below lists the suggested AWG for each module type. When making terminal connections, follow the suggested torque values.

Terminal type	Suggested AWG Range	Suggested Torque
10-Terminal Fixed	14 – 24 AWG	3.5 lb-inch (0.4 N-m)
10-Terminal Removable	16* – 24 AWG	7.81 lb-inch (0.88 N-m)
20-Terminal Removable	16* – 24 AWG	2.65 lb-in (0.3 N-m)



***NOTE:** 16 AWG Type TFFN or Type MTW is recommended. Other types of 16 AWG may be acceptable, but it really depends on the thickness and stiffness of the wire insulation. If the insulation is too thick or stiff and a majority of the module's I/O points are used, then the plastic terminal cover may not close properly or the connector may pull away from the module. This applies especially for high temperature thermoplastics such as THHN.

2. Always use a continuous length of wire, do not combine wires to attain a needed length.
3. Use the shortest possible wire length.
4. Use wire trays for routing where possible.
5. Avoid running wires near high energy wiring. Also, avoid running input wiring close to output wiring where possible.
6. To minimize voltage drops when wires must run a long distance, consider using multiple wires for the return line.
7. Avoid running DC wiring in close proximity to AC wiring where possible.
8. Avoid creating sharp bends in the wires.
9. To reduce the risk of having a module with a blown fuse, we suggest you add external fuses to your I/O wiring. A fast blow fuse, with a lower current rating than the I/O module fuse can be added to each common, or a fuse with a rating of slightly less than the maximum current per output point can be added to each output. Refer to our catalog for a complete line of DINnectors, DIN-rail mounted fuse blocks.

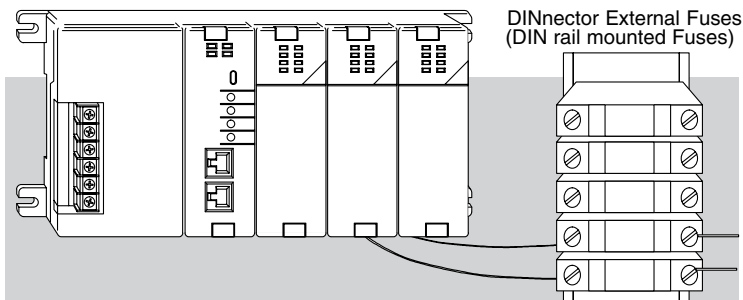

DL205 I/O Module Specifications

The tables below list the Input and Output modules for the DL205 PLC system. Specifications for each module begin on the following page.

DL205 Input Module Chart

Modules Types	Number of Input Points	DC Current Sink Input	DC Current Source Input	AC Input
D2-08ND3	8	√	√	–
D2-16ND3-2	16	√	√	–
D2-32ND3	32	√	√	–
D2-32ND3-2	32	√	√	–
D2-08NA-1	8	–	–	√
D2-08NA-2	8	–	–	√
D2-16NA	16	–	–	√
F2-08SIM	8	–	–	–
D2-08CDR*	4	√	√	–

* D2-08CDR is a combo module, 4 pt. DC Input and 4 pt. Relay Output

DL205 Output Module Chart

Modules Types	Number of Output Points	DC Current Sink Output	DC Current Source Output	AC Output
D2-04TD1	4	√	–	–
D2-08TD1	8	√	–	–
D2-08TD2	8	–	√	–
D2-16TD1-2	16	√	–	–
D2-16TD2-2	16	–	√	–
F2-16TD1P	16	√	–	–
F2-16TD2P	16	–	√	–
D2-32TD1	32	√	–	–
D2-32TD2	32	–	√	–
F2-08TA	8	–	–	√
D2-08TA	8	–	–	√
D2-12TA	12	–	–	√
D2-04TRS	4	√	√	√
D2-08TR	8	√	√	√
F2-08TR	8	√	√	√
F2-08TRS	8	√	√	√
D2-12TR	12	√	√	√
D2-08CDR*	4	√	√	√

* D2-08CDR is a combo module, 4 pt. DC Input and 4 pt. Relay Output

D2-08ND3, DC Input

D2-08ND3 DC Input	
Inputs per Module	8 (sink/source)
Commons per Module	1 (2 I/O terminal points)
Input Voltage Range	10.2–26.4 VDC
Peak Voltage	26.4 VDC
ON Voltage Level	9.5 VDC minimum
OFF Voltage Level	3.5 VDC maximum
AC Frequency	N/A
Input Impedance	2.7 kΩ
Input Current	4.0 mA @ 12VDC 8.5 mA @ 24VDC
Minimum ON Current	3.5 mA
Maximum OFF Current	1.5 mA
Base Power Required 5VDC	50mA
OFF to ON Response	1 to 8 ms
ON to OFF Response	1 to 8 ms
Terminal Type (included)	Removable, D2-8IOCON
Status Indicator	Logic side
Weight	2.3 oz. (65g)

D2-16ND3-2, DC Input

D2-16ND3-2 DC Input	
Inputs per Module	16 (sink/source)
Commons per Module	2 isolated (8 I/O terminal points/com)
Input Voltage Range	20–28 VDC
Peak Voltage	30VDC (10mA)
ON Voltage Level	19 VDC minimum
OFF Voltage Level	7VDC maximum
AC Frequency	N/A
Input Impedance	3.9 kΩ
Input Current	6mA @ 24VDC
Minimum ON Current	3.5 mA
Maximum OFF Current	1.5 mA
Base Power Required 5VDC	100mA
OFF to ON Response	3 to 9 ms
ON to OFF Response	3 to 9 ms
Terminal Type (included)	Removable, D2-16IOCON
Status Indicator	Logic side
Weight	2.3 oz. (65g)

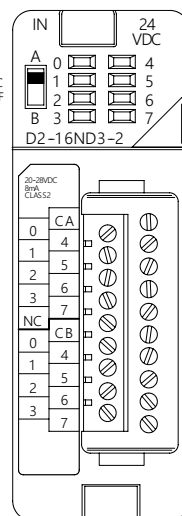
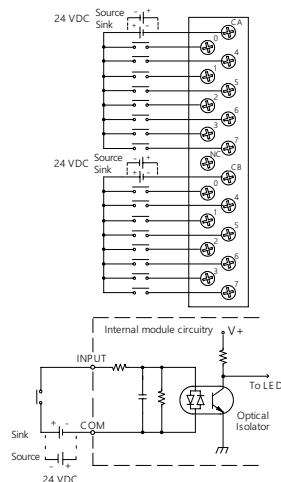
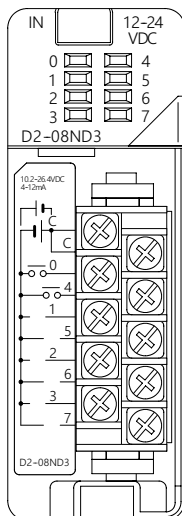
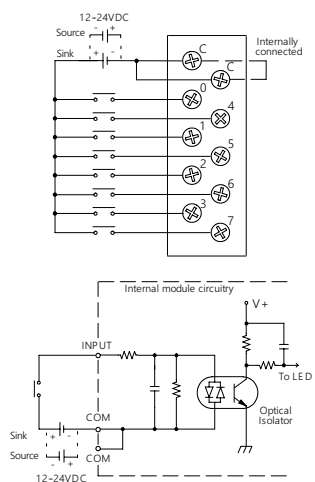
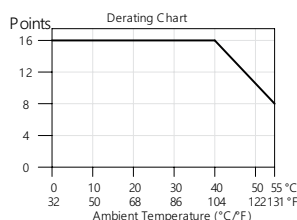
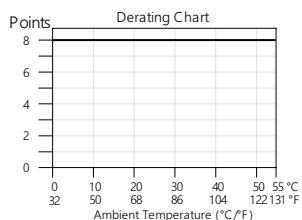

D2-32ND3, DC Input

D2-32ND3 DC Input	
Inputs per Module	32 (sink/source)
Commons per Module	4 isolated (8 I/O terminal points / com)
Input Voltage Range	20-28 VDC
Peak Voltage	30VDC
ON Voltage Level	19VDC minimum
OFF Voltage Level	7VDC maximum
AC Frequency	N/A
Input Impedance	4.8 k Ω
Input Current	8.0 mA @ 24 VDC
Minimum ON Current	3.5 mA
Maximum OFF Current	1.5 mA
Base Power Required 5VDC	25mA
OFF to ON Response	3 to 9 ms
ON to OFF Response	3 to 9 ms
Terminal Type (not included)	40-pin Connector1
Status Indicator	Module Activity LED
Weight	2.1 oz. (60 g)

1 Connector sold separately. See Terminal Blocks and Wiring for wiring options.

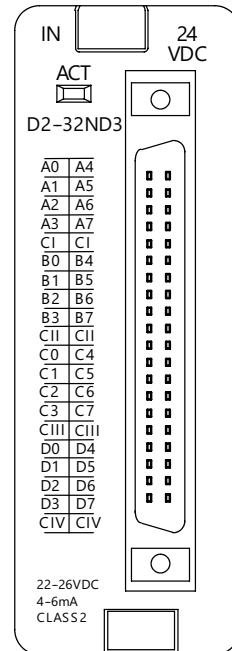
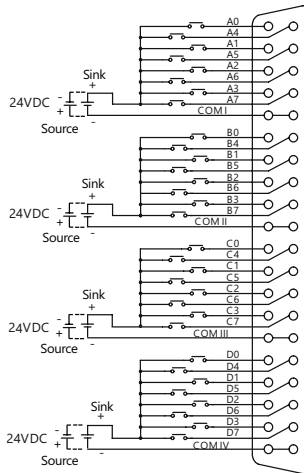
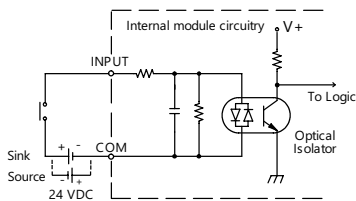
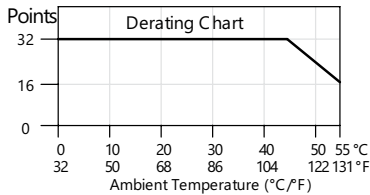

D2-32ND3-2, DC Input

D2-32ND3-2 DC Input	
Inputs per Module	32 (Sink/Source)
Commons per Module	4 isolated (8 I/O terminal points / com)
Input Voltage Range	4.50 to 15.6 VDC min. to max.
Peak Voltage	16VDC
ON Voltage Level	4VDC minimum
OFF Voltage Level	2VDC maximum
AC Frequency	N/A
Input Impedance	1.0 kΩ @ 5-5 VDC
Input Current	4mA @ 5VDC 11mA @ 12VDC 14mA @ 15VDC
Maximum Input Current	16mA @ 15.6 VDC
Minimum ON Current	3mA
Maximum OFF Current	0.5 mA
Base Power Required 5VDC	25mA
OFF to ON Response	3 to 9 ms
ON to OFF Response	3 to 9 ms
Terminal Type (not included)	40-pin connector ¹
Status Indicator	Module activity LED
Weight	2.1 oz. (60g)

1. Connector sold separately. See Terminal Blocks and Wiring for wiring options.

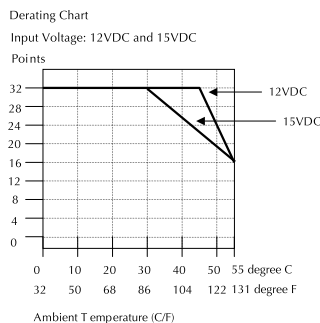
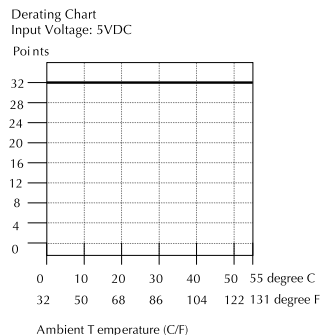
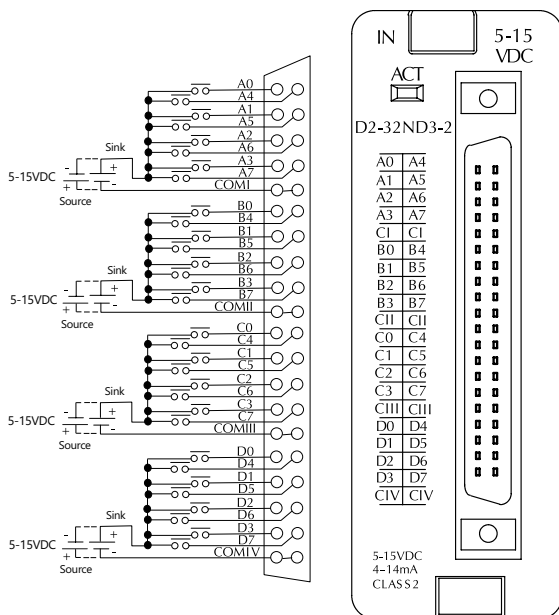

D2-08NA-1, AC Input

D2-08NA-1 AC Input	
Inputs per Module	8
Commons per Module	1 (2 I/O terminal points)
Input Voltage Range	80–132 VAC
Peak Voltage	132VAC
ON Voltage Level	75VAC minimum
OFF Voltage Level	20VAC maximum
AC Frequency	47–63 Hz
Input Impedance	12kΩ @ 60Hz
Input Current	13mA @ 100VAC, 60Hz 11mA @ 100 VAC, 50Hz
Minimum ON Current	5mA
Maximum OFF Current	2mA
Base Power Required 5VDC	50mA
OFF to ON Response	5 to 30 ms
ON to OFF Response	10 to 50 ms
Terminal Type (included)	Removable; D2-8IOCON
Status Indicator	Logic side
Weight	2.5 oz. (70g)

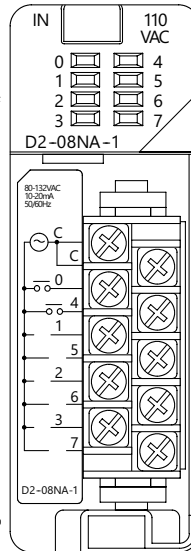
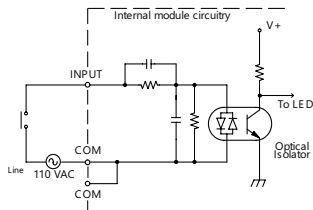
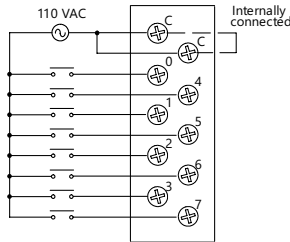
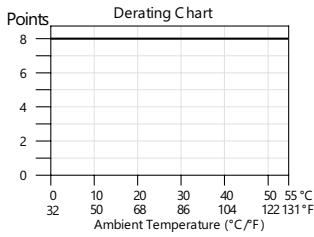

D2-08NA-2, AC Input

D2-08NA-2 AC Input	
Inputs per Module	8
Commons per Module	1 (2 I/O terminal points)
Input Voltage Range	170–265 VAC
Peak Voltage	265VAC
ON Voltage Level	150VAC minimum
OFF Voltage Level	40VAC maximum
AC Frequency	47–63 Hz
Input Impedance	18kΩ @ 60Hz
Input Current	9mA @ 220VAC, 50Hz 11mA @ 265VAC, 50Hz 10mA @ 220VAC, 60Hz 12mA @ 265VAC, 60Hz
Minimum ON Current	10mA
Maximum OFF Current	2mA
Base Power Required 5VDC	100mA
OFF to ON Response	5 to 30 ms
ON to OFF Response	10 to 50 ms
Terminal Type (included)	Removable; D2-8IOCON
Status Indicator	Logic side
Weight	2.5 oz. (70g)

Operating Temperature	32°F to 131°F (0° to 55°C)
Storage Temperature	-4°F to 158°F (-20°C to 70°C)
Humidity	35% to 95% (non-condensing)
Atmosphere	No corrosive gases permitted
Vibration	MIL STD 810C 514.2
Shock	MIL STD 810C 516.2
Insulation Withstand Voltage	1,500VAC 1 minute (COM-GND)
Insulation Resistance	10MΩ @ 500VDC
Noise Immunity	NEMA 1,500V 1 minute SANKI 1,000V 1 minute
RFI	150MHz, 430MHz

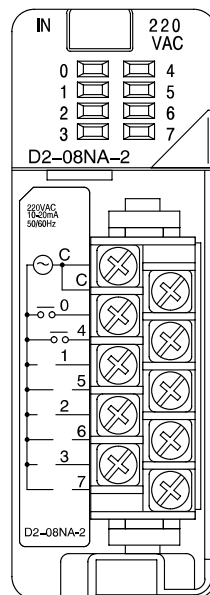
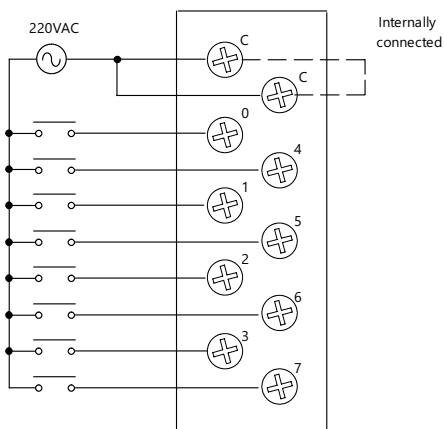
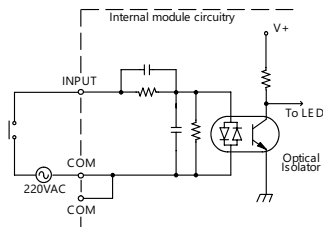
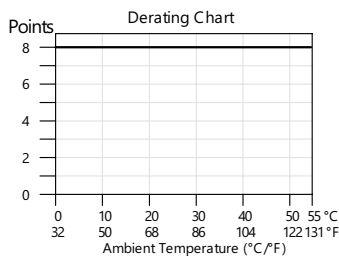

D2-16NA, AC Input

D2-16NA AC Input	
Inputs per Module	16
Commons per Module	2 (isolated)
Input Voltage Range	80–132 VAC
Peak Voltage	132VAC
ON Voltage Level	70VAC minimum
OFF Voltage Level	20VAC maximum
AC Frequency	47–63 Hz
Input Impedance	12kΩ @ 60Hz
Input Current	11mA @ 100VAC, 50Hz 13mA @ 100VAC, 60Hz 15mA @ 132VAC, 60Hz
Minimum ON Current	5mA
Maximum OFF Current	2mA
Base Power Required 5VDC	100mA
OFF to ON Response	5 to 30 ms
ON to OFF Response	10 to 50 ms
Terminal Type (included)	Removable; D2-16IOCON
Status Indicator	Logic side
Weight	2.4 oz. (68g)

F2-08SIM, Input Simulator

F2-08SIM Input Simulator	
Inputs per Module	8
Base Power Required 5VDC	50mA
Terminal Type	None
Status Indicator	Switch side
Weight	2.65 oz. (75g)

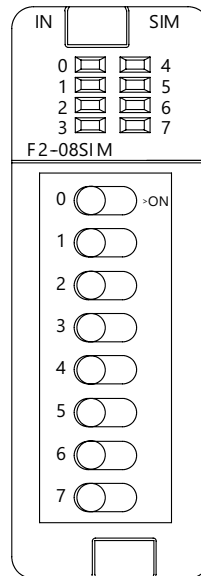
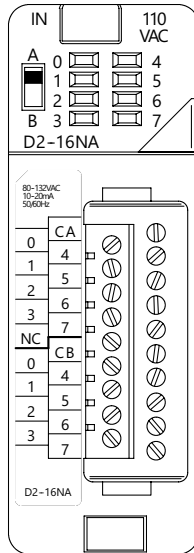
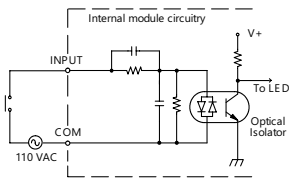
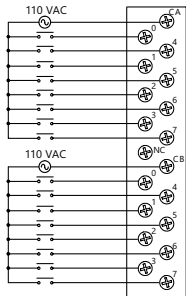
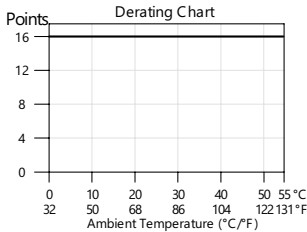

D2-04TD1, DC Output

D2-04TD1 DC Output	
Outputs per Module	4 (current sinking)
Output Points Consumed	8 points (only first 4 pts. used)
Commons per Module	1 (4 I/O terminal points)
Output Type	NMOS FET (open drain)
Operating Voltage	10.2-26.4 VDC
Peak Voltage	40VDC
ON Voltage Drop	0.72 VDC maximum
AC Frequency	N/A
Max Load Current (resistive)	4A/point 8A/common
Max Leakage Current	0.1 mA @ 40 VDC
Max Inrush Current	6A for 100 ms, 15A for 10ms
Minimum Load Current	50mA

External DC Required	24VDC @ 20mA max.
Base Power Required 5VDC	60mA
OFF to ON Response	1ms
ON to OFF Response	1ms
Terminal Type (included)	Removable; D2-8IOCON
Status Indicator	Logic side
Weight	2.8 oz. (80g)
Fuses	4 (1 per point) (6.3 A slow blow, non-replaceable)

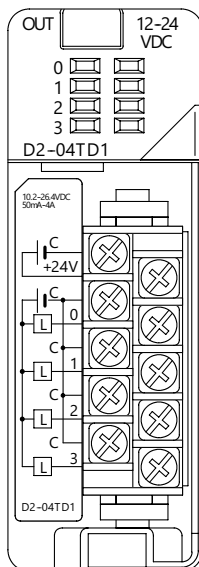
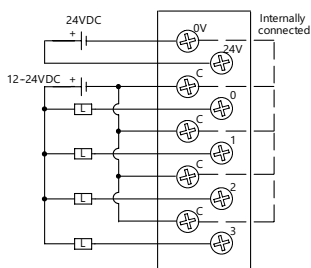
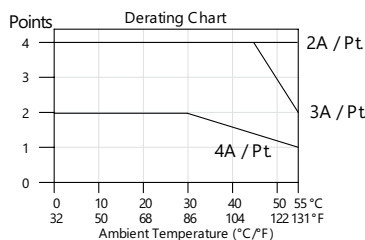

Inductive Load
Maximum Number of Switching Cycles per Minute

Load Current	Duration of output in ON state		
	7ms	40ms	100ms
0.1A	8000	1400	600
0.5A	1600	300	120
1.0A	800	140	60
1.5A	540	90	35
2.0A	400	70	-
3.0A	270	-	-
4.0A	200	-	-

At 40ms duration, loads of 3.0 A or greater cannot be used.
At 100ms duration, loads of 2.0 A or greater cannot be used.
Find the load current you expect to use and the duration that the output is ON. The number at the intersection of the row and column represents the switching cycles per minute. For example, a 1A inductive load that is on for 100ms can be switched on and off a maximum of 60 times per minute. To convert this to duty cycle percentage use: (duration x cycles)/60. In this example, (60 x .1)/60 = .1, or 10% duty cycle.

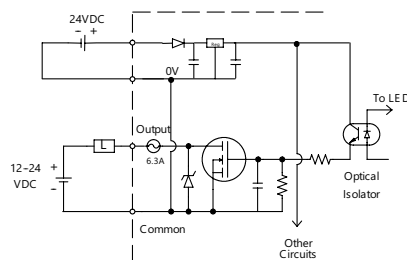

D2-08TD1, DC Output

D2-08TD1 DC Output	
Outputs per Module	8 (current sinking)
Commons per Module	1 (2 I/O terminal points)
Output Type	NPN open collector
Operating Voltage	10.2–26.4 VDC
Peak Voltage	40VDC
ON Voltage Drop	1.5 VDC maximum
AC Frequency	N/A
Minimum Load Current	0.5 mA
Max Load Current	0.3 A/point; 2.4 A/common
Max Leakage Current	0.1 mA @ 40VDC
Max Inrush Current	1A for 10ms
Base Power Required 5VDC	100mA
OFF to ON Response	1ms
ON to OFF Response	1ms
Terminal Type (included)	Removable; D2-8IOCON
Status Indicator	Logic side
Weight	2.3 oz. (65g)
Fuses	1 per common 5A fast blow, non-replaceable

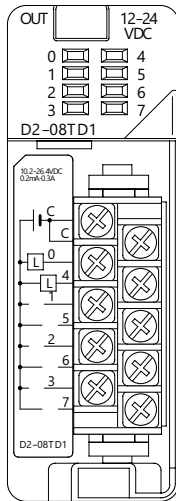
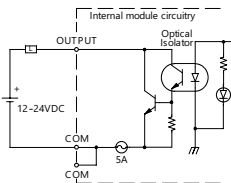
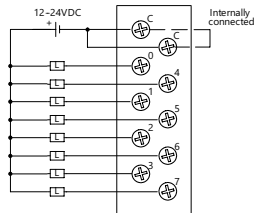
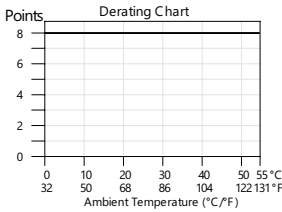

D2-08TD2, DC Output

D2-08TD2 DC Output	
Outputs per Module	8 (current sourcing)
Commons per Module	1
Output Type	PNP open collector
Operating Voltage	12–24 VDC
Output Voltage	10.8–26.4 VDC
Peak Voltage	40VDC
ON Voltage Drop	1.5 VDC
AC Frequency	N/A
Minimum Load Current	N/A
Max Load Current	0.3 A per point; 2.4 A per common
Max Leakage Current	1.0 mA @ 40VDC
Max Inrush Current	1A for 10 ms
Base Power Required 5VDC	100 mA
OFF to ON Response	1ms
ON to OFF Response	1ms
Terminal Type (included)	Removable; D2-8IOCON
Status Indicator	Logic side
Weight	2.1 oz. (60g)
Fuse	5A fast blow, non-replaceable

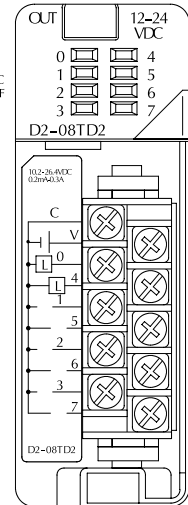
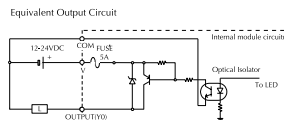
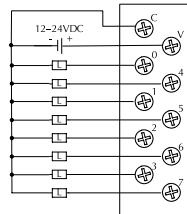
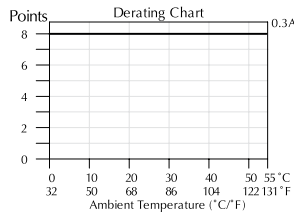

D2-16TD1-2, DC Output

D2-16TD1-2 DC Output	
Outputs per Module	16 (current sinking)
Commons per Module	1 (2 I/O terminal points)
Output Type	NPN open collector
External DC required	24VDC \pm 4V @ 80mA max
Operating Voltage	10.2-26.4 VDC
Peak Voltage	30VDC
ON Voltage Drop	0.5 VDC maximum
AC Frequency	N/A
Minimum Load Current	0.2 mA
Max Load Current	0.1 A/point 1.6 A/common
Max Leakage Current	0.1 mA @ 30 VDC
Max Inrush Current	150mA for 10 ms
Base Power Required 5VDC	200mA
OFF to ON Response	0.5 ms
ON to OFF Response	0.5 ms
Terminal Type (included)	Removable; D2-16IO-CON
Status Indicator	Logic side
Weight	2.3 oz. (65g)
Fuses	None

D2-16TD2-2, DC Output

D2-16TD2-2 DC Output	
Outputs per Module	16 (current sourcing)
Commons per Module	2
Output Type	NPN open collector
Operating Voltage	10.2-26.4 VDC
Peak Voltage	30VDC
ON Voltage Drop	1.0 VDC maximum
AC Frequency	N/A
Minimum Load Current	0.2 mA
Max Load Current	0.1 A/point 1.6 A/ module
Max Leakage Current	0.1 mA @ 30 VDC
Max Inrush Current	150mA for 10 ms
Base Power Required 5VDC	200mA
OFF to ON Response	0.5 ms
ON to OFF Response	0.5 ms
Terminal Type (included)	Removable; D2-16IO-CON
Status Indicator	Logic side
Weight	2.8 oz. (80g)
Fuses	None

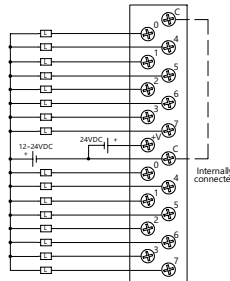
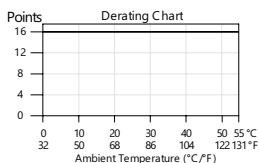

* Can also be used with 5VDC supply

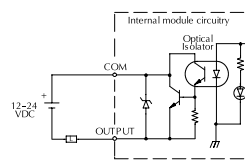
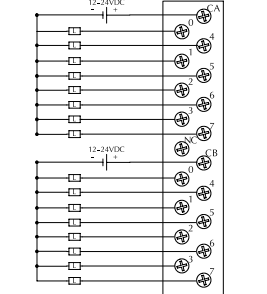
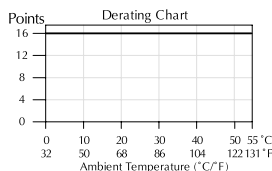

F2-16TD1(2)P, DC Output With Fault Protection



NOTE: Not supported in D2-230, D2-240 and D2-250 CPUs.

These modules detect the following fault status and turn the related X bit(s) on.

1. Missing external 24VDC for the module
2. Open load¹
3. Over temperature (the output is shut down)
4. Over load current (the output is shut down)

Fault Status	X bit Fault Status Indication
Missing external 24VDC	All 16 X bits are on.
Open load ¹	Only the X bit assigned to the faulted output is on
Over temperature	
Over load current	

When these modules are installed, 16 X bits are automatically assigned as the fault status indicator. Each X bit indicates the fault status of each output.

In this example, X10-X27 are assigned as the fault status indicator.

- X10: Fault status indicator for Y0
- X11: Fault status indicator for Y1

↓ ...

- X26: Fault status indicator for Y16
- X27: Fault status indicator for Y17

The fault status indicators (X bits) can be reset by performing the indicated operations in the following table:

Fault Status	Operation
Missing external 24VDC	Apply external 24VDC
Open load ¹	Connect the load.
Over temperature	Turn the output (Y bit) off or power cycle the PLC
Over load current	



NOTE 1: Open load detection can be disabled by removing the jumper switch J6 on the module PC board.

Example

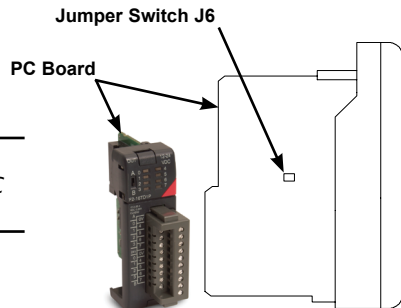
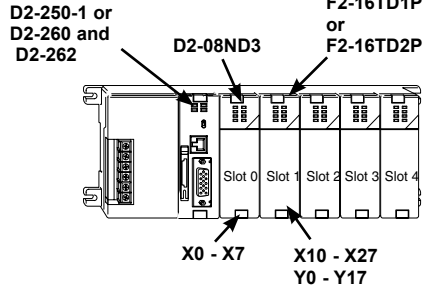

Continued on next two pages.

F2-16TD1P, DC Output With Fault Protection



NOTE: Not supported in D2-230, D2-240 and D2-250 CPUs.



NOTE: Supporting Firmware:
D2-250-1 must be v4.80 or later
D2-260 must be v2.60 or later
D2-262 must be v1.00 or later

F2-16TD1P DC Output with Fault Protection	
Inputs per module	16 (status indication)
Outputs per module	16 (current sinking)
Commons per module	1 (2 I/O terminal points)
Output type	NMOS FET (open drain)
Operating voltage	10.2–26.4 VDC, external
Peak voltage	40VDC
AC frequency	N/A
ON voltage drop	0.7 V (output current 0.5 A)
Overcurrent trip	0.6 A, min., 1.2A, max.
Minimum load current	0.2 mA
Maximum load current	0.25 A/point; 4A/common
Max leakage current	0.2 mA (load detect enabled); 0.3 mA disabled
Max inrush current	150mA for 10ms
Base power required 5V	70mA
OFF to ON response	0.5 ms
ON to OFF response	0.5 ms
Terminal type	Removable (D2-16IO-CON)
Status indicators	Logic Side
Weight	2.0 oz. (25g)
Fuses	None
External DC required	24VDC ±10% @ 50mA
External DC overvoltage shutdown	27V, outputs are re-stored when voltage is within limits

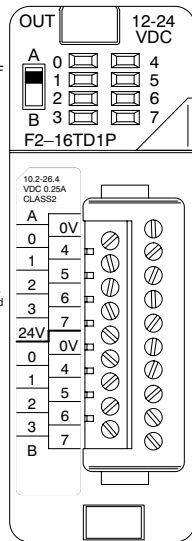
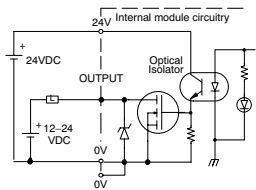
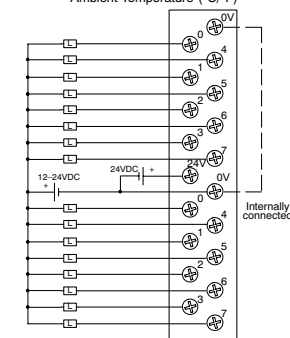
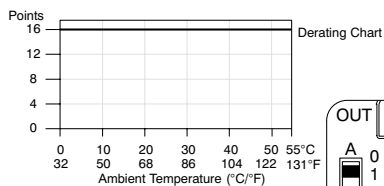

When the A/B switch is in the A position, the LEDs display the output status of the module's first 8 output points. Position B displays the output status of the module's second group of 8 output points.

F2-16TD2P, DC Output with Fault Protection



NOTE: Not supported in D2-230, D2-240 and D2-250 CPUs.



NOTE: Supporting Firmware: D2-250-1 must be v4.80 or later D2-260 must be v2.60 or later D2-262 must be v1.00 or later.

F2-16TD2P DC Output with Fault Protection

Inputs per module	16 (status indication)
Outputs per module	16 (current sourcing)
Commons per module	1
Output type	NMOS FET (open source)
Operating voltage	10.2–26.4 VDC, external
Peak voltage	40VDC
AC frequency	N/A
ON voltage drop	0.7 V (output current 0.5 A)
Overcurrent trip	0.6 A min., 1.2 A max.
Minimum load current	0.2 mA
Maximum load current	0.25 A/point; 4A/common
Max leakage current	0.2 mA (load detect enabled); 0.3 mA disabled
Max inrush current	150mA for 10ms
Base power required 5V	70mA
OFF to ON response	0.5 ms
ON to OFF response	0.5 ms
Terminal type	Removable (D2-16IOCON)
Status indicators	Logic Side
Weight	2.0 oz. (25g)
Fuses	None
External DC required	24VDC ±10% @ 50mA
External DC overvoltage shutdown	27V, outputs are restored when voltage is within limits

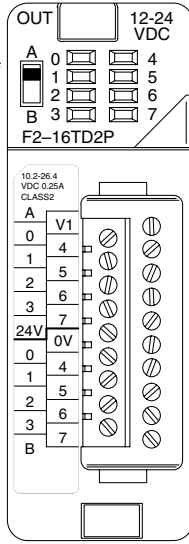
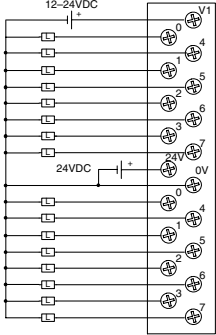
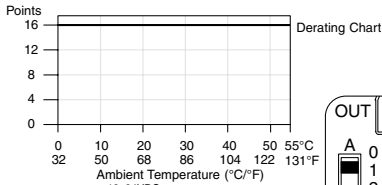

When the A/B switch is in the A position, the LEDs display the output status of the module's first 8 output points. Position B displays the output status of the module's second group of 8 output points.

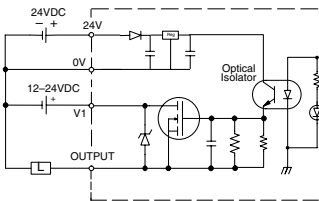

D2-32TD1, DC Output

D2-32TD1 DC Output	
Outputs per Module	32 (current sinking)
Commons per Module	4 (8 I/O terminal points)
Output Type	NPN open collector
Operating Voltage	12–24 VDC
Peak Voltage	30VDC
ON Voltage Drop	0.5 VDC maximum
Minimum Load Current	0.2 mA
Max Load Current	0.1 A/point; 3.2 A per module
Max Leakage Current	0.1 mA @ 30VDC
Max Inrush Current	150mA for 10ms
Base Power Required 5VDC	350mA
OFF to ON Response	0.5 ms
ON to OFF Response	0.5 ms
Terminal Type (not included)	40-pin connector ¹
Status Indicator	Module activity (no I/O status indicators)
Weight	2.1 oz. (60g)
Fuses	None
External DC Power Required	20–28 VDC max. 120mA (all points on)

¹ Connector sold separately.
See Terminal Blocks and Wiring for wiring options.

D2-32TD2, DC Output

D2-32TD2 DC Output	
Outputs per Module	32 (current sourcing)
Commons per Module	4 (8 I/O terminal points)
Output Type	Transistor
Operating Voltage	12 to 24 VDC
Peak Voltage	30VDC
ON Voltage Drop	0.5 VDC @ 0.1 A
Minimum Load Current	0.2 mA
Max Load Current	0.1 A/point; 0.8 A/common
Max Leakage Current	0.1 mA @ 30VDC
Max Inrush Current	150mA @ 10ms
Base Power Required 5VDC	350mA
OFF to ON Response	0.5 ms
ON to OFF Response	0.5 ms
Terminal Type (not included)	40-pin connector ¹
Status Indicator	Module activity (no I/O status indicators)
Weight	2.1 oz (60g)
Fuses	None

¹ Connector sold separately.
See Terminal Blocks and Wiring for wiring options.

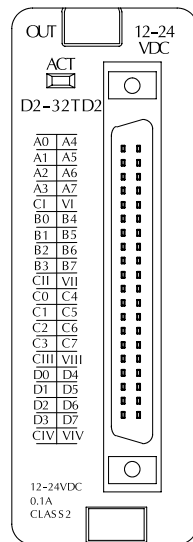
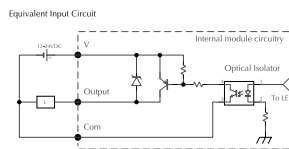
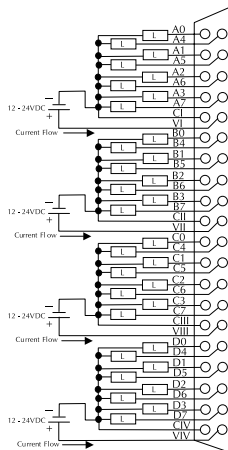
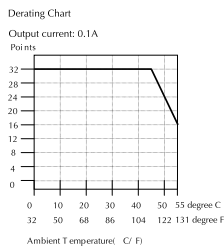
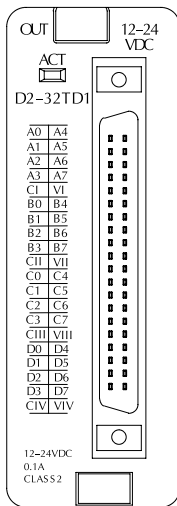
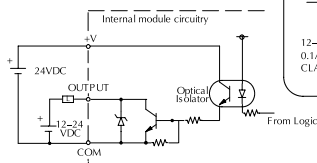
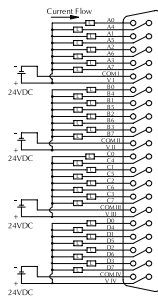
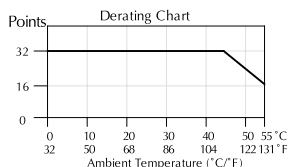

F2-08TA, AC Output

F2-08TA AC Output	
Outputs per Module	8
Commons per Module	2 (Isolated)
Output Type	SSR (Triac with zero crossover)
Operating Voltage	24–140 VAC
Peak Voltage	140VAC
ON Voltage Drop	1.6 V(rms) @ 1.5 A
AC Frequency	47 to 63 Hz
Minimum Load Current	50mA
Max Load Current	1.5 A / pt @ 30°C 1.0 A / pt @ 60°C 4.0 A / common; 8.0 A / module @ 60°C
Max Leakage Current	0.7 mA (rms)
Peak One Cycle Surge Current	15A
Base Power Required 5VDC	250mA
OFF to ON Response	0.5 ms - 1/2 cycle
ON to OFF Response	0.5 ms - 1/2 cycle
Terminal Type (included)	Removable; D2-8IOCON
Status Indicator	Logic side
Weight	3.5 oz. (100g)
Fuses	None

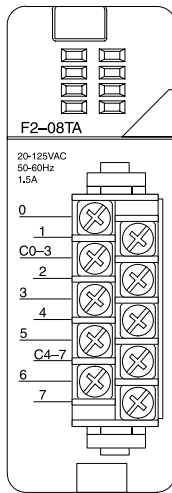
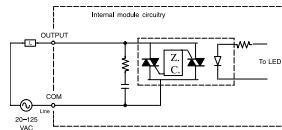
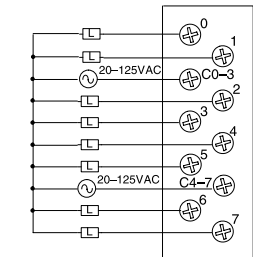
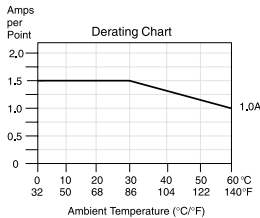

D2-08TA, AC Output

D2-08TA AC Output	
Outputs per Module	8
Commons per Module	1 (2 I/O terminal points)
Output Type	SSR (Triac)
Operating Voltage	15–264 VAC
Peak Voltage	264VAC
ON Voltage Drop	< 1.5 VAC (>0.1 A) < 3.0 VAC (<0.1 A)
AC Frequency	47 to 63Hz
Minimum Load Current	10mA
Max Load Current	0.5 A/point; 4A/common
Max Leakage Current	4mA (264VAC, 60Hz) 1.2 mA (100VAC, 60Hz) 0.9 mA (100VAC, 50Hz)
Max Inrush Current	10A for 10ms
Base Power Required 5VDC	250mA
OFF to ON Response	1 ms
ON to OFF Response	1 ms + 1/2 cycle
Terminal Type (included)	Removable; D2-8IOCON
Status Indicator	Logic side
Weight	2.8 oz. (80g)
Fuses	1 per common, 6.3 A slow blow, non-replaceable

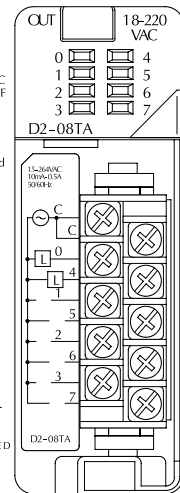
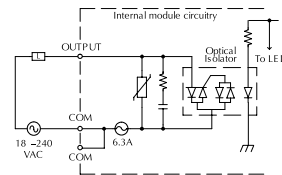
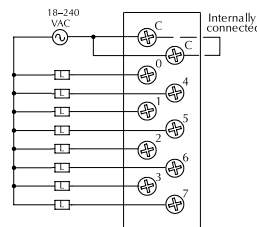
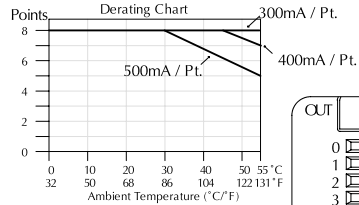

D2-12TA, AC Output

D2-12TA AC Output	
Outputs per Module	12
Outputs Points Consumed	16 (four unused, see chart below)
Commons per Module	2 (isolated)
Output Type	SSR (Triac)
Operating Voltage	15–132 VAC
Peak Voltage	132VAC
ON Voltage Drop	< 1.5 VAC (>50mA) < 4.0 VAC (<50mA)
AC Frequency	47 to 63 Hz
Minimum Load Current	10mA
Max Load Current	0.3 A/point; 1.8 A/common

Max Leakage Current	2mA (132VAC, 60Hz)
Max Inrush Current	10A for 10ms
Base Power Required 5VDC	350mA
OFF to ON Response	1ms
ON to OFF Response	1ms + 1/2 cycle
Terminal Type (included)	Removable; D2-16IOCON
Status Indicator	Logic side
Weight	2.8 oz. (80g)
Fuses	(2) 1 per common 3.15 A slow blow, replaceable Order D2-FUSE-1 (5 per pack)

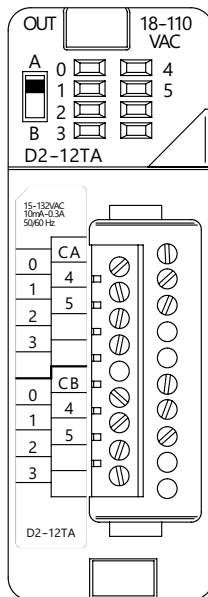
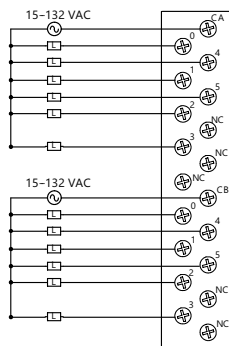
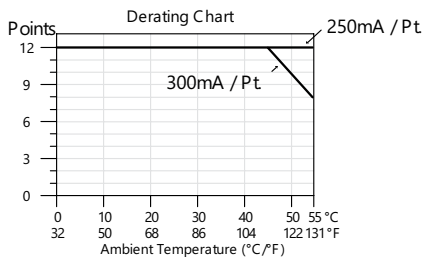

Addresses Used

Points	Used?	Points	Used?
Yn+0	Yes	Yn+10	Yes
Yn+1	Yes	Yn+11	Yes
Yn+2	Yes	Yn+12	Yes
Yn+3	Yes	Yn+13	Yes
Yn+4	Yes	Yn+14	Yes
Yn+5	Yes	Yn+15	Yes
Yn+6	No	Yn+16	No
Yn+7	No	Yn+17	No

n is the starting address

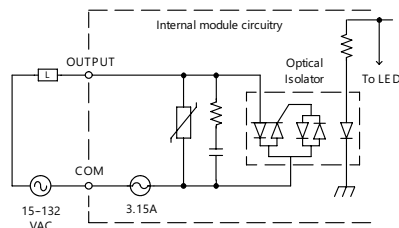

D2-04TRS, Relay Output

D2-04TRS Relay Output	
Outputs per Module	4
Outputs Points Consumed	8 (only 1st 4pts. are used)
Commons per Module	4 (isolated)
Output Type	Relay, form A (SPST)
Operating Voltage	5-30 VDC / 5-240 VAC
Peak Voltage	30 VDC, 264 VAC
ON Voltage Drop	0.72 VDC maximum
AC Frequency	47 to 63 Hz
Minimum Load Current	10mA
Max Load Current (resistive)	4A/point; 8A/module (resistive)

Max Leakage Current	0.1 mA @ 264VAC
Max Inrush Current	5A for < 10ms
Base Power Required 5VDC	250mA
OFF to ON Response	10ms
ON to OFF Response	10ms
Terminal Type (included)	Removable; D2-8IOCON
Status Indicator	Logic side
Weight	2.8 oz. (80g)
Fuses	1 per point 6.3 A slow blow, replaceable Order D2-FUSE-3 (5 per pack)

Typical Relay Life (Operations)	Voltage & Load Current			
	1A	2A	3A	4A
24VDC Resistive	500K	200K	100K	50K
24VDC Solenoid	100K	40K	—	—
110VAC Resistive	500K	250K	150K	100K
110VAC Solenoid	200K	100K	50K	—
220VAC Resistive	350K	150K	100K	50K
220VAC Solenoid	100K	50K	—	—

At 24VDC, solenoid (inductive) loads over 2A cannot be used.
 At 100VAC, solenoid (inductive) loads over 3A cannot be used.
 At 220VAC, solenoid (inductive) loads over 2A cannot be used.

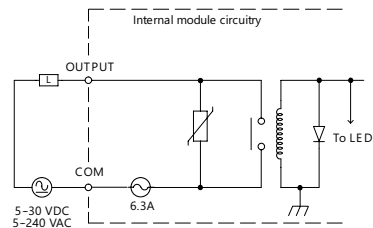
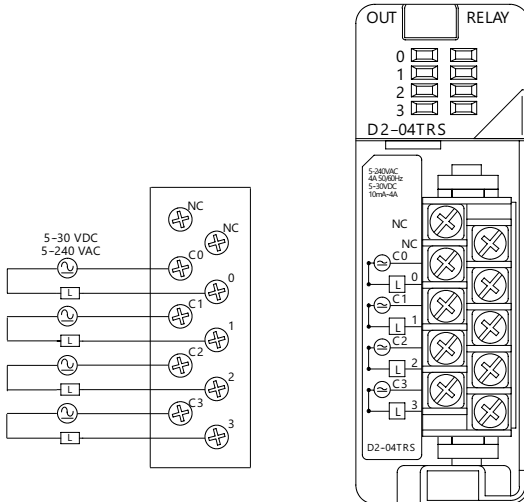
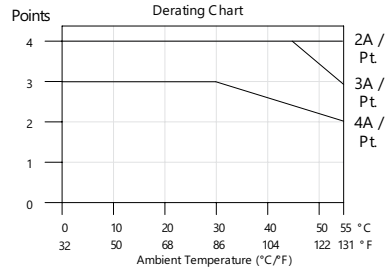

D2-08TR, Relay Output

D2-08TR Relay Output	
Outputs per Module	8
Outputs Points Consumed	8
Commons per Module	1 (2 I/O terminals)
Output Type	Relay, form A (SPST)
Operating Voltage	5–30 VDC; 5–240 VAC
Peak Voltage	30VDC, 264VAC
ON Voltage Drop	N/A
AC Frequency	47 to 60 Hz
Minimum Load Current	5mA @ 5VDC
Max Load Current (resistive)	1A/point; 4A/common

Max Leakage Current	0.1 mA @265 VAC
Max Inrush Current	Output: 3A for 10ms Common: 10A for 10ms
Base Power Required 5VDC	250mA
OFF to ON Response	12ms
ON to OFF Response	10ms
Terminal Type (included)	Removable; D2-8IOCON
Status Indicator	Logic side
Weight	3.9 oz. (110g)
Fuses	One 6.3A slow blow, replaceable Order D2-FUSE-3 (5 per pack)

Typical Relay Life (Operations)

Voltage/Load	Current	Closures
24VDC Resistive	1A	500K
24VDC Solenoid	1A	100K
110VAC Resistive	1A	500K
110VAC Solenoid	1A	200K
220VAC Resistive	1A	350K
220VAC Solenoid	1A	100K

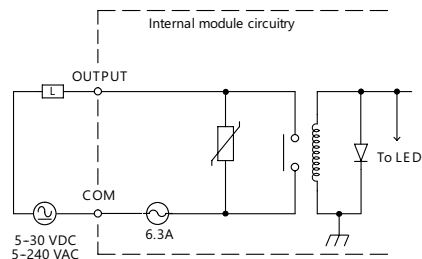
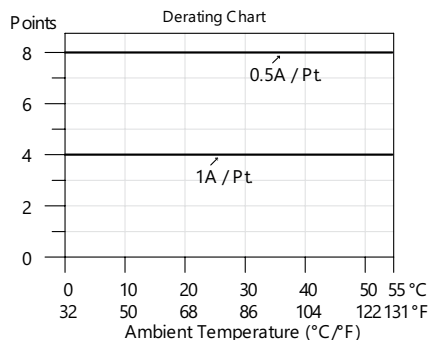
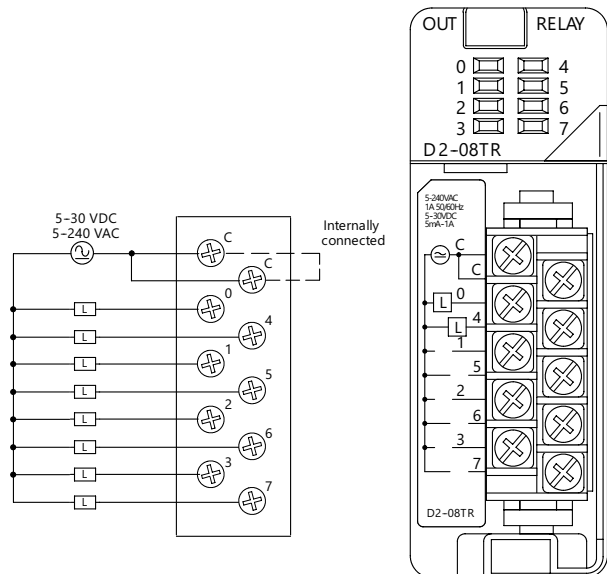

F2-08TR, Relay Output

F2-08TR Relay Output	
Outputs per Module	8
Outputs Points Consumed	8
Commons per Module	2 (isolated), 4-pts. per common
Output Type	8, Form A (SPST normally open)
Operating Voltage	7A @ 12-28 VDC, 12-250 VAC; 0.5 A @ 120VDC
Peak Voltage	150VDC, 265VAC
ON Voltage Drop	N/A
AC Frequency	47 to 63 Hz
Minimum Load Current	10 mA @ 12 VDC
Max Load Current (resistive)	10A/point 3 (subject to derating) Max of 10A/common
Max Leakage Current	N/A
Max Inrush Current	12A
Base Power Required 5VDC	670mA
OFF to ON Response	15ms (typical)
ON to OFF Response	5ms (typical)
Terminal Type (included)	Removable; D2-8IOCON
Status Indicator	Logic side
Weight	5.5 oz. (156g)
Fuses	None

Typical Relay Life (Operations) at Room Temperature			
Type of Load	Voltage & Load Current		
	50mA	5A	7A
24VDC Resistive	10M	600K	300K
24VDC Solenoid	-	150K	75K
110VAC Resistive	-	600K	300K
110VAC Solenoid	-	500K	200K
220VAC Resistive	-	300K	150K
220VAC Solenoid	-	250K	100K

1) Contact life may be extended beyond those values shown with the use of arc suppression techniques described in the DL205 User Manual. Since these modules have no leakage current, they do not have built-in snubber. For example, if you place a diode across a 24VDC inductive load, you can significantly increase the life of the relay.

2) At 120VDC 0.5 A resistive load, contact life cycle is 200K cycles.

3) Normally closed contacts have 1/2 the current handling capability of the normally open contacts.

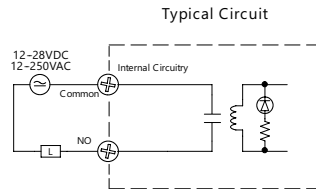
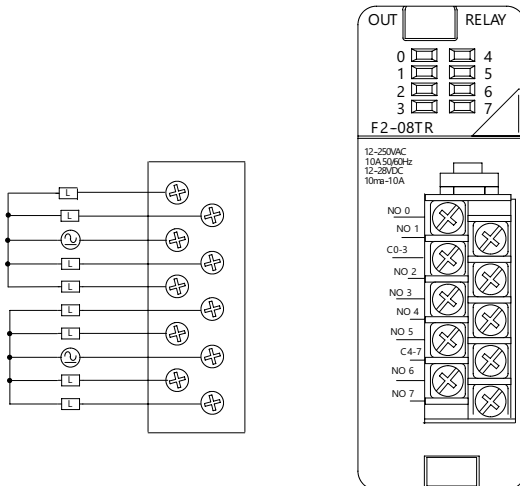
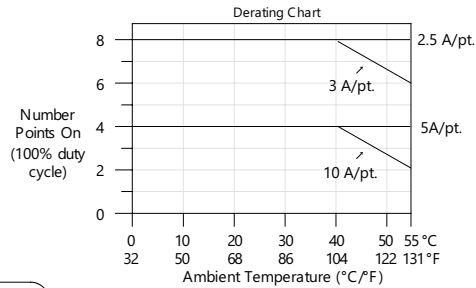

F2-08TRS, Relay Output

F2-08TRS Relay Output	
Outputs per Module	8
Outputs Points Consumed	8
Commons per Module	8 (isolated)
Output Type	3, Form C (SPDT) 5, Form A (SPST normally open)
Operating Voltage	7A @ 12–28 VDC, 12–250 VAC 0.5A @ 120VDC
Peak Voltage	150VDC, 265VAC
ON Voltage Drop	N/A
AC Frequency	47 to 63Hz
Minimum Load Current	10mA @ 12VDC
Max Load Current (resistive)	7A/point 3 (subject to derating)
Max Leakage Current	N/A
Max Inrush Current	12A
Base Power Required 5VDC	670mA
OFF to ON Response	15ms (typical)
ON to OFF Response	5ms (typical)
Terminal Type (included)	Removable; D2-16IOCON
Status Indicator	Logic side
Weight	5.5 oz. (156g)
Fuses	None

Typical Relay Life (Operations) at Room Temperature

Type of Load	Voltage & Load Current		
	50mA	5A	7A
24VDC Resistive	10M	600K	300K
24VDC Solenoid	–	150K	75K
110VAC Resistive	–	600K	300K
110VAC Solenoid	–	500K	200K
220VAC Resistive	–	300K	150K
220VAC Solenoid	–	250K	100K

1) Contact life may be extended beyond those values shown with the use of arc suppression techniques described in the DL205 User Manual. Since these modules have no leakage current, they do not have built-in snubber. For example, if you place a diode across a 24VDC inductive load, you can significantly increase the life of the relay.

2) At 120VDC 0.5 A resistive load, contact life cycle is 200K cycles.

3) Normally closed contacts have 1/2 the current handling capability of the normally open contacts.

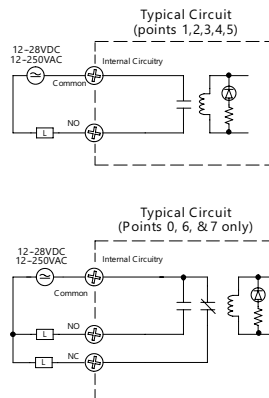
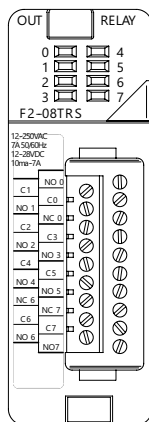
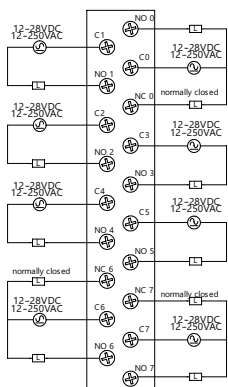
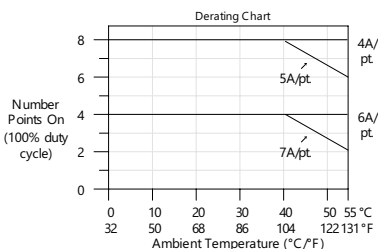

D2-12TR, Relay Output

D2-12TR Relay Output	
Outputs per Module	12
Outputs Points Consumed	16 (four unused, see chart below)
Commons per Module	2 (6-ptn. per common)
Output Type	Relay, form A (SPST)
Operating Voltage	5-30 VDC; 5-240 VAC
Peak Voltage	30VDC; 264VAC
ON Voltage Drop	N/A
AC Frequency	47 to 60 Hz
Minimum Load Current	5mA @ 5VDC
Max Load Current (resistive)	1.5 A/point; Max of 3A/ common
Max Leakage Current	0.1 mA @ 265VAC
Max Inrush Current	Output: 3A for 10ms Common: 10A for 10ms
Base Power Required 5VDC	450mA
OFF to ON Response	10ms
ON to OFF Response	10ms
Terminal Type (included)	Removable; D2-16IOCON
Status Indicator	Logic side
Weight	4.6 oz. (130g)
Fuses	(2) 4A slow blow, replaceable Order D2-FUSE-4 (5 per pack)

Typical Relay Life (Operations)		
Voltage/Load	Current	Closures
24VDC Resistive	1A	500K
24VDC Solenoid	1A	100K
110VAC Resistive	1A	500K
110VAC Solenoid	1A	200K
220VAC Resistive	1A	350K
220VAC Solenoid	1A	100K

Addresses Used			
Points*	Used?	Points*	Used?
Yn+0	Yes	Yn+10	Yes
Yn+1	Yes	Yn+11	Yes
Yn+2	Yes	Yn+12	Yes
Yn+3	Yes	Yn+13	Yes
Yn+4	Yes	Yn+14	Yes
Yn+5	Yes	Yn+15	Yes
Yn+6	No	Yn+16	No
Yn+7	No	Yn+17	No

* n is the starting address

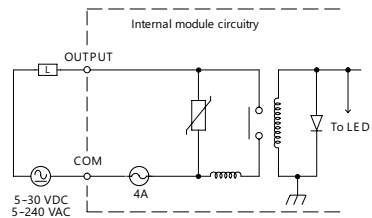
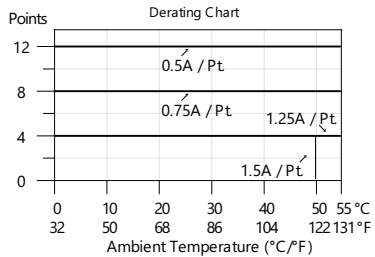
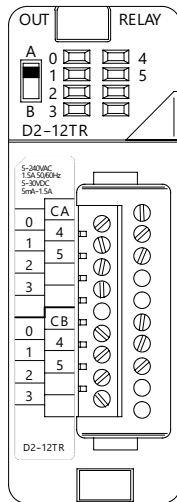
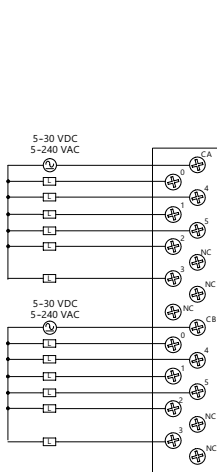

D2-08CDR, 4 pt. DC Input / 4 pt. Relay Output

D2-08CDR 4-pt. DC In / 4pt. Relay Out	
General Specifications	
Base Power Required 5VDC	200mA
Terminal Type (included)	Removable; D2-8IOCON
Status Indicator	Logic side
Weight	3.5 oz. (100 g)
Input Specifications	
Inputs per Module	4 (sink/source)
Input Points Consumed	8 (only first 4-pts. are used)
Commons per Module	1
Input Voltage Range	20–28 VDC
Peak Voltage	30VDC
ON Voltage Level	19VDC minimum
OFF Voltage Level	7VDC maximum
AC Frequency	N/A
Input Impedance	4.7 kΩ
Input Current	5mA @ 24VDC
Maximum Current	8mA @ 30VDC
Minimum ON Current	4.5 mA
Maximum OFF Current	1.5 mA
OFF to ON Response	1 to 10 ms
ON to OFF Response	1 to 10 ms
Fuses (input circuits)	None

Output Specifications	
Outputs per Module	4
Outputs Points Consumed	8 (only first 4-pts. are used)
Commons per Module	1
Output Type	Relay, form A (SPST)
Operating Voltage	5–30 VDC; 5–240 VAC
Peak Voltage	30VDC; 264VAC
ON Voltage Drop	N/A
AC Frequency	47 to 63 Hz
Minimum Load Current	5mA @ 5VDC
Max Load Current (resistive)	1A/point ; 4A/module
Max Leakage Current	0.1 mA @ 264VAC
Max Inrush Current	3A for < 100ms 10A for < 10ms (common)
OFF to ON Response	12ms
ON to OFF Response	10ms
Fuses (output circuits)	1 (6.3 A slow blow, replaceable); Order D2-FUSE-3 (5 per pack)

Typical Relay Life (Operations)		
Voltage/Load	Current	Closures
24VDC Resistive	1A	500K
24VDC Solenoid	1A	100K
110VAC Resistive	1A	500K
110VAC Solenoid	1A	200K
220VAC Resistive	1A	350K
220VAC Solenoid	1A	100K

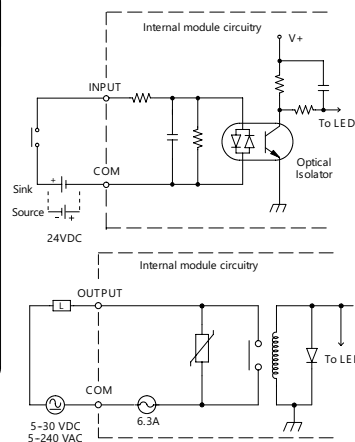
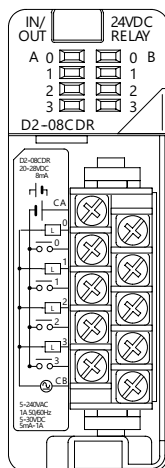
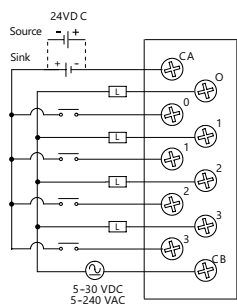
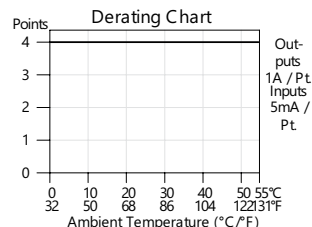

Glossary of Specification Terms

Inputs or Outputs Per Module

Indicates number of input or output points per module and designates current sinking, current sourcing, or either.

Commons Per Module

Number of commons per module and their electrical characteristics.

Input Voltage Range

The operating voltage range of the input circuit.

Output Voltage Range

The operating voltage range of the output circuit.

Peak Voltage

Maximum voltage allowed for the input circuit.

AC Frequency

AC modules are designed to operate within a specific frequency range.

ON Voltage Level

The voltage level at which the input point will turn ON.

OFF Voltage Level

The voltage level at which the input point will turn OFF.

Input impedance

Input impedance can be used to calculate input current for a particular operating voltage.

Input Current

Typical operating current for an active (ON) input.

Minimum ON Current

The minimum current for the input circuit to operate reliably in the ON state.

Maximum OFF Current

The maximum current for the input circuit to operate reliably in the OFF state.

Minimum Load

The minimum load current for the output circuit to operate properly.

External DC Required

Some output modules require external power for the output circuitry.

ON Voltage Drop

Sometimes called "saturation voltage," it is the voltage measured from an output point to its common terminal when the output is ON at maximum load.

Maximum Leakage Current

The maximum current a connected maximum load will receive when the output point is OFF.

Maximum Inrush Current

The maximum current used by a load for a short duration upon an OFF to ON transition of an output point. It is greater than the normal ON state current and is characteristic of inductive loads in AC circuits.

Base Power Required

Power from the base power supply is used by the DL205 input modules and varies between different modules. The guidelines for using module power are explained in the power budget configuration section in Chapter 4–7.

OFF to ON Response

The time the module requires to process an OFF to ON state transition.

ON to OFF Response

The time the module requires to process an ON to OFF state transition.

Terminal Type

Indicates whether the terminal type is a removable or non-removable connector or a terminal.

Status Indicators

The LEDs that indicate the ON/OFF status of an input point. These LEDs are electrically located on either the logic side or the field device side of the input circuit.

Weight

Indicates the weight of the module. See Appendix F for a list of the weights for the various DL205 components.

Fuses

Protective devices for an output circuit, which stop current flow when current exceeds the fuse rating. They may be replaceable or non-replaceable, or located externally or internally.