

# MAINTENANCE AND TROUBLESHOOTING

---



# CHAPTER 9

## In This Chapter...

Hardware System Maintenance .....	9-2
Diagnostics.....	9-2
CPU Indicators .....	9-6
Communications Problems .....	9-7
I/O Point Troubleshooting .....	9-8
Noise Troubleshooting .....	9-10
Machine Startup and Program Troubleshooting .....	9-11

# Hardware System Maintenance

## Standard Maintenance

No regular or preventative maintenance is required for this product (there are no internal batteries); however, a routine maintenance check (about every one or two months) of your PLC and control system is good practice, and should include the following items:

- Air Temperature – Monitor the air temperature in the control cabinet, so the operating temperature range of any component is not exceeded.
- Air Filter – If the control cabinet has an air filter, clean or replace it periodically as required.
- Fuses or breakers – Verify that all fuses and breakers are intact.
- Cleaning the Unit – Check that all air vents are clear. If the exterior case needs cleaning, disconnect the input power, and carefully wipe the case using a damp cloth. Do not let water enter the case through the air vents and do not use strong detergents because this may discolor the case.

## Diagnostics

### Diagnostics

Your DL06 Micro PLC performs many pre-defined diagnostic routines with every CPU scan. The diagnostics can detect various errors or failures in the PLC. The two primary error classes are *fatal* and *non-fatal*.

### Fatal Errors

Fatal errors are errors which may cause the system to function improperly, perhaps introducing a safety problem. The CPU will automatically switch to Program Mode if it is in Run Mode. (Remember, in Program Mode all outputs are turned off.) If the fatal error is detected while the CPU is in Program Mode, the CPU will not allow you to transition to Run Mode until the error has been corrected.

Some examples of fatal errors are:

- Power supply failure
- Parity error or CPU malfunction
- Particular programming errors

### Non-fatal Errors

Non-fatal errors are errors that need your attention, but should not cause improper operation. They do not cause or prevent any mode transitions of the CPU. The application program can use special relay contacts to detect non-fatal errors, and even take the system to an orderly shutdown or switch the CPU to Program Mode if desired. An example of a non-fatal error is:

- Particular programming errors - The programming devices will notify you of an error if one occurs while online.
- *DirectSOFT* provides the error number and an error message.
- The handheld programmer displays error numbers and short descriptions of the error.

Appendix B has a complete list of error messages in order by error number. Many error messages point to supplemental V-memory locations which contain related information. Special relays (SP contacts) also provide error indications (refer to Appendix D).

### V-memory Error Code Locations

The following table names the specific memory locations that correspond to certain types of error messages.

Error Class	Error Category	Diagnostic V-memory
User-Defined	Error code used with FAULT instruction	V7751
System Error	Fatal Error code	V7755
	Major Error code	V7756
	Minor Error code	V7757
Grammatical	Address where syntax error occurs	V7763
	Error Code found during syntax check	V7764
CPU Scan	Number of scans since last Program to Run Mode transition	V7765
	Current scan time (ms)	V7775
	Minimum scan time (ms)	V7776
	Maximum scan time (ms)	V7777

### Special Relays (SP) Corresponding to Error Codes

The special relay table also includes status indicators which can indicate errors. For a more detailed description of each of these special relays refer to Appendix D.

CPU Status Relays	
SP11	Forced Run mode
SP12	Terminal Run mode
SP13	Test Run mode
SP15	Test stop mode
SP16	Terminal Program mode
SP17	Forced stop
SP20	STOP instruction was executed
SP22	Interrupt enabled
System Monitoring Relays	
SP36	Override setup
SP37	Scan control error
SP40	Critical error
SP41	Non-critical error
SP42	Diagnostics error
SP44	Program memory error
SP45	I/O error
SP46	Communications error
SP50	Fault instruction was executed
SP51	Watchdog timeout
SP52	Syntax error
SP53	Cannot solve the logic
SP54	Communication error
SP56	Table instruction overrun

Accumulator Status Relays	
SP60	Acc. is less than value
SP61	Acc. is equal to value
SP62	Acc. is greater than value
SP63	Acc. result is zero
SP64	Half borrow occurred
SP65	Borrow occurred
SP66	Half carry occurred
SP67	Carry occurred
SP70	Result is negative (sign)
SP71	Pointer reference error
SP73	Overflow
SP75	Data is not in BCD
SP76	Load zero

### DL06 Micro PLC Error Codes

These errors can be generated by the CPU or by the Handheld Programmer, depending on the actual error. Appendix B provides a more complete description of the error codes.

The errors can be detected at various times. However, most of them are detected at power-up, on entry to Run Mode, or when a Handheld Programmer key sequence results in an error or an illegal request.

Error Code	Description	Error Code	Description
E003	Software time-out	E526	Unit is offline
E004	Invalid instruction(RAM parity error in the CPU)	E527	Unit is online
E104	Write failed	E528	CPU mode
E151	Invalid command	E540	CPU locked
E311	Communications error 1	E541	Wrong password
E312	Communications error 2	E542	Password reset
E313	Communications error 3	E601	Memory full
E316	Communications error 6	E602	Instruction missing
E320	Time out	E604	Reference missing
E321	Communications error	E620	Out of memory
E360	HP Peripheral port time-out	E621	EEPROM Memory not blank
E501	Bad entry	E622	No Handheld Programmer EEPROM
E502	Bad address	E624	V memory only
E503	Bad command	E625	Program only
E504	Bad reference / value	E627	Bad write operation
E505	Invalid instruction	E628	Memory type error (should be EEPROM)
E506	Invalid operation	E640	Mis-compare
E520	Bad operation – CPU in Run	E650	Handheld Programmer system error
E521	Bad operation – CPU in Test Run	E651	Handheld Programmer ROM error
E523	Bad operation – CPU in Test Program	E652	Handheld Programmer RAM error
E524	Bad operation – CPU in Program		
E525	Mode Switch not in Term position		

## Program Error Codes

The following table lists program syntax and runtime error codes. Error detection occurs during a Program-to-Run mode transition, or when you use AUX 21 – Check Program. The CPU will also turn on SP52 and store the error code in V7755. Appendix B provides a more complete description of the error codes.

Error Code	Description
E4**	No Program in CPU
E401	Missing END statement
E402	Missing LBL
E403	Missing RET
E404	Missing FOR
E405	Missing NEXT
E406	Missing IRT
E412	SBR / LBL >64
E421	Duplicate Stage reference
E422	Duplicate SBR/LBL reference
E423	Nested Loop
E431	Invalid ISG/SG address
E433	Invalid ISG / SG address
E434	Invalid RTC
E435	Invalid RT
E436	Invalid INT address
E437	Invalid IRTC

Error Code	Description
E438	Invalid IRT address
E440	Invalid Data Address
E441	ACON/NCON
E451	Bad MLS/MLR
E453	Missing T/C
E454	Bad TMRA
E455	Bad CNT
E456	Bad SR
E461	Stack Overflow
E462	Stack Underflow
E463	Logic Error
E464	Missing Circuit
E471	Duplicate Coil reference
E472	Duplicate TMR reference
E473	Duplicate CNT reference
E499	Print Instruction

### CPU Indicators

The DL06 Micro PLCs have indicators on the front to help you determine potential problems with the system. In normal runtime operation only, the RUN and PWR indicators are on. The table below is a quick reference to potential problems.

Indicator Status	Potential Problems
PWR (Green LED off)	System voltage incorrect PLC power supply faulty
RUN (Green LED off)	CPU programming error CPU in program mode
RUN (Green LED flashing)	CPU in firmware upgrade mode
CPU (Red LED on)	Electrical noise interference Internal CPU defective
CPU (Blinking Red LED)	Low backup battery (refer to page 3-8)

#### PWR Indicator

In general there are three reasons for the CPU power status LED (PWR) to be OFF:

1. Power to the unit is incorrect or is not applied.
2. PLC power supply is faulty.
3. Other component(s) have the power supply shut down.

If the voltage to the power supply is not correct, the PLC may not operate properly or may not operate at all. Use the following guidelines to correct the problem.



**WARNING: To minimize the risk of electrical shock, always disconnect the system power before inspecting the physical wiring.**

---

1. First, disconnect the external power.
2. Verify that all external circuit breakers or fuses are still intact.
3. Check all incoming wiring for loose connections. If you're using a separate termination block, check those connections for accuracy and integrity.
4. If the connections are acceptable, reconnect the system power and verify the voltage at the DL06 power input is within specification. If the voltage is not correct, shut down the system and correct the problem.
5. If all wiring is connected correctly and the incoming power is within the specifications, the PLC internal supply may be faulty.

The best way to check for a faulty PLC is to substitute a known good one to see if this corrects the problem. The removable connectors on the DL06 make this relatively easy. If there has been a major power surge, it is possible the PLC internal power supply has been damaged. If you suspect this is the cause of the power supply damage, consider installing an AC line conditioner to attenuate damaging voltage spikes in the future.

### RUN Indicator

If the CPU will not enter the Run mode (the RUN indicator is off), the problem is usually in the application program, unless the CPU has a fatal error. If a fatal error has occurred, the CPU LED should be on. (You can use a programming device to determine the cause of the error.)

Both of the programming devices, Handheld Programmer and *DirectSOFT*, will return an error message describing the problem. Depending on the error, there may also be an AUX function you can use to help diagnose the problem. The most common programming error is “Missing END Statement”. All application programs require an END statement for proper termination. A complete list of error codes can be found in Appendix B.

The RUN indicator will flash (blink) whenever the CPU is in the firmware upgrade mode.

### CPU Indicator

If the CPU indicator is on, a fatal error has occurred in the CPU. Generally, this is not a programming problem but an actual hardware failure. You can power cycle the system to clear the error. If the error clears, you should monitor the system and determine what caused the problem. You will find this problem is sometimes caused by high frequency electrical noise introduced into the CPU from an outside source. Check your system grounding and install electrical noise filters if the grounding is suspected. If power cycling the system does not reset the error, or if the problem returns, you should replace the CPU.

If the CPU indicator is blinking, the backup battery is low (refer to page 3-8).

## Communications Problems

If you cannot establish communications with the CPU, check these items.

- The cable is disconnected.
- The cable has a broken wire or has been wired incorrectly.
- The cable is improperly terminated or grounded.
- The device connected is not operating at the correct baud rate (9600 baud).
- The device connected to the port is sending data incorrectly, or another application is running on the device.
- A grounding difference exists between the two devices.
- Electrical noise is causing intermittent errors.
- The PLC has a bad communication port and should be replaced.

For problems in communicating with *DirectSOFT* on a personal computer, refer to the *DirectSOFT* programming user manual. It includes a troubleshooting section that can help you diagnose PC problems in communications port setup, address or interrupt conflicts, etc.

# I/O Point Troubleshooting

## Possible Causes

If you suspect an I/O error, there are several things that could be causing the problem.

- High-Speed I/O configuration error
- A blown fuse in your machine or panel (the DL06 does not have internal I/O fuses)
- A loose terminal block
- The auxiliary 24 VDC supply has failed
- The Input or Output Circuit has failed

## Some Quick Steps

When troubleshooting the DL06 Micro PLCs, please be aware of the following facts which may assist you in quickly correcting an I/O problem.

- HSIO configuration errors are commonly mistaken for I/O point failure during program development. If the I/O point in question is in X0–X2, or Y0–Y1, check all parameter locations listed in Chapter 3 that apply to the HSIO mode you have selected.
- The output circuits cannot detect shorted or open output points. If you suspect one or more faulty points, measure the voltage drop from the common to the suspect point. Remember when using a Digital Volt Meter, leakage current from an output device such as a triac or a transistor must be considered. A point which is off may appear to be on if no load is connected the point.
- The I/O point status indicators are logic-side indicators. This means the LED which indicates the on or off status reflects the status of the point with respect to the CPU. On an output point the status indicators could be operating normally while the actual output device (transistor, triac etc.) could be damaged. With an input point, if the indicator LED is on, the input circuitry is probably operating properly. Verify the LED goes off when the input signal is removed.
- Leakage current can be a problem when connecting field devices to an I/O point. False input signals can be generated when the leakage current of an output device is great enough to turn on the connected input device. To correct this install a resistor in parallel with the input or output of the circuit. The value of this resistor will depend on the amount of leakage current and the voltage applied but usually a 10K to 20K resistor will work. Verify the wattage rating of the resistor is correct for your application.
- Because of the removable terminal blocks on the DL06, the easiest method to determine if an I/O circuit has failed is to replace the unit if you have a spare. However, if you suspect a field device is defective, that device may cause the same failure in the replacement PLC as well. As a point of caution, you may want to check devices or power supplies connected to the failed I/O circuit before replacing the unit with a spare.



Output points can be set on or off in the DL06 series CPUs. If you want to do an I/O check-out independent of the application program, follow the procedure below:

Step	Action
1	Use a handheld programmer or <i>DirectSOFT</i> to communicate online to the PLC.
2	Change to Program Mode.
3	Go to address 0.
4	Insert an "END" statement at address 0. (This will cause program execution to occur only at address 0 and prevent the application program from turning the I/O points on or off).
5	Change to Run Mode.
6	Use the programming device to set (turn) on or off the points you wish to test.
7	When you finish testing I/O points delete the "END" statement at address 0.



**WARNING:** Depending on your application, forcing I/O points may cause unpredictable machine operation that can result in a risk of personal injury or equipment damage. Make sure you have taken all appropriate safety precautions prior to testing any I/O points.

### Handheld Programmer Keystrokes Used to Test an Output Point

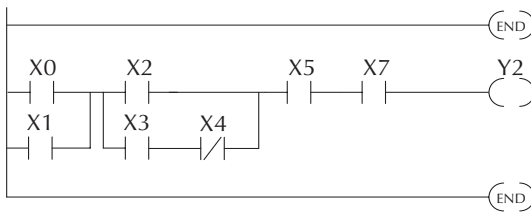

Insert an END statement at the beginning of the program. This disables the remainder of the program.

From a clear display, use the following keystrokes



Use the PREV or NEXT keys to select the Y data type

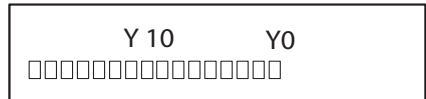

Use arrow keys to select point, then use ON and OFF to change the status

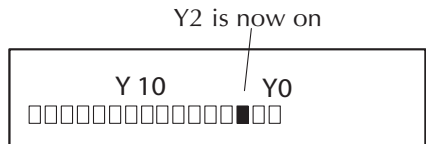

# Noise Troubleshooting

## Electrical Noise Problems

Noise is one of the most difficult problems to diagnose. Electrical noise can enter a system in many different ways and falls into one of two categories, conducted or radiated. It may be difficult to determine how the noise is entering the system but the corrective actions for either of the types of noise problems are similar.

- Conducted noise is when the electrical interference is introduced into the system by way of an attached wire, panel connection ,etc. It may enter through an I/O circuit, a power supply connection, the communication ground connection, or the chassis ground connection.
- Radiated noise is when the electrical interference is introduced into the system without a direct electrical connection, much in the same manner as radio waves.

## Reducing Electrical Noise

While electrical noise cannot be eliminated it can be reduced to a level that will not affect the system.

- Most noise problems result from improper grounding of the system. A good earth ground can be the single most effective way to correct noise problems. If a ground is not available, install a ground rod as close to the system as possible. Ensure all ground wires are single point grounds and are not daisy chained from one device to another. Ground metal enclosures around the system. A loose wire can act as a large antenna, introducing noise into the system, so, tighten all connections in your system. Loose ground wires are more susceptible to noise than the other wires in your system. Review Chapter 2 Installation, Wiring, and Specifications if you have questions regarding how to ground your system.
- Electrical noise can enter the system through the power source for the PLC and I/O circuits. Installing an isolation transformer for all AC sources can correct this problem. DC sources should be well-grounded good quality supplies.
- Separate input wiring from output wiring. Never run low-voltage I/O wiring close to high voltage wiring.

## Machine Startup and Program Troubleshooting

The DL06 Micro PLCs provide several features that can help you debug your program before and during machine startup. This section discusses the following topics which can be very helpful.

- Program Syntax Check
- Duplicate Reference Check
- Special Instructions
- Run Time Edits
- Forcing I/O Points

### Syntax Check

Even though the Handheld Programmer and *Direct*SOFT provide error checking during program entry, you may want to check a program that has been modified. Both programming devices offer a way to check the program syntax. For example, you can use AUX 21, CHECK PROGRAM to check the program syntax from a Handheld Programmer, or you can use the PLC Diagnostics menu option within *Direct*SOFT. This check will find a wide variety of programming errors. The following example shows how to use the syntax check with a Handheld Programmer.

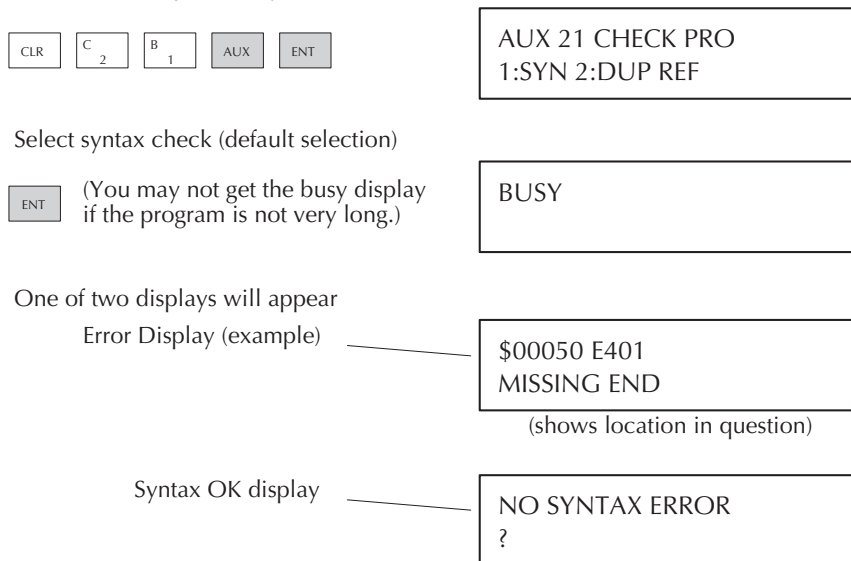

See the Error Codes Section for a complete listing of programming error codes. If you get an error, just press CLR and the Handheld will display the instruction where the error occurred. Correct the problem and continue running the Syntax check until the NO SYNTAX ERROR message appears.

### Special Instructions

There are several instructions that can be used to help you debug your program during machine startup operations.

- END
- PAUSE
- STOP

**END Instruction:** If you need a way to quickly disable part of the program, just insert an END statement prior to the portion that should be disabled. When the CPU encounters the END statement, it assumes that is the end of the program. The following diagram shows an example.

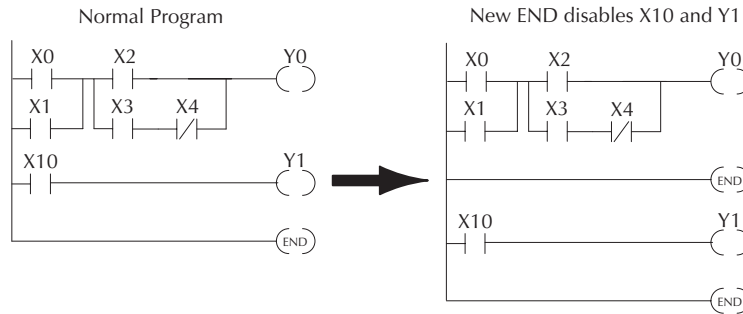

**PAUSE Instruction:** This instruction provides a quick way to allow the inputs (or other logic) to operate while disabling selected outputs. The output image register is still updated, but the output circuits are not. For example, you could make this conditional by adding an input contact or CR to control the instruction with a switch or a programming device. Or, you could just add the instruction without any conditions so the selected outputs would be disabled at all times.

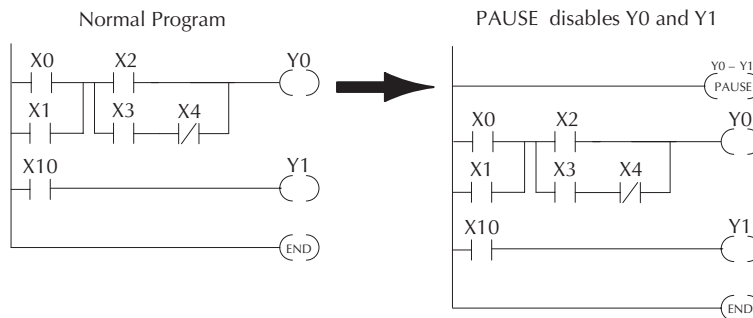

**STOP Instruction:** Sometimes during machine startup you need a way to quickly turn off all the outputs and return to Program Mode. You can use the STOP instruction. When this instruction is executed the CPU automatically exits Run Mode and enters Program Mode. Remember, all outputs are turned off during Program Mode. The following diagram shows an example of a condition that returns the CPU to Program Mode.

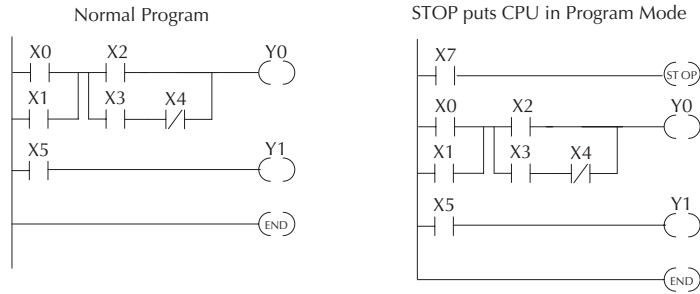

In the example shown above, you could trigger X7 which would execute the STOP instruction. The CPU would enter Program Mode and all outputs would be turned off.

### Duplicate Reference Check

You can also check for multiple uses of the same output coil. Both programming devices offer a way to check for this condition. For example, you can use AUX 21, CHECK PROGRAM to check for duplicate references from a Handheld Programmer, or you can use the PLC Diagnostics menu option within *DirectSOFT*. The following example shows how to perform the duplicate reference check with a Handheld Programmer.

If you get an error, just press CLR and the Handheld will display the instruction where the error occurred. Correct the problem and continue running the Duplicate Reference check until no duplicate references are found.

Use AUX 21 to perform syntax check

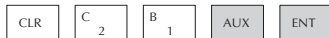

AUX 21 CHECK PRO  
1:SYN 2:DUP REF

Select duplicate reference check

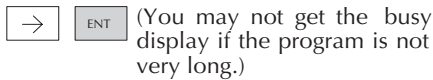

BUSY

One of two displays will appear

Error Display (example)  
(shows location in question)

\$00024 E471  
DUP COIL REF

Syntax OK display

NO DUP REFS  
?



**NOTE:** You can use the same coil in more than one location, especially in programs containing Stage instructions and / or OROUT instructions. The Duplicate Reference check will find occurrences, even though they are acceptable.

### Run Time Edits

The DL06 Micro PLC allows you to make changes to the application program during Run Mode. These edits are not “bumpless.” Instead, CPU scan is momentarily interrupted (and the outputs are maintained in their current state) until the program change is complete. This means if the output is off, it will remain off until the program change is complete. If the output is on, it will remain on.



**WARNING:** Only authorized personnel fully familiar with all aspects of the application should make changes to the program. Changes during Run Mode become effective immediately. Make sure you thoroughly consider the impact of any changes to minimize the risk of personal injury or damage to equipment. There are some important operational changes during Run Time Edits.

1. If there is a syntax error in the new instruction, the CPU will not enter the Run Mode.
2. If you delete an output coil reference and the output was on at the time, the output will remain on until it is forced off with a programming device.
3. Input point changes are not acknowledged during Run Time Edits, so, if you're using a high-speed operation and a critical input comes on, the CPU may not see the change.

Not all instructions can be edited during a Run Time Edit session. The following list shows the instructions that can be edited.

Mnemonic	Description
TMR	Timer
TMRF	Fast timer
TMRA	Accumulating timer
TMRAF	Accumulating fast timer
CNT	Counter
UDC	Up / Down counter
SGCNT	Stage counter
STR, STRN	Store, Store not (Boolean)
AND, ANDN	And, And not (Boolean)
OR, ORN	Or, Or not (Boolean)
STRE, STRNE	Store equal, Store not equal
ANDE, ANDNE	And equal, And not equal
ORE, ORNE	Or equal, Or not equal
STR, STRN	Store greater than or equal Store less than (Comparative Boolean)
AND, ANDN	And greater than or equal And less than (Comparative Boolean)

Mnemonic	Description
OR, ORN	Or greater than or equal or less than (Comparative Boolean)
LD	Load data (constant)
LDD	Load data double (constant)
ADD	Add data double (constant)
SUBD	Subtract data double (constant)
MUL	Multiply (constant)
DIV	Divide (constant)
CMPD	Compare accumulator (constant)
ANDD	And accumulator (constant)
ORD	Or accumulator (constant)
XORD	Exclusive or accumulator (constant)
LD	Load discrete points to accumulator
OUTF	Output accumulator to discrete points
SHFR	Shift accumulator right
SHFL	Shift accumulator left
NCON	Numeric constant

### Run Time Edit Example

We'll use the program logic shown to describe how this process works. In the example, we'll change X0 to C10. Note, the example assumes you have already placed the CPU in Run Mode.

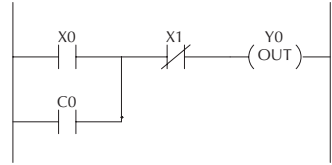

Use the **MODE** key to select Run Time Edits



\*MODE CHANGE\*  
RUN TIME EDIT?

Press **ENT** to confirm the Run Time Edits



\*MODE CHANGE\*  
RUNTIME EDITS

Find the instruction you want to change (**X0**)

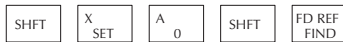

\$00000 STR X0

Press the arrow key to move to the **X**. Then enter the new contact (**C10**).

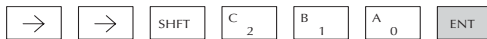

RUNTIME EDIT?  
STR C10

Press **ENT** to confirm the change.

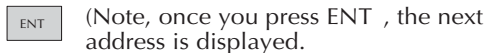

OR C0

### Forcing I/O Points

There are many times, especially during machine startup and troubleshooting, that you need the capability to force an I/O point to be either on or off. Before you use a programming device to force any data type, it is important to understand how the DL06 CPUs process the forcing requests.



---

**WARNING: Only authorized personnel fully familiar with all aspects of the application should make changes to the program. Make sure you thoroughly consider the impact of any changes to minimize the risk of personal injury or damage to equipment.**

---

There are two types of forcing available with the DL06 CPUs. (Chapter 3 provides a detailed description of how the CPU processes each type of forcing request).

**Regular Forcing:** This type of forcing can temporarily change the status of a discrete bit. For example, you may want to force an input on, even though it is really off. This allows you to change the point status that was stored in the image register. This value will be valid until the image register location is written to during the next scan. This is primarily useful during testing situations when you need to force a bit on to trigger another event.

**Bit Override:** Bit override can be enabled on a point-by-point basis by using AUX 59 from the Handheld Programmer or by a menu option in *DirectSOFT*. You can use Bit Override with X, Y, C, T, CT, and S data types. Bit override basically disables any changes to the discrete point by the CPU. For example, if you enable bit override for X1, and X1 is off at the time, the CPU will not change the state of X1. This means that even if X1 comes on, the CPU will not acknowledge the change. Therefore, if you used X1 in the program, it would always be evaluated as **off**, in this case. If X1 was on when the bit override was enabled, then X1 would always be evaluated as **on**.

There is an advantage available when you use the Bit Override feature. The Regular Forcing is not disabled because the Bit Override is enabled. For example, if you enabled the Bit Override for Y0 and it was off at the time, the CPU would not change the state of Y0. However, you can still use a programming device to change the status. If you use the programming device to force Y0 on, it will remain on and the CPU will not change the state of Y0. If you then force Y0 off, the CPU will maintain Y0 as off. The CPU will never update the point with the results from the application program or from the I/O update until the Bit Override is removed from the point.



The following diagrams show how the bit override works for both input and output points. The example uses a simple rung, but the concepts are similar for any type of bit memory.

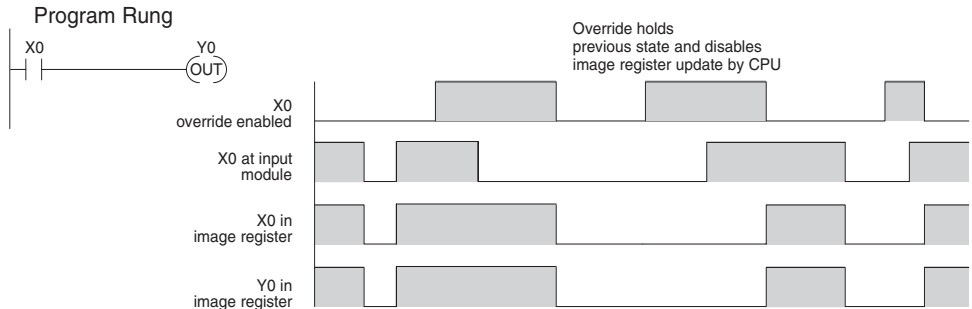

The following diagram shows how the bit override works for an output point. Notice the bit override maintains the output in the current state. If the output is on when the bit override is enabled, then the output stays on. If it is off, then the output stays off.

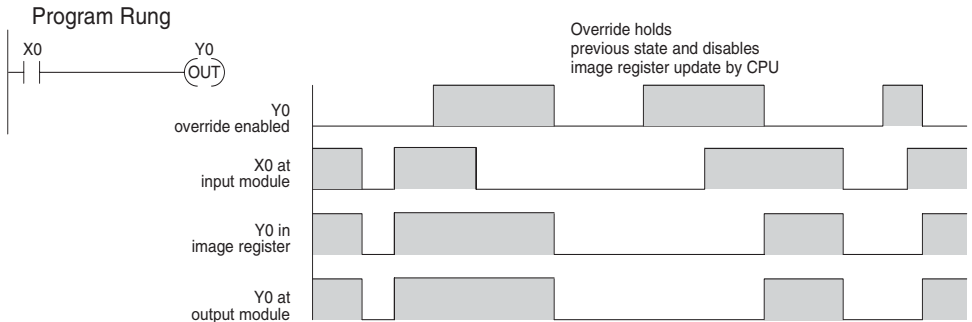

The following diagram shows how you can use a programming device in combination with the bit override to change the status of the point. Remember, bit override only disables CPU changes. You can still use a programming device to force the status of the point. Plus, since bit override maintains the current status, this enables true forcing. The example shown is for an output point, but you can also use the other bit data types.

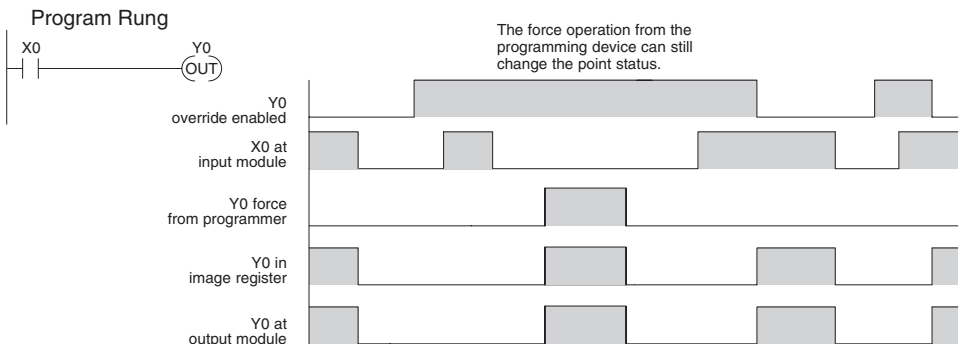

## Chapter 9: Maintenance and Troubleshooting

The following diagrams show a brief example of how you could use the DL06 Handheld Programmer to force an I/O point. Remember, if you are using the Bit Override feature, the CPU will retain the forced value until you disable the Bit Override or until you remove the force. The image register will not be updated with the status from the input module. Also, the solution from the application program will not be used to update the output image register. The example assumes you have already placed the CPU into Run Mode.

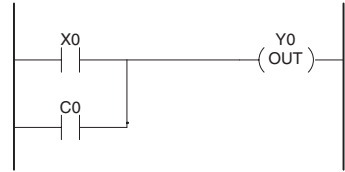

From a clear display, use the following keystrokes

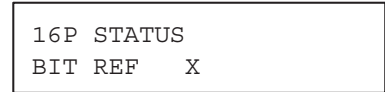

Use the PREV or NEXT keys to select the Y data type. Once the Y appears, press 0 to start at Y0.

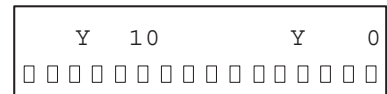
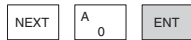

Use arrow keys to select point, then use ON and OFF to change the status

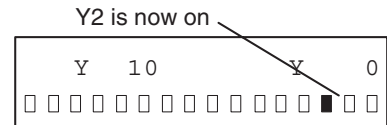

### Regular Forcing with Direct Access

From a clear display, use the following keystrokes to force Y10 ON. Solid fill indicates point is on.

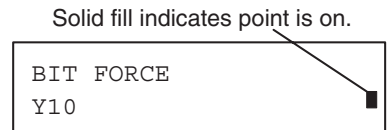

From a clear display, use the following keystrokes to force Y10 OFF. No fill indicates point is off.

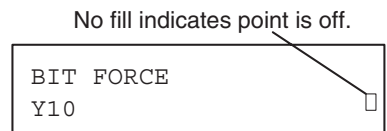

### Bit Override Forcing

From a clear display, use the following keystrokes to turn on the override bit for Y10.

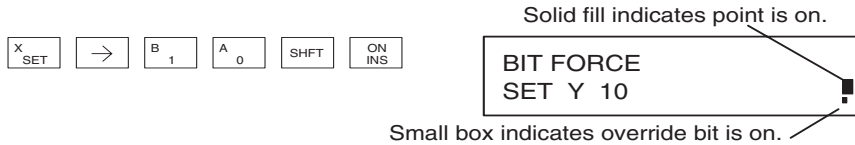

Note, at this point you can use the PREV and NEXT keys to move to adjacent memory locations and use the SHFT ON keys to set the override bit on.

From a clear display, use the following keystrokes to turn off the override bit for Y10. Solid fill indicates point is on.

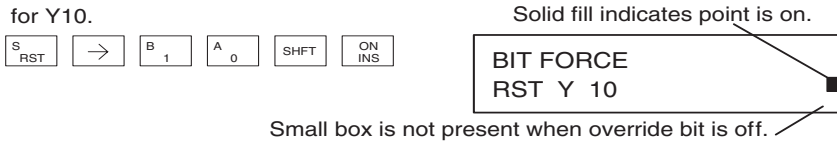

Like the example above, you can use the PREV and NEXT keys to move to adjacent memory locations and use the SHFT OFF keys to set the override bit off.

### Bit Override Indicators

Override bit indicators are also shown on the handheld programmer status display. Below are the keystrokes to call the status display for Y10 – Y20.

From a clear display, use the following keystrokes to display the status of Y10 – Y20.

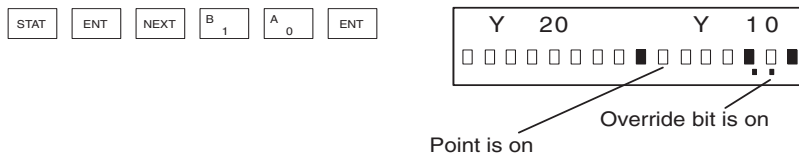

### Reset the PLC to Factory Defaults



---

**NOTE:** Resetting to factory defaults will not clear any password stored in the PLC.

---

Resetting a DirectLogic PLC to Factory Defaults is a two-step process. Be sure to have a verified backup of your program using “Save Project to Disk” from the File menu before performing this procedure. Please be aware that the program as well as any settings will be erased and not all settings are stored in the project. In particular you will need to write down any settings for Secondary Communications Ports and manually set the ports up after resetting the PLC to factory defaults.

Step One – While connected to the PLC with DirectSoft, go to the PLC menu and select; “Clear PLC Memory”. Check the “ALL” box at the bottom of the list and press “OK”.

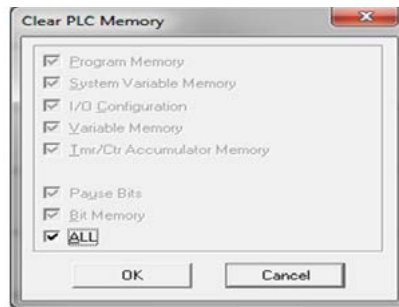

Step Two – While connected with DirectSoft, go the PLC menu and then to the “Setup” submenu and select; “Initialize Scratch Pad” and press “Ok”.



---

**NOTE:** All configurable communications ports will be reset to factory default state. If you are connected via Port 2 or another configurable port, you may be disconnected when this operation is complete.

---

---

**NOTE:** Retentive ranges will be reset to the factory settings..

---

---

**NOTE:** Manually addressed IO will be reset to factory default settings..

---

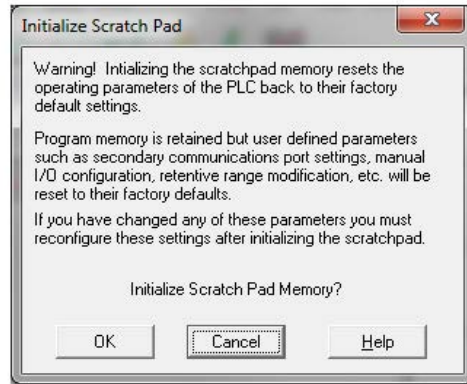

The PLC has now been reset to factory defaults and you can proceed to program the PLC.