



---

## In This Chapter...

Common Problems.....	8-2
Troubleshooting Flow Chart.....	8-3
HMI Does Not Power Up .....	8-4
<i>C-more</i> LED Status Indicators .....	8-5
General Errors and Warnings.....	8-6
CM5-RHMI Beep.....	8-6
Display is Blank.....	8-7
No User Program .....	8-8
Touch Screen Does Not Work.....	8-9
Select Touch Panel Driver .....	8-10
Safe Mode Recovery .....	8-14
Safe Mode (ERR-202-5) .....	8-15
USB Driver Troubleshooting.....	8-16
No Communications between Panel and PC (Personal Computer) .....	8-17
No Communications Between Panel and PC (Personal Computer) via USB .....	8-23
No Communications Between Panel and PC (Personal Computer) via Ethernet .....	8-25
No Communications between Panel and PLC .....	8-26
IP Address in System Setup Screens Displays 0.0.0.0.....	8-30
Difficulty Connecting to the Panel over the Internet (Web Server and Remote Access Features) .....	8-31
PLC Protocol Error Codes .....	8-32
HMI Runtime Errors.....	8-33
Panel Constantly Displays “Initializing” when Powering Up .....	8-34
Data Not Logging Problems.....	8-34
Electrical Noise Problems.....	8-35
Touch Screen Not Working .....	8-35



The following topics are some of the more likely problems that may be encountered during the installation and operation of your **C-more** HMI. We have made some suggestions on what to check in order to correct the problem. Please start with the troubleshooting flow chart that covers the more common problems encountered by other users.

## Common Problems

The troubleshooting flow chart shown on the following page is based on the more common problems fielded by our technical support team. Then, if you are having problems, please start with the flow chart and follow the suggestions listed. and if you still need help, call our tech support team @ 770-844-4200. In addition to having ready the information suggested in the flow chart, please have the following available:

- 1) **C-more** HMI part number including serial number with date code.



---

*NOTE: The "About C-more Programming Software..." dialog box will show a Firmware version. This is the current firmware version that is included with the programming software and does not reflect what firmware is actually loaded on your C-more HMI. See the following for details on how to check the firmware version.*

---

- 2) Programming software version that you are currently using. For example: Version 5.20. Having the software version number will allow our tech support team member to assess whether there are similar problems that have been reported when using the same version of the software. The programming software version can be found by clicking on "**About C-more Programming Software...**" selection under the **Help** pull down menu in the software. Also, it is always a good practice to visit the **Software/Firmware Downloads** area under the Tech Support section of the **AutomationDirect** website and check to see if you are using the latest version of the programming software. If you aren't using the latest software version, we suggest that you upgrade to see if this resolves your problem.
- 3) Firmware version of the **C-more** HMI. For example: V5.20. The firmware version can be checked by using the **System Setup Screens**, going to the **Information** menu under the **Main Menu**, and looking under the **General** tab for **Firmware: -Runtime**. The firmware version can also be checked by using the programming software, while connected to the panel, and clicking on the **Panel Information** selection under the Panel pulldown menu. As with the programming software version, it is important for our tech support associates to know which firmware version you are using so they can check on any known problems. As with the programming software, we strongly suggest that the firmware be updated to the latest version. Check for the latest version and download from the **Software/Firmware Downloads** area of the **AutomationDirect** website.

It is also helpful to have a copy of your project file for our tech support associates to use in troubleshooting a problem, so please be prepared to forward a copy of your project if it is requested.

# Troubleshooting Flow Chart

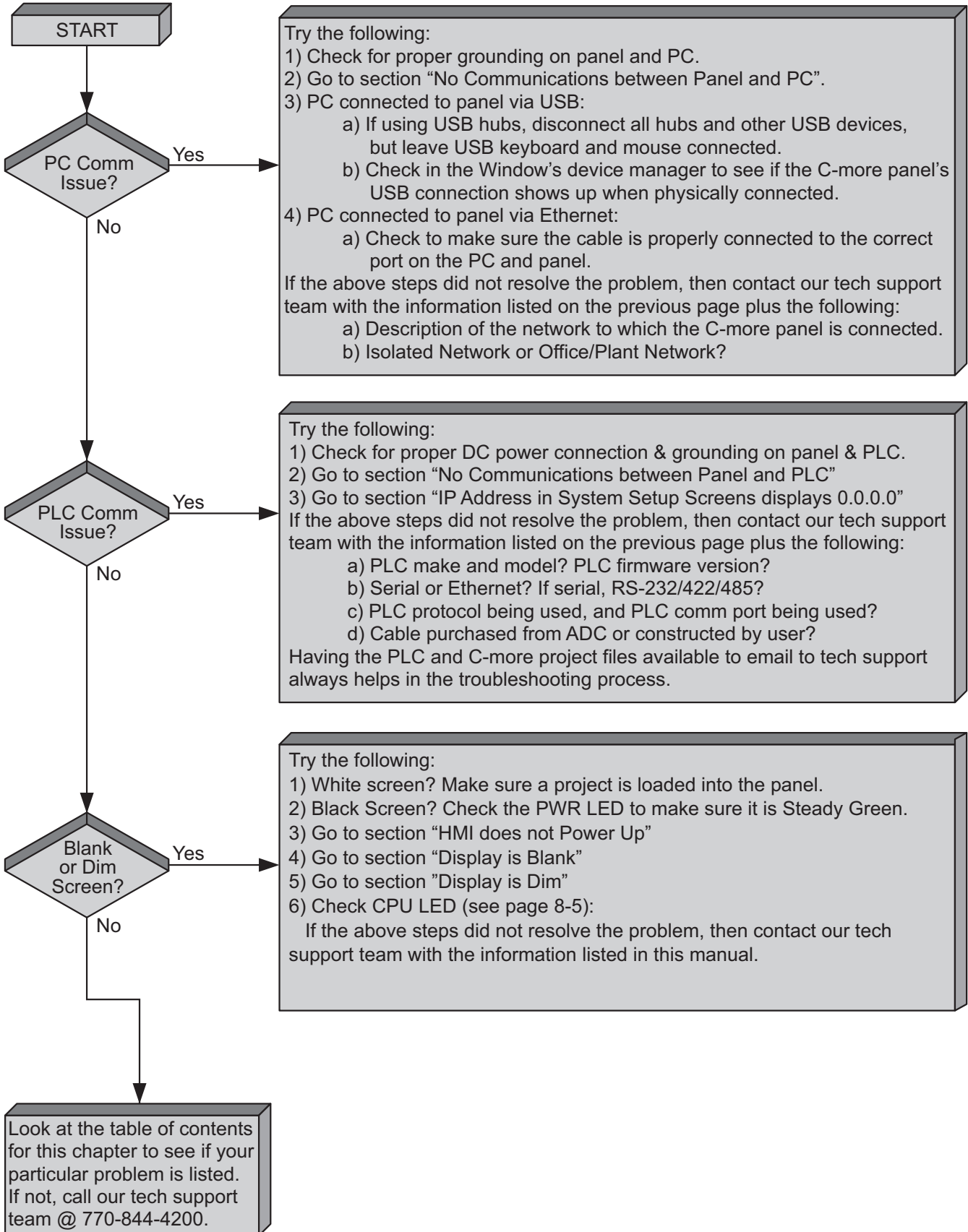

## HMI Does Not Power Up

- 1.) Check the status indicators on the front of the panel to see if the **Power LED (Green)** indicator is on. Refer to the diagram below. If the **Power LED (Green)** indicator is on and the panel was observed showing “Initializing...” during power up, but the display is now blank, go to the next troubleshooting tip, **Display is Blank**.
- 2.) If the **Power LED (Green)** indicator is off and the panel is being powered with a 12 or 24VDC power source, use a voltmeter to check the incoming DC voltage level. If the incoming DC voltage is zero, check any fusing that may be in the circuit. If the fuse is open, determine cause and replace. If the DC voltage level is out of range, the DC power source needs to be corrected or replaced.

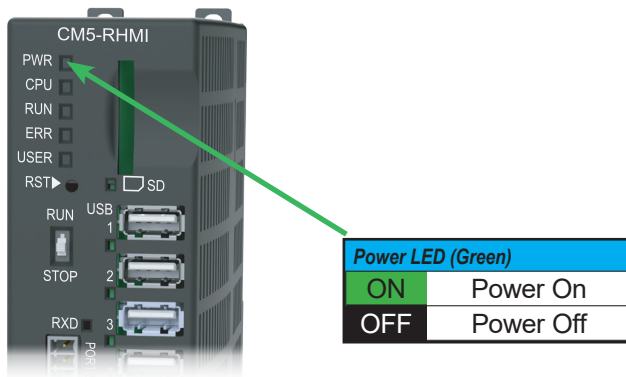

## C-more LED Status Indicators

The status indicators will show activity whether the serial communications is wired for RS-232 or RS-422/485.

Electrical noise, pulse generating wiring and/or improper grounding can also cause problems with communications. Refer to the **Electrical Noise Problems** section later in this chapter for additional help.

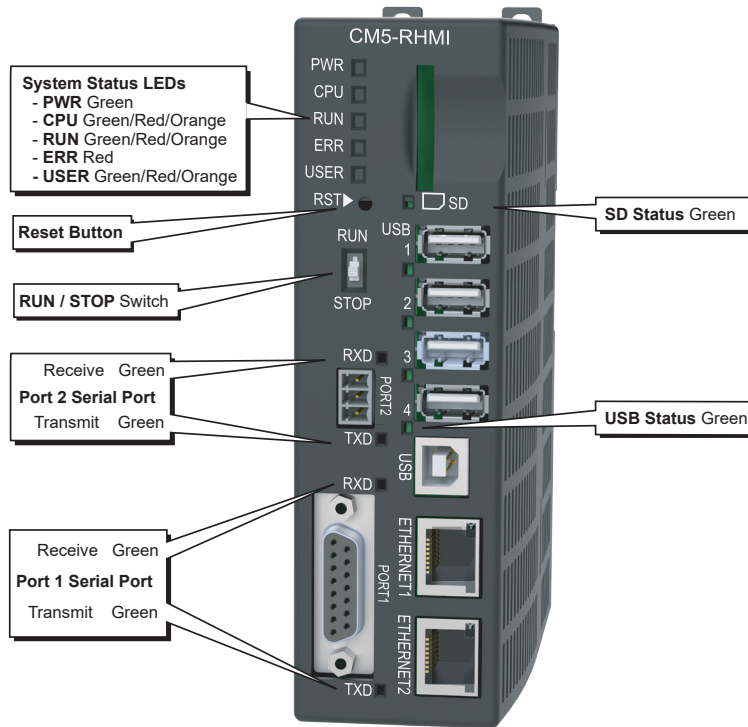

System Status LEDs				
	LED	CPU	RUN	ERR
State	Loading Project	–	Blinking Green (0.2s)	–
	Loading OS	Blinking Green (0.5s)	–	OFF
	CPU Running Normally	Green	–	OFF
	Project Loaded and Running	–	Green	–
	No User Project	–	Orange	–
	Reset to Factory Default	Blinking Green (0.5s)	Blinking Green (0.5s)	Blinking Red (0.5s)
	System Screen	–	OFF	–
	Password Required	–	Blinking Orange (0.5s)	Blinking Red (0.5s)
	Errors	Power Loss Detection	Blinking Orange (0.2s)	–
Memory Error		Red	OFF	Red
OS Error		Blinking Orange (0.5s)	OFF	Red
No Log Storage Found		–	Blinking Orange (0.5s)	Blinking Red (0.5s)
General Error*		–	Red	Blinking Red (0.5s)
Warning*		–	Blinking Orange (0.5s)	Blinking Red (0.5s)
Safe Mode		Orange	OFF	Red

\*Note - See Chapter 8 – Troubleshooting for General Error and Warning explanations.

## General Errors and Warnings

There are multiple causes for general errors and warnings. To get specific information for a general error and warning, connect the CM5-RHMI to a PC via USB. See Chapter 5 - System Setup Screens, Using RHMI USB Remote for more information.

- **General Errors**

- This file is not in a recognizable format
- Unsupported file version
- Not enough buffer memory
- Not enough memory to show all data points for trends
- Error in reading the file
- Multiple projects found in panel

- **Warnings**

- MRAM memory check sum error
- **C-more** runtime has detected corrupt data
- RUN --> STOP w/ Password
- Boot in STOP w/ Password
- No log storage found. \*Note\* - Data will not be logged if 'Ignore' is pressed.
- **WARNING** - The panel will stop
- Memory device is write protected

### CM5-RHMI Beep

Beep Functions	
Function	Beep Pattern
Boot	1-long, 2-short
Boot Error*	3-long
HDMI Connected	3-short
Reset to Factory Defaults	14 short beeps progressively closer together followed by 1-long beep.
Blink Screen	5-long
*Boot Errors Multiple Projects Write Protected SD Card No Log Storage Found Password Protected	

## Display is Blank

- 1.) Touch the screen to make sure the panel is not in the **Screen Saver** mode.
  - The **Screen Saver** will be turned off and the panel screen will display:
  - If a **PLC Address** is configured to control the **Screen Saver** and changes from **On** to **Off**.
  - When a connected touchscreen panel is touched.
  - When the screen is clicked by **Remote Access**.
  - When the **Alarm Event** of the **Event Manager** occurs. (Only when the **Display** setting of the **Alarm Event** is checked).
  - When there is a screen change by the **PLC**.
  - When an **Error** such as a **Communication Error** occurs.
- 2.) If the panel is not in **Screen Saver** mode, check the LED status indicators on the front of the unit. Refer to **Chapter 4 - Installation and Wiring, C-more LED Status Indicators** for more information.
  - Make sure the **CPU status LED (Green, Orange, Red)** is a **steady Green**.
  - If the **CPU status LED** is **blinking Orange (ON for 0.2 sec)**, then the supply voltage is below 12VDC
  - A **blinking Orange CPU (ON for 0.5 sec)** status LED indicates that the operating system could not be found. Reload the firmware to the HMI. If this does not resolve the problem, the panel must be replaced.
- 3.) There is always the remote possibility that a project has been transferred to the HMI that includes a screen that uses a black background and has no objects placed on the screen. To check for this possibility, access the **Main Menu** of the HMI **System Setup Screens** by moving the RUN / STOP switch to the STOP position. If the **System Setup Screen's Main Menu** is displayed, then most likely an empty black background screen is being displayed.

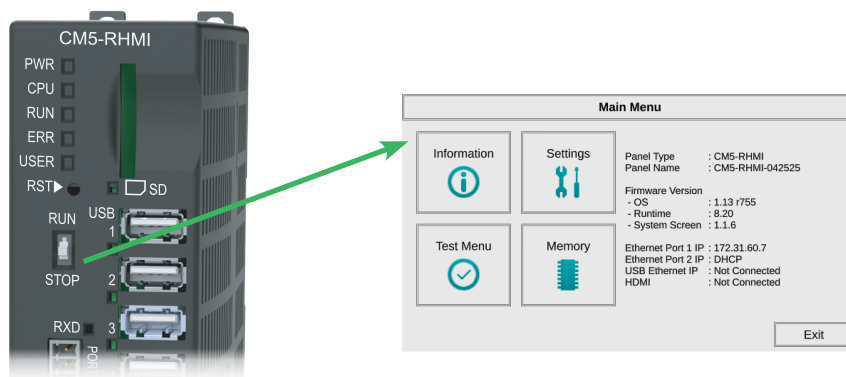

## No User Program

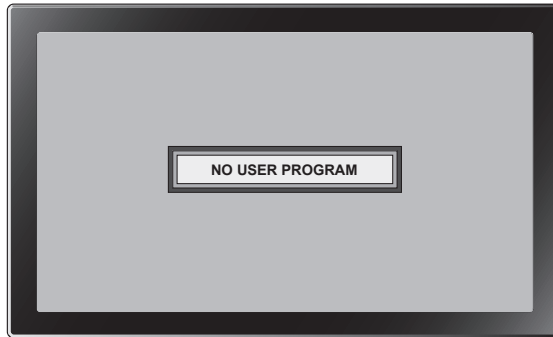

If a connected display is displaying the message “No User Program” after it has powered up, then either:

- the built-in Flash memory does not contain a recognized project, or
- an SD memory card is plugged into the SD1 slot, the project is set to boot from SD1 and there is no project on the SD memory card. Turn the power off, remove the SD memory card and turn the power back on.

Keep in mind that on power up, the HMI will read the project into the SDRAM memory from the location designated in the **Project Storage/Boot Location** setting in the in the **C-more** Software. This will either be the Built-in Flash memory or an SD memory card in the SD1 slot. If the location designated has no project, the upon power up or reboot NO USER PROGRAM will be displayed even if a project resides in the other location.



## Touch Screen Does Not Work

Make sure you're using a monitor with a compatible touch screen.

The **C-more** CM5-RHMI supports most HID compatible Resistive and pCap touchscreens starting with firmware version 8.20. The manufacturers and models that have been tested at the time of firmware version 8.20 release are:

CM5-RHMI Compatible Touch Screen Monitors		
Manufacturer / Distributor	Models	Touchscreen Type
Adlink	OM-215	pCap
Advantech	FPM-221W	pCap
Advantech	IDS-3215	Resistive
Atlas	ATM1500T	Resistive
Atlas	ATM1700T	Resistive
Atlas	ATM1900T	Resistive
Dynics	FX15PTUMAD	Resistive
ELO	E382790	SAW
ELO	ET1593L	pCap
Hope	HIS-ML15CTBH	Resistive
Hope	HIS-ML19.5CTBA	Resistive
Hope	HIS-ML19.5FPVB	pCap
Hope	HIS-ML19CTBH	Resistive
Hope	HIS-ML23-CTBD	pCap
HP	E24T G5	pCap
TruVu	VMTR-15C	Resistive
TruVu	ZBMT-18.5R	Resistive
ViewSonic	TD2465	pCap

### Select Touch Panel Driver

When the touchscreen is connected to the panel, the panel attempts to negotiate the proper driver. If the touchscreen does not respond, the panel may have selected the incorrect driver. Select Touch Panel Driver opens the screen below.

The screen below is shown with up to three Drivers, Driver #1, Driver #2, and Driver #3. Select each driver in turn and the Check Touch Panel screen opens.

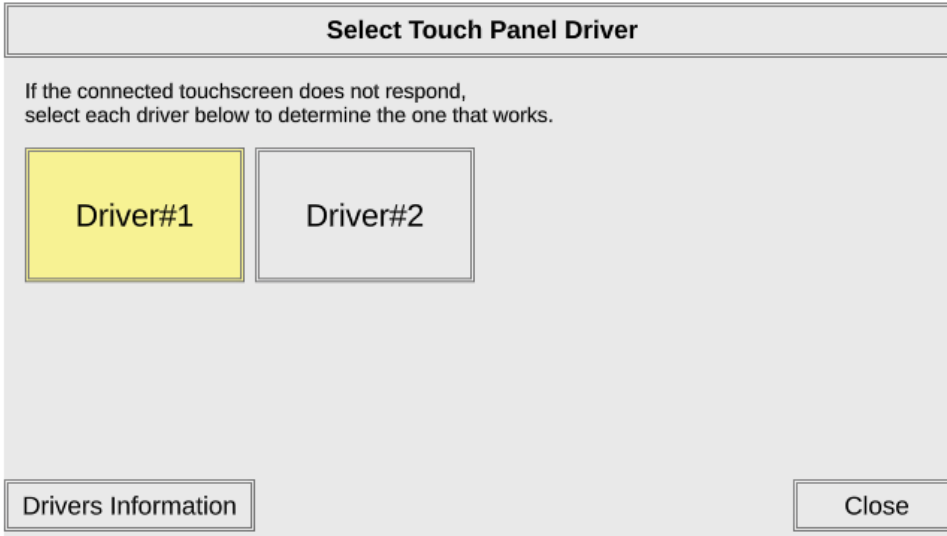

Touch the screen 3 times within 10 seconds.

- If the touch is registered, then the driver is used.
- If the touch is not registered, the screen will timeout.
- If this occurs, select the next driver and follow the same process.
- If all drivers have been selected without success, this indicates the panel does not have a driver for the selected touchscreen.

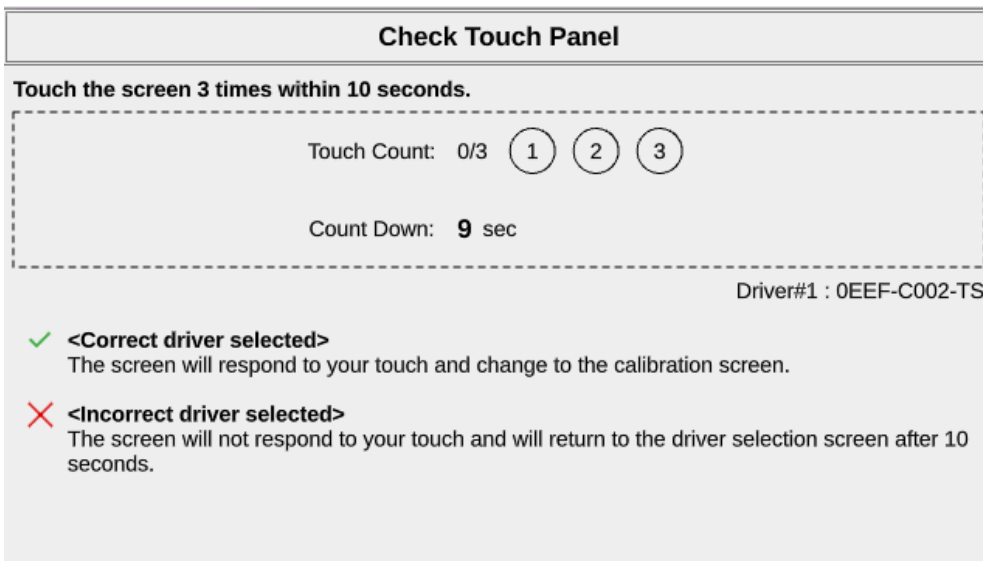

## Reporting Unsupported Driver to AutomationDirect

With the correct driver information, you can attempt add the driver to the panel firmware for a later release.

- 1) Select the Drivers Information button.
  - *The Touch Panel Drivers Information window opens as shown below.*
- 2) Record the information for all drivers displayed.
- 3) Contact Technical Support and provide this information to them.
  - *There is no guarantee the driver can be added, and the time required may not be feasible for your project. You may consider trying a different touch panel monitor.*

Touch Panel Drivers Information			
Driver	PID	Vender ID	Type
Driver #1	0EEF	C002	TOUCH SCREEN
Driver #2	0EEF	C002	MOUSE

## Calibrating the Touch Screen

Touch Panel Calibration Screen will open. Select all five calibration points (crosshairs) as they appear. Select them carefully and use a stylus if necessary for accuracy.

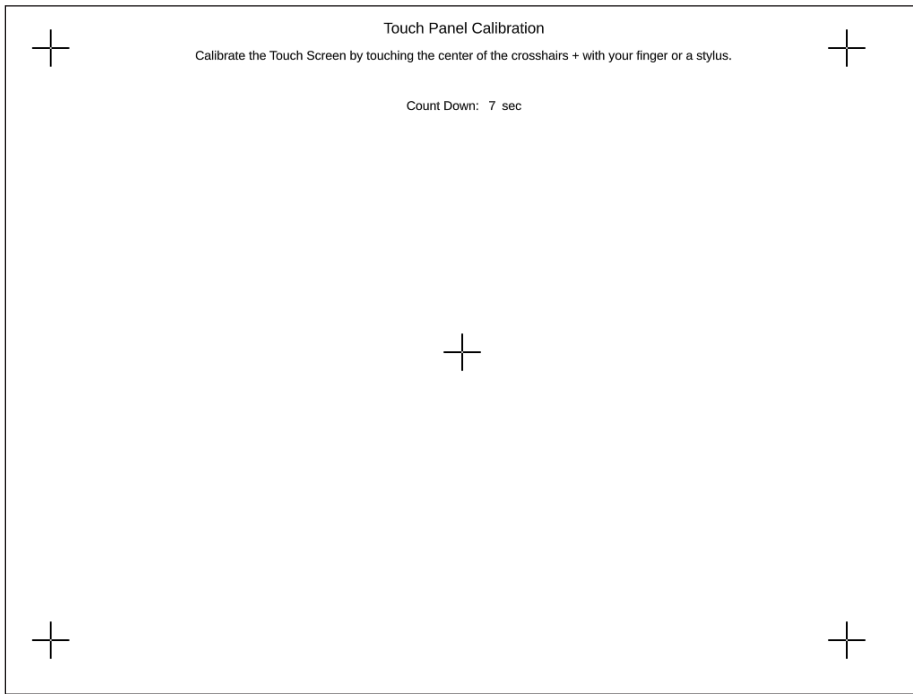

## Touch Screen Calibration is Not Correct

If the cursor does not move to the point you touch, calibrate the touch screen using a USB mouse. Follow these steps for proper calibration.

Switching the panel from Run to Stop will sometimes force a touchscreen calibration.

If it does not, then Reset Factory defaults will clear the calibration settings and load the default. You can Reset Defaults from the software Panel tab or by holding down the reset button for more than 15 seconds.

Switching to Stop Mode after Resetting factory defaults will open the Call Calibration Screen shown below. You have 10 seconds to select the screen and go to the screen calibration.

If this process does not work:

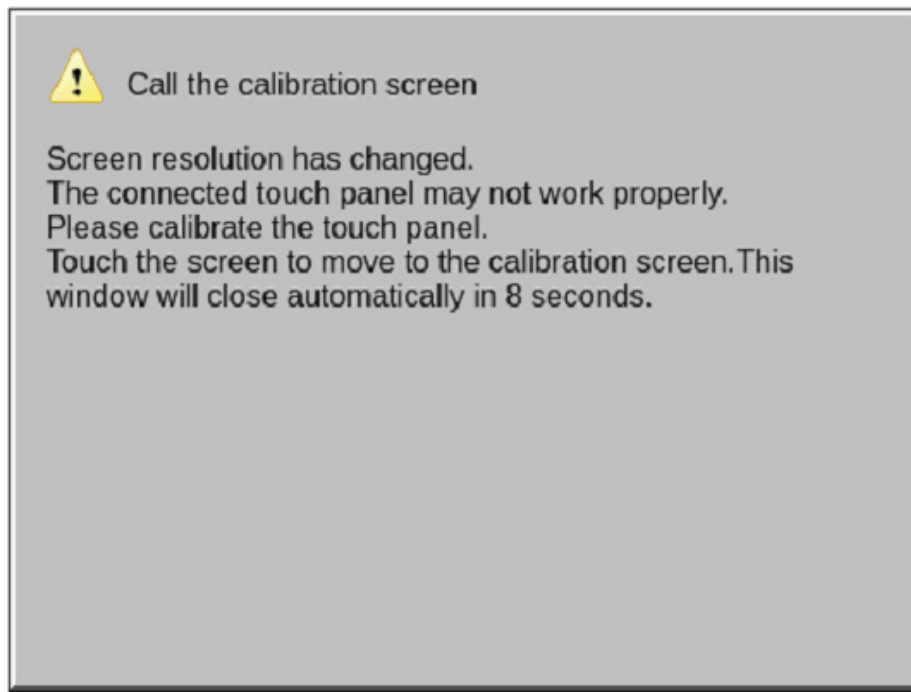

- 1) Move the CM5-RHMI RUN/STOP switch to STOP to access the System Screen.
- 2) Connect a USB mouse to one of the USB type A ports on the CM5-RHMI. The cursor should follow the mouse movement.
- 3) Use the mouse to access the Calibration screen. From the Main Menu select Settings, Touch Panel Touch Panel and Start Calibration.
- 4) From the Calibration screen, use your finger, not the mouse to touch each calibration crosshair as they appear. When all five points are touched, select OK to accept or Cancel.

## Safe Mode Recovery

If the panel power is interrupted during a firmware update, the firmware in the panel may become corrupt. If the firmware is corrupt, but the operating system is still intact, the screen below will open when power is reapplied to the panel. This is called Safe Mode

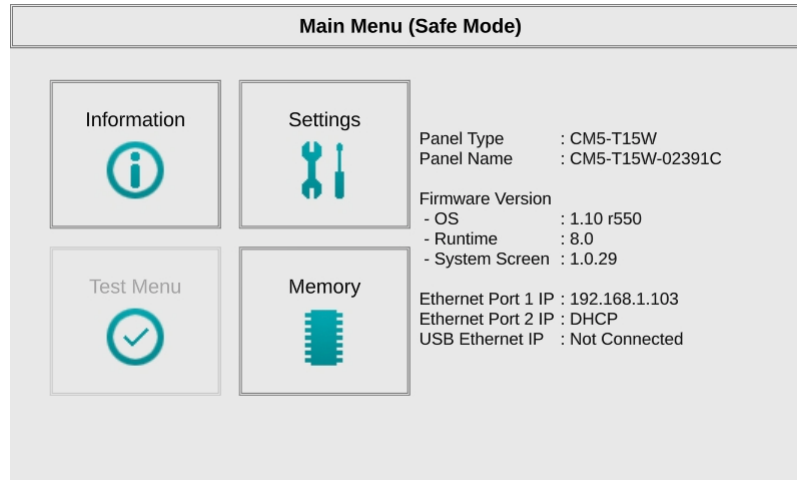

To recover, start the firmware update again making sure that there is a constant clean power supply.

### Safe Mode (ERR-202-5)

If the Firmware Update process is interrupted, the panel may reboot into **Safe Mode**. **ERR-202-5: Safe Mode is activated** will be displayed as shown below. If this happens, the following screen will appear on the panel.

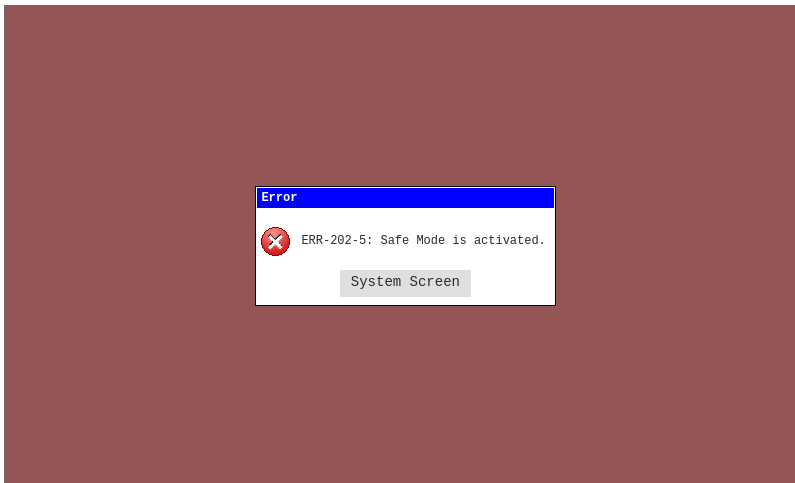

Select the System Screen button to open the System Screen on the panel.

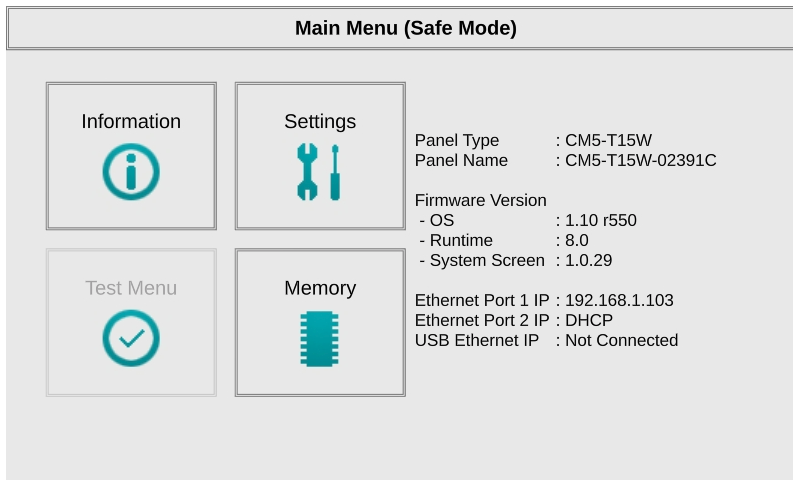

Notice some features are not available.

To recover the **C-more** panel, first eliminate the cause of the original failure (i.e. - whatever caused the firmware update failure like a loose cable connection or a power failure during update). Connect to the panel either by USB or Ethernet. Using the **C-more** software v8.20 or later, perform the Firmware Update again.

## USB Driver Troubleshooting

Check the USB driver using Windows Device Manager:

With the **C-more** panel connected to the PC, on the PC, open **Control Panel--> System -->Hardware tab --> Device manager**. Next expand “Network adapters”. The **C-more** driver is named **C-more CM5** as shown below:

If the **C-more** programming software Communication Config dialog USB indicator is red, and the driver does not appear in Device Manager,

- 1) Unplug both end of the cable and replug them in.
- 1) If that does not establish communication, plug into a different USB port on the PC.
- 1) If there are any USB hubs or other devices being used, temporarily eliminate them to see if this solves the problem.
- 1) Reinstall the **C-more** HMI USB driver.

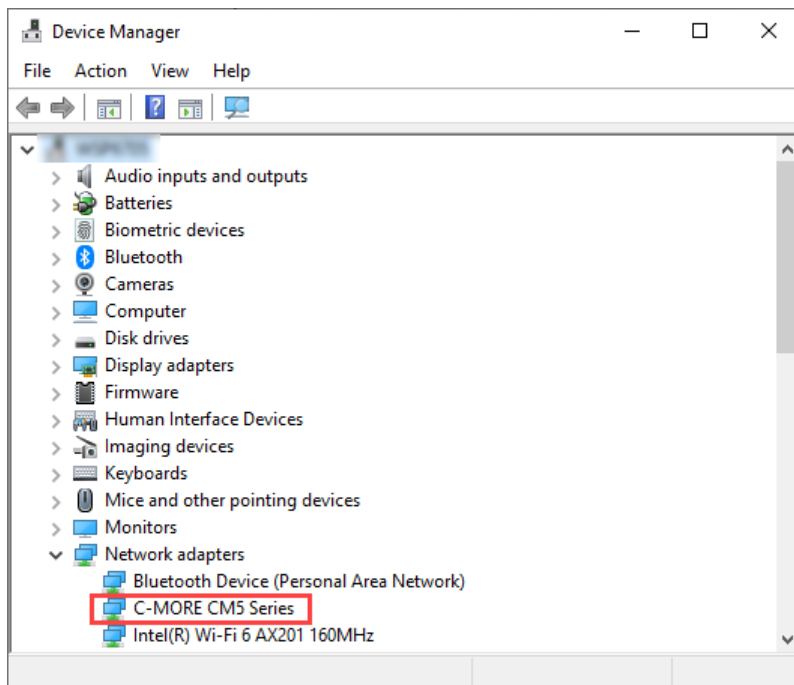

The **C-more** USB driver installation utility is bundled with the **C-more** software installation files. If you have a **C-more** software CD, the file is in the root, called CM5\_USBDriver.exe.

- 1) If you downloaded the software, when you extracted the files, the CM5\_USBDriver.exe was extracted to the location you chose. First, close the **C-more** software and disconnect the USB cable from the PC. Then, browse to CM5\_USBDriver.exe and run it.
- 1) Plug the USB cable into the PC and the **C-more** panel.
- 1) The Found New Hardware Wizard will prompt you to search for the driver. Select “No not this time”, click Next. Select “Install the Software automatically (Recommended)” click **Next**. Click **Continue Anyway** in the Windows Logo warning popup. Click **Finish**.
- 1) Open the project in the **C-more** software. The Communication Config (and Transfer Project) USB indicator should be green.



## No Communications between Panel and PC (Personal Computer)

There can also be a conflict with another Ethernet connection that may be using the same **IP Address**. You may want to check the setup both in the touch panel and also in your PC. As a starting point, it is best to start with an assigned IP Address and Subnet mask, mainly to eliminate IP addressing conflicts. Use the **C-more** programming software and open the **Panel Network** dialog box. Click on the **Ethernet Port** tab to display the dialog box used to set up the touch panel's **Ethernet** port.

Another cause of an **Ethernet** communications problem that may be encountered, is the touch panel doesn't show up in the node list, which can be caused by the PC having a firewall.

The figure below shows the **Panel Network** dialog box with the **Ethernet Port** tab opened. The **Save settings to Project** check box is checked and we are using the **Use the following IP Address** selection by checking its radio button. **The subnet (192.168.100.X) and the subnet mask (255.255.255.0) must be the same for both the panel and the PC.**

See the **C-more** programming software on-line help for additional details regarding the **Panel Network**.

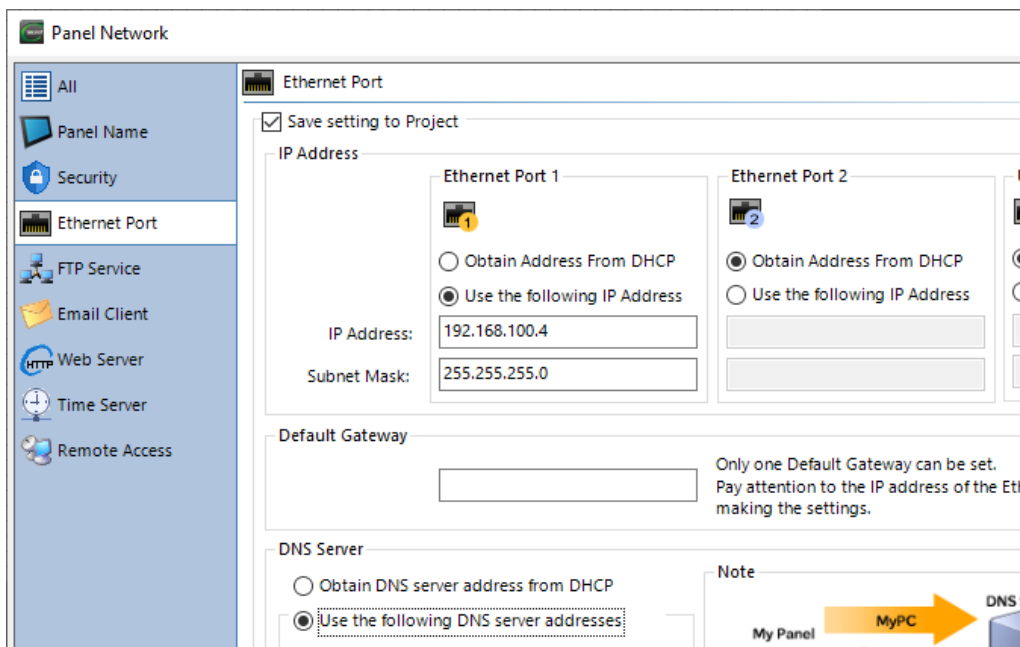

The IP Address assigned to the touch panel can also be checked or edited by using the system setup screens built into the touch panel. See Chapter 5: System Setup Screens for additional information.

## No Communications between Panel and PC (Personal Computer) (cont'd)

The *C-more* software will then identify the USB connection with a green indicator.

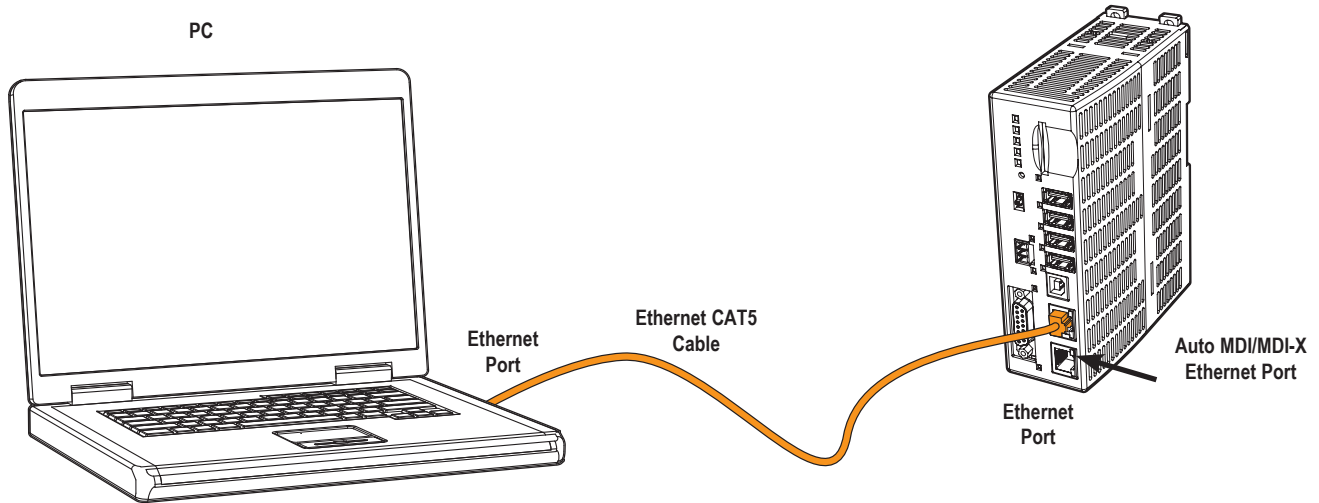

This Communication indicator appears on the Panel tab in the Navigation window and in the Project Transfer or Read from Panel windows.

## No Communications between Panel and PC (Personal Computer) (cont'd)

The figure below shows a different example of the panel's System Setup Screens Ethernet Port dialog box for configuring the Ethernet port.

Network Settings			
	Ethernet Port 1	Ethernet Port 2	USB Ethernet Port
Obtain Address From DHCP :	<input type="radio"/>	<input type="radio"/>	Not Connected
Use the following IP Address :	<input checked="" type="radio"/>	<input checked="" type="radio"/>	
IP Address :	<input type="text" value="192.168.1.135"/>	<input type="text" value="10.11.250.10"/>	
Subnet Mask :	<input type="text" value="255.255.255.0"/>	<input type="text" value="255.255.255.0"/>	
Default Gateway :	<input type="text" value="192.168.1.1"/>		
<input type="radio"/> Obtain DNS Server Address from DHCP <input checked="" type="radio"/> Use the following DNS Server Address			
Preferred Address :	<input type="text" value="8.8.8.8"/>		
Alternate Address :	<input type="text" value="0.0.0.0"/>		
		<input type="button" value="OK"/>	<input type="button" value="Cancel"/>

## No Communications between Panel and PC (Personal Computer) (cont'd)

Another option for accessing the **IP Address** assigned to the touch panel is to use the **C-more** Programming Software. Open the Navigation window's Panel tab and click on the **Browse** button under the **Communication** window at the bottom. This will open the **Ethernet Connection Setup** window. The **Online Link List** tab will show all of the connected panels. If none are shown, try clicking the **Browse Network** button to search for attached devices. Double click on the **Panel Name** you want to access and this will bring up the **Change IP Address** window. In this window changes can be made to the panel's name, IP address, subnet mask, and default gateway.

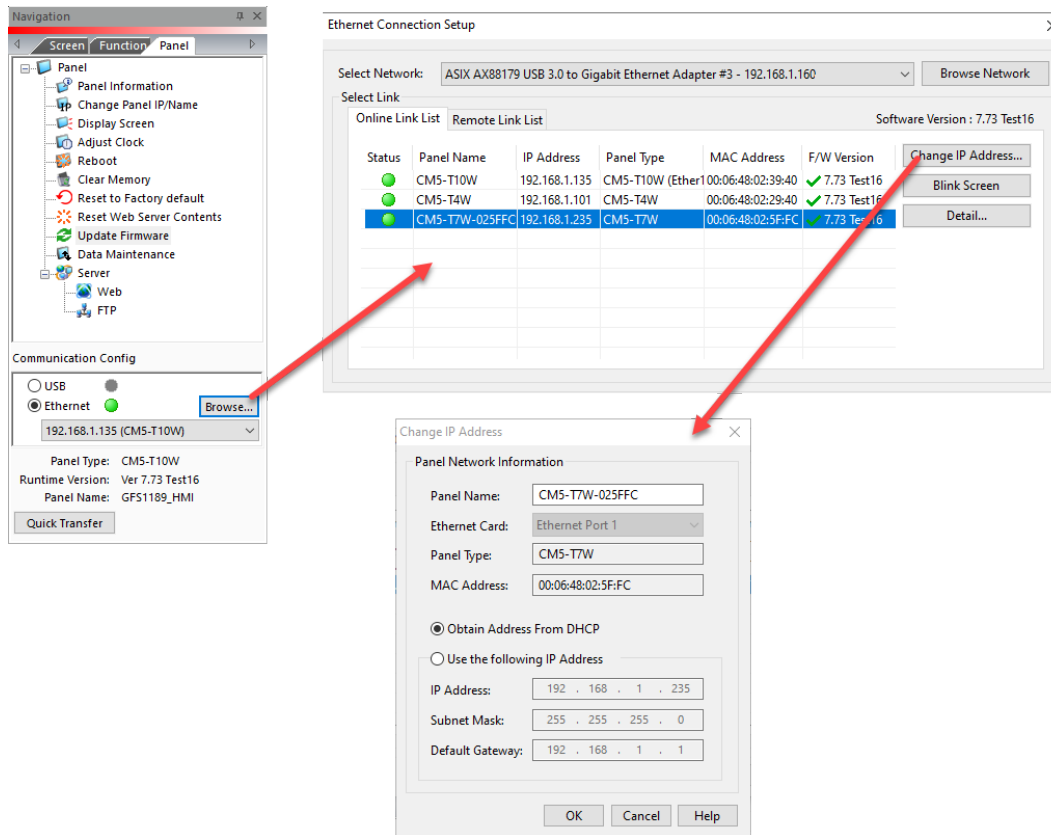

## No Communications between Panel and PC (Personal Computer) (cont'd)

Check the **IP Address** setting of the PC by opening the Windows operating system's **Control Panel**.

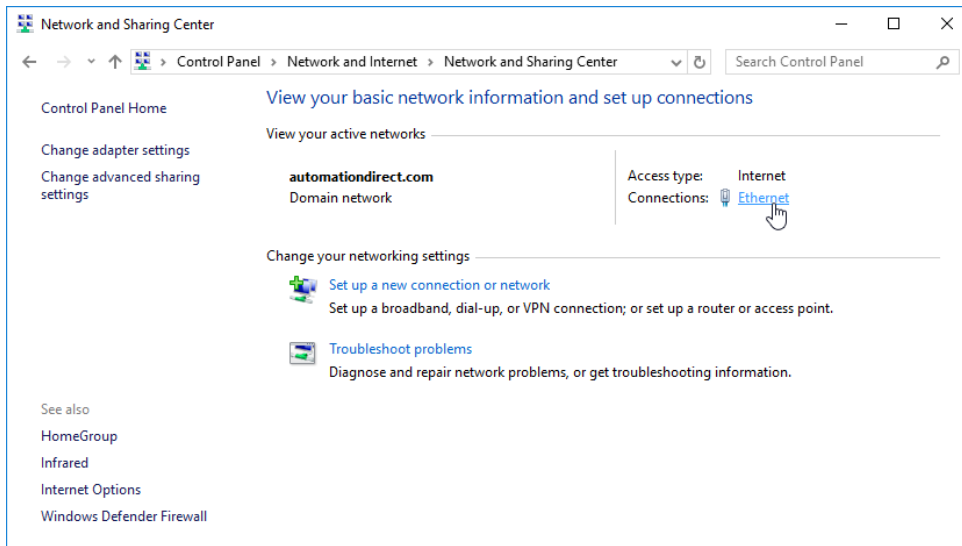

Select **Network and Internet** and then **Network and Sharing Center**. Click on **Ethernet** as shown below.

The Ethernet Status dialog will open. Select **Properties** and choose the appropriate **Internet Protocol** in the connections list. Select **Properties**. The **Internet Protocol Properties** window will open. Make sure the **Subnet Mask** is set the same for both the HMI and PC and also make sure that the **IP Addresses** do not conflict.

# No Communications between Panel and PC (Personal Computer) (cont'd)

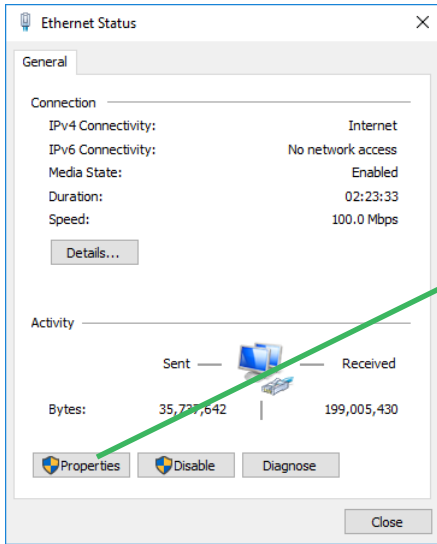

**NOTE:** If a DHCP Server is being used to obtain the IP Address for the PC, there are ways to identify the IP Address. For example, if using Windows 10, open a Command Prompt (Run > CMD) and type `IPCONFIG /ALL`. A list of all Ethernet assignments for the PC will be shown.

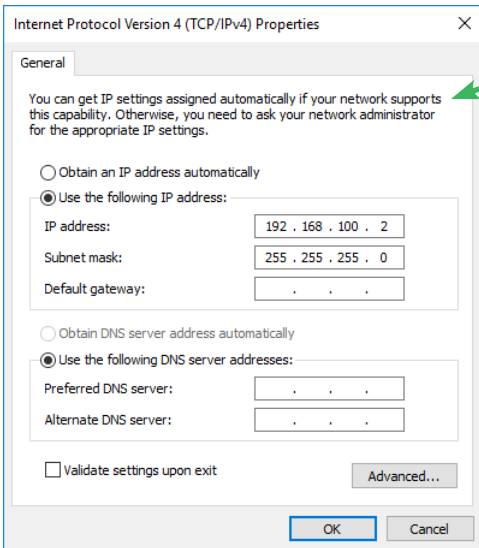
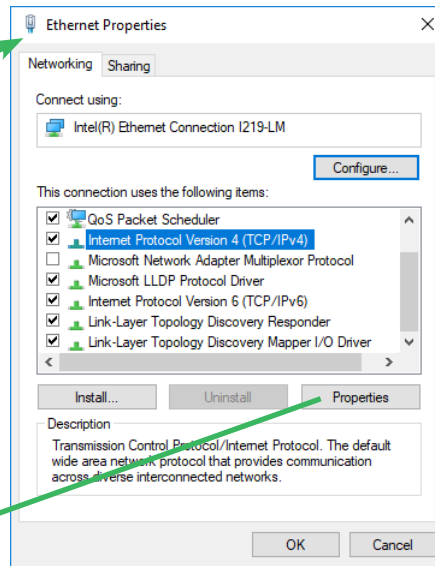

# No Communications Between Panel and PC (Personal Computer) via USB

The **C-more** HMI is programmed using the **C-more** Programming Software, CM5-PGMSW. The developed project is transferred from the PC to the HMI by either a USB or an Ethernet connection between the two. (Ethernet available on full feature units only.)

If using USB, then a USB type AB programming cable, such as p/n USB-CBL-AB15, should be used to make a connection between the panel's USB Port, Type B and a USB port on the PC. The **C-more** Programming Software will install a USB driver on the PC during the software installation.

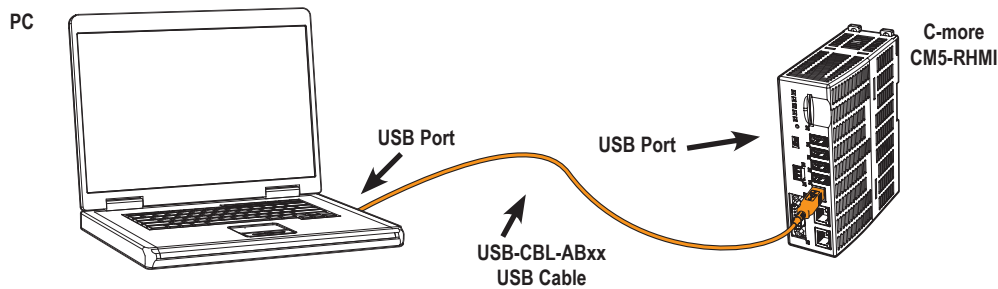

If the USB connection to the panel is recognized by the PC, you will hear the Windows device-recognized-sound when the powered panel is connected to the PC. The driver will appear in the Windows Device Manager under Network adapters as If the USB connection to the panel is recognized by the PC, you will hear the Windows device-recognized-sound when the powered panel is connected to the PC. The driver will appear in the Windows Device Manager under Network adapters as **C-more** CM5.

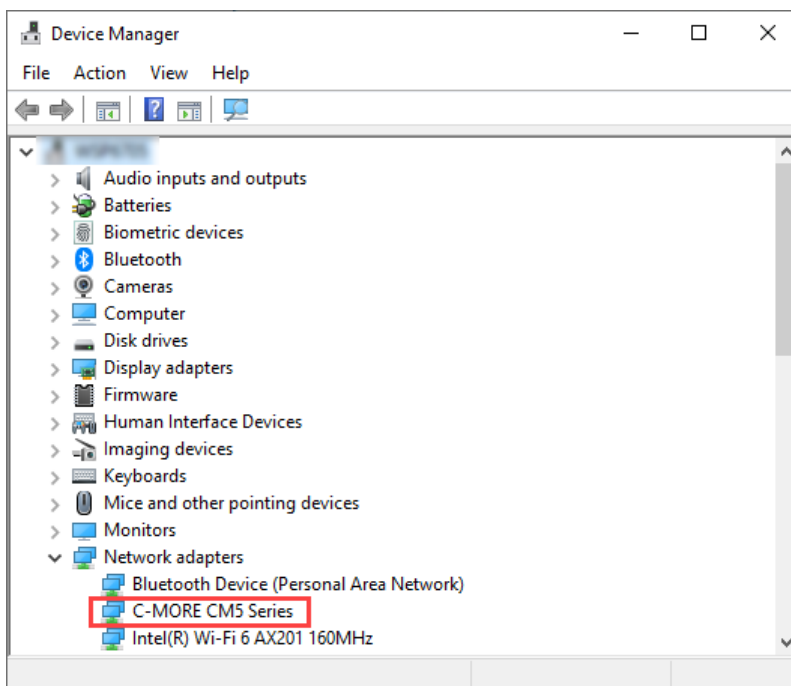

## No Communications between Panel and PC (Personal Computer) via USB (cont'd)

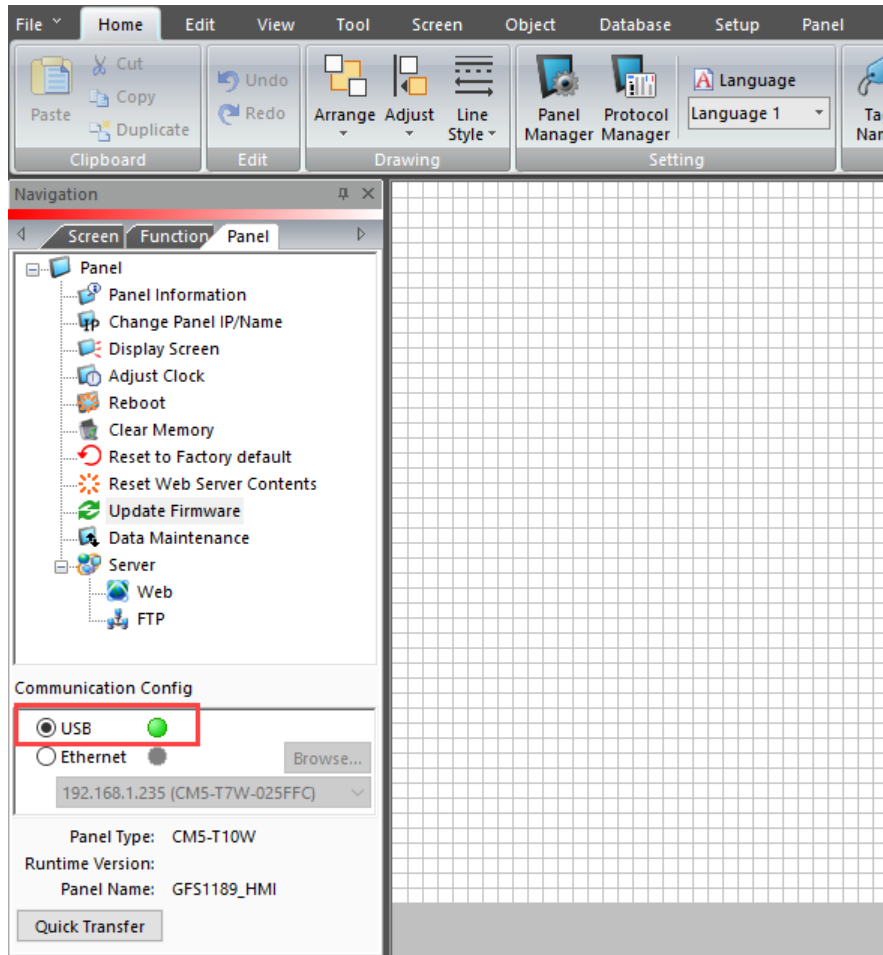

The **C-more** software will then identify the USB connection with a green indicator.

This Communication indicator appears on the Panel tab in the Navigation window and in the Project Transfer or Read from Panel windows.



## No Communications Between Panel and PC (Personal Computer) via Ethernet

When using an **Ethernet** connection to communicate between the HMI and the PC and the communications does not seem to be working, the first area to check is the Ethernet status indicators located next to the **10/100 Base-T Ethernet Port** on the front of the CM5-RHMI. The **Link Status LED** must be displaying a steady or blinking green.

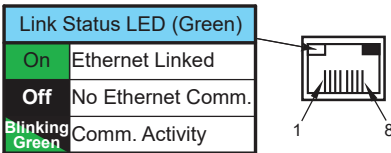

If using **Ethernet**, there are two basic ways to make the connection. You can use an **Ethernet** cable to make a direct connection between the HMI and PC or use an **Ethernet** cable from the HMI to a switch and then to the PC.

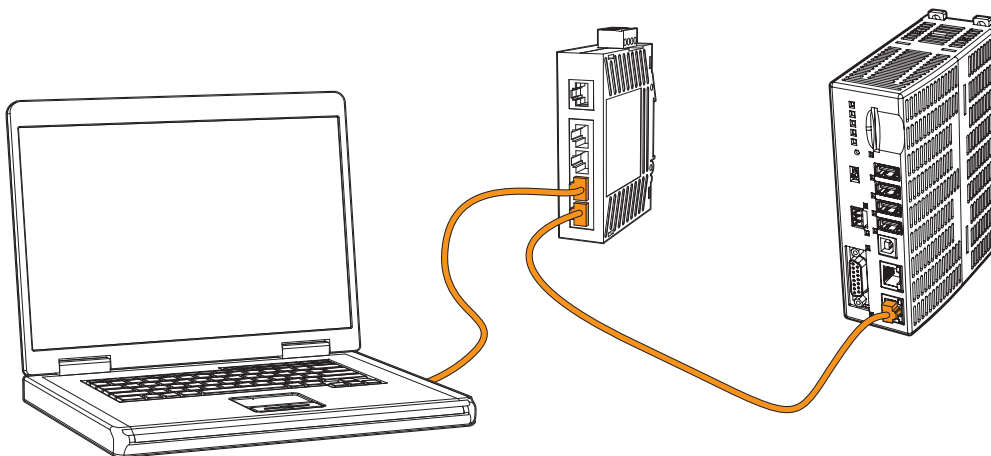

Use the **C-more** programming software to check the status of the **Ethernet** communications. From the **Navigation** window, select the **Panel** tab. At the bottom of the **Panel** tab is the **Communication Config** dialog box. Select the **Browse** button. If the connection is working the panel will be listed in the online link list. Select the panel and then select OK. If the **Ethernet** communications to the panel is working, then there should be a “green” indicator next to the **Ethernet** selection. There should also be an **IP Address** shown in the browse box below the **Ethernet** selection. If the **Ethernet** radio button is “red”, then you will need to check your **Ethernet** cables and connections or **Browse** for the panel.

## No Communications between Panel and PLC

The communications between the **C-more** touch panel and designated PLC or controlling device can be accomplished by either a serial connection or by an **Ethernet** connection. The CM5-RHMI includes a 15-pin RS-232/422/485 port and at least one Ethernet port. The 10-inch through 22-inch panels include a 3-wire RS-485 connection.

- 1) If the touch panel and PLC are connected serially and the communications have seemed to stop working, then first check the **TxD** and **RxD** status indicators on the front of the CM5-RHMI at the connected port for activity.

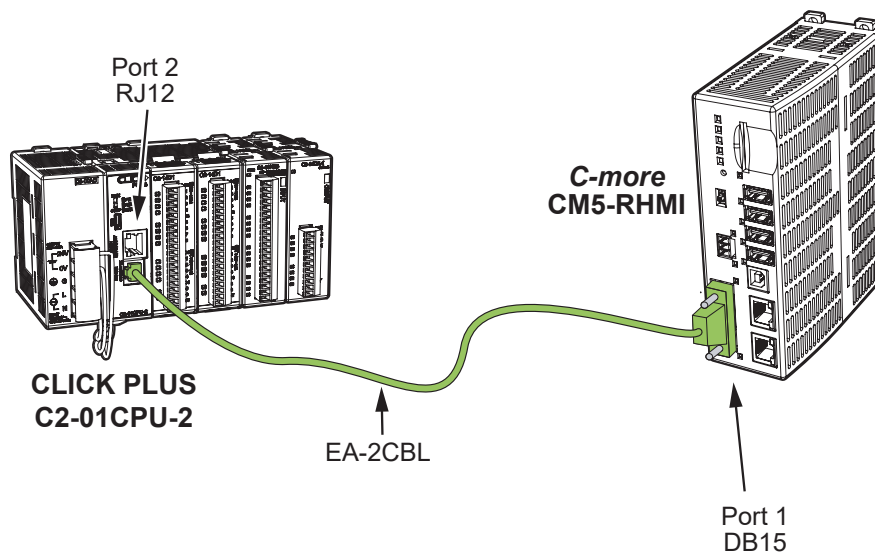

If there is no activity on one or both the TxD and RxD status indicators, then it should be suspected that either:

- *serial comm port settings are incorrect*
- *the cable is bad and needs to be replaced*
- *the serial port on the panel is defective*
- *the PLC serial port is bad*
- *No TxD also can indicated no tags being polled on device*

## No Communications between Panel and PLC (cont'd)

The status indicators will show activity whether the serial communications is wired for RS-232 or RS-422/485.

Electrical noise, pulse generating wiring and/or improper grounding can also cause problems with communications. Refer to the **Electrical Noise Problems** section later in this chapter for additional help.

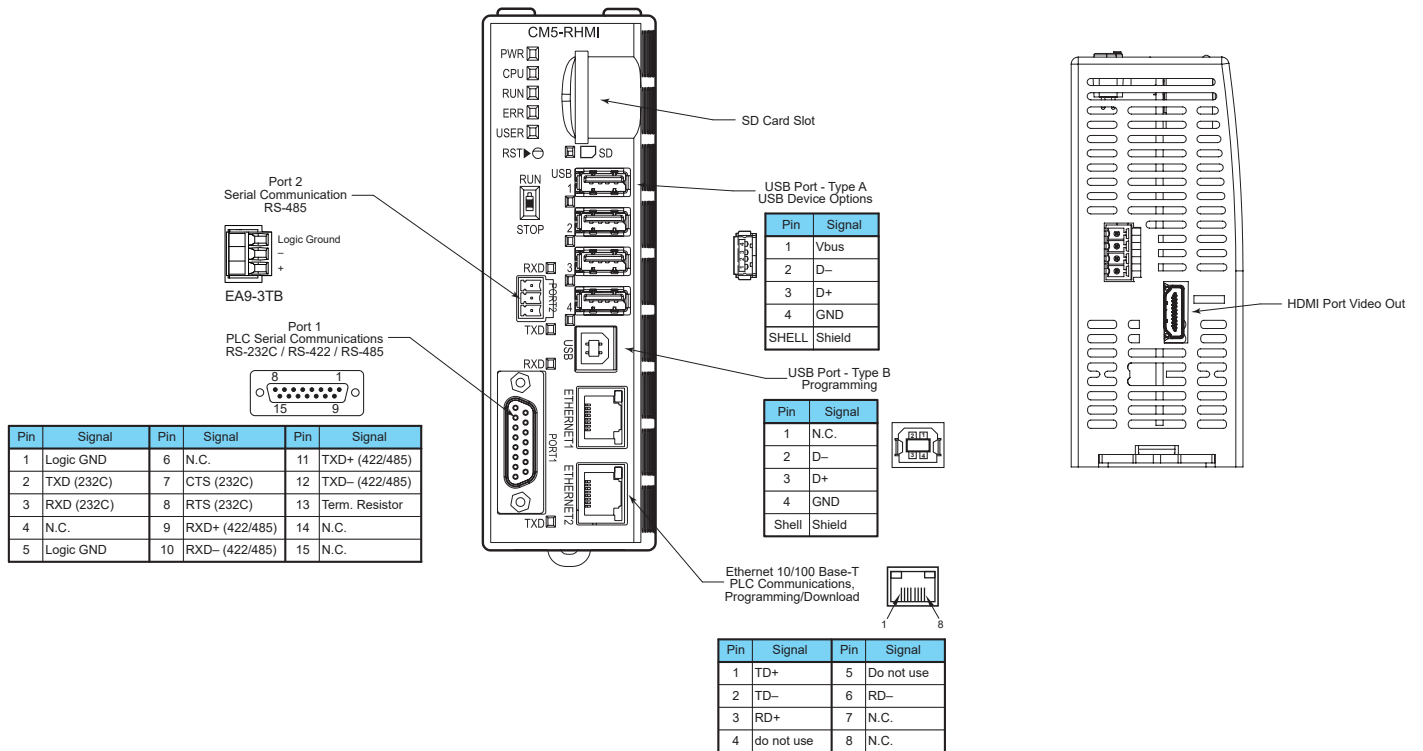

## No Communications between Panel and PLC (cont'd)

The serial ports on the **C-more** HMI can be tested using the HMI's system setup screens. Access the **Main Menu** of the HMI's system setup screens, press the **Test Menu** button, then press the **Test Serial Port** button and select the appropriate port tab. You will need to fabricate a **Loop Back Connector** for the type of serial connection that is being used in your application, either RS-232 or RS-422/485, per the wiring diagrams shown below. Plug the loop back connector into the panel's 15-pin PLC serial communications port and then press the **Loop Back Test** button to run the test. See **Chapter 5: System Setup Screens** for additional information.

Loop back connector wiring diagrams:

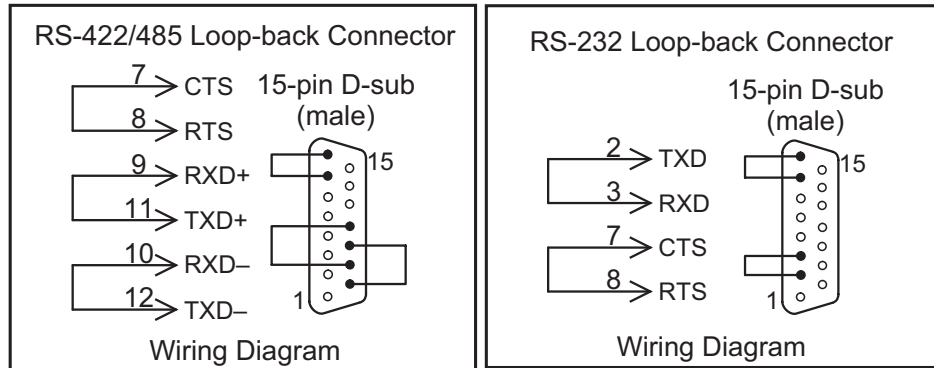

System setup screens **Test Comm. Port** dialog boxes:

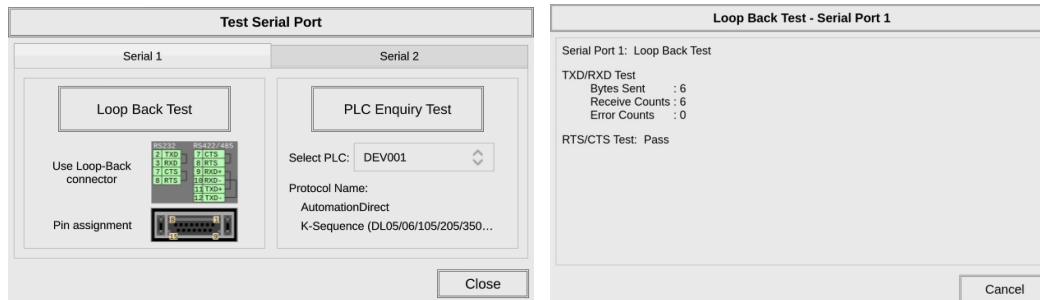

The **PLC Enquiry Test** can also be performed to determine if the **Ethernet** communication is working correctly between the panel and designated PLC.

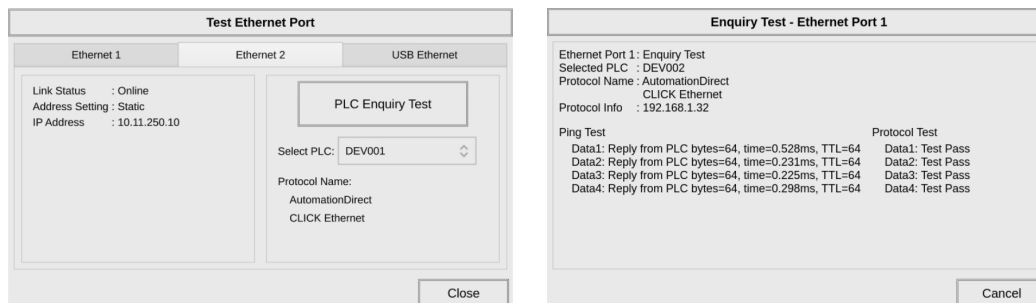

**NOTE:** The CM5-RHMI does not have a Serial 3 Port.

## No Communications between Panel and PLC (cont'd)

If using an **Ethernet** connection between the HMI and the PLC, and there is a problem with the communications, the first area to check is the **Ethernet** status indicators located next to the **10/100 Base-T Ethernet Port** (shown below) on the HMI.

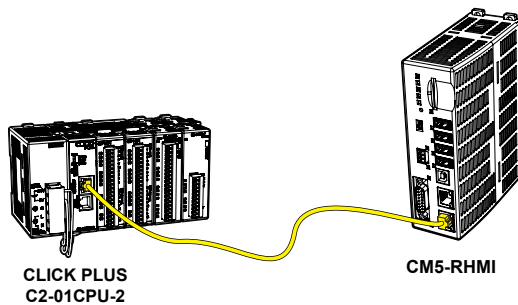
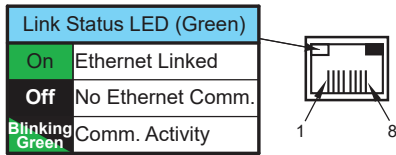

There are two basic ways to make the connection. You can connect directly from the HMI to the PLC or

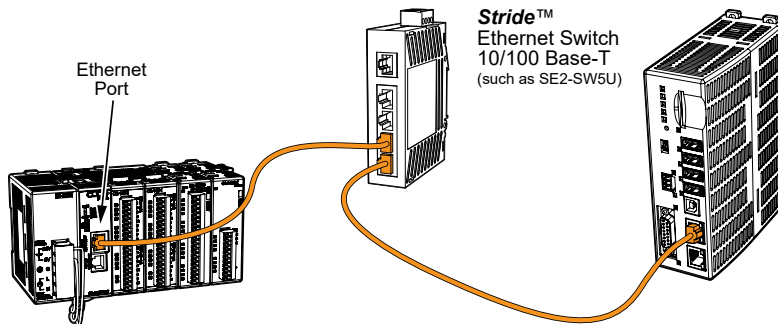

connect from the HMI to a switch that is also connected to the PLC.

Check the status indicators that may be included with the **Ethernet** communications module or device that is part of the PLC. Refer to the PLC's Ethernet user manual for further troubleshooting information.

## No Communications Between Panel and PLC (cont'd)

The Ethernet port on the **C-more** touch panel can be tested by using the panel's system setup screens. Access the **Main Menu** of the panel's system setup screens, press the **Test Menu** button and then press the **Test Ethernet Port** button. Select the Ethernet tab in the **Test Ethernet Port** dialog box. Make sure the Ethernet port is connected to an Ethernet switch or other Ethernet communications device select a PLC from the drop down selection box, and then press the **PLC Enquiry** button to run the test. See **Chapter 5: System Setup Screens** for additional information.

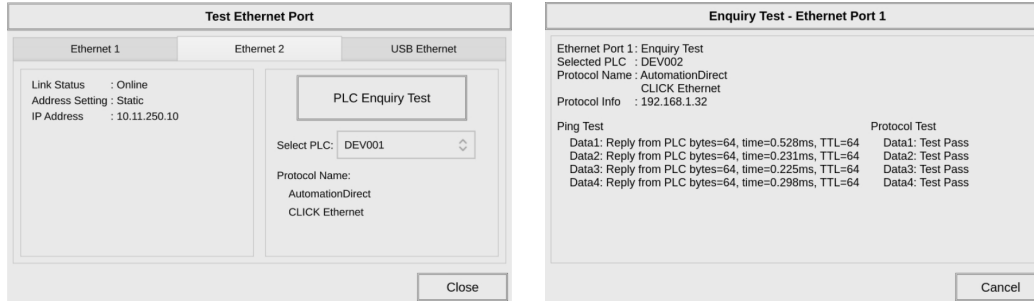

If a PC running the **C-more** programming software is connected to the **Ethernet** network that is also connected to both the touch panel and PLC, then certain functions in the software, such as the **Panel Information** window can be used to help troubleshoot problems with the touch panel's communications and operation. See the **C-more** programming software's on-line help for additional information.

### IP Address in System Setup Screens Displays 0.0.0.0



**NOTE:** If entering an **IP Address** for the **C-more** HMI using the **System Setup Screens**, and the **IP Address** keeps displaying **0.0.0.0**, even after entering an **IP address**, the panel is not functionally connected to an active network. Either the cable, hub, or switch is bad. The entered **IP Address** is stored in the panel's memory but won't show up until a good connection is established. Keep in mind that if in the **C-more** programming software's **Panel Network** dialog box, under **Ethernet Port**, you have checked the **Save settings to Project** check box and have entered an **IP Address** of **0.0.0.0**, then anytime the project is transferred to the panel, the panel's **IP Address** will be overwritten with the entered address.

## Difficulty Connecting to the Panel over the Internet (Web Server and Remote Access Features)

- 1) Refer to the software help file topics **Panel Network** and **Remote Access Setup** for information on configuring the Remote Access accounts, the Web Server Function and the panel IP Attributes.
- 2) In the Ethernet Port window, if DHCP is selected for assigning the IP address, verify the correct address of the panel. The IP address assigned by DHCP may change over time.
- 3) Note that the Web Server Function must be enabled in the Web Server window before the Remote Access Server Function can be accessed on the panel.
- 4) Verify that the correct TCP ports have been opened and forwarded on the router controlling access to the network where the **C-more** panel resides.
- 5) If two **C-more** HMIs are on a network behind a firewall and they have the same **Remote Access port number**, the router will use the first entry in the Port Forwarding setup that it encounters. The same **C-more** HMI will always come up even if the two HMIs have two different Web Server Port numbers.
- 6) When entering the URL in Internet Explorer to connect the **C-more** web server using a port number other than the default (80), be sure to use the full URL text including the prefix “http://”. The URL should be http://xxx.xxx.xxx.xxx:aaaaa where xxx.xxx.xxx.xxx is the IP address of the HMI and aaaaa is the port number configured in the Web Server window of the Panel Network setting.

## PLC Protocol Error Codes

The **C-more** HMI includes built-in PLC communication protocol diagnostics that monitor the exchange of data between the panel and the PLC. The diagnostics look for the proper exchange of data, correct handshaking signals, addressing errors, incorrect data bytes, wrong packet format, etc. The diagnostics also monitor and report any of the errors that the designated PLC would normally generate if there is a problem with the PLC's communications. Each brand of PLC has its own unique set of diagnostic errors that are typically communicated over the PLC's communications port. The PLC generated errors are interpreted by the **C-more** software. See the PLC manufacturer's user manuals for additional details on the designated PLC's errors.

If a **C-more** communications error does occur, the error message will be displayed in the upper left of the **C-more** screen and the **Error Code** is recorded in the panel's error log. If a PLC error occurs, the PLC error code number will appear across the top of the screen and the PLC error message may not be included in some cases. The error log can be viewed using the system setup screens. See **Chapter 5: System Setup Screens** under the **Information** window to bring up the Error tab which includes a description of the logged data.

A detailed list and description of the various PLC protocol errors can be found in **Appendix A: PLC Protocol Error Codes**.

Error Codes for <i>Direct Logic</i> – K-Sequence		
Error Code	Error Message	Description
PLC-001	PLC Communication Timeout (for single PLC) %Device% PLC Communication Timeout (for multiple PLCs, such as RS-422/485)	A timeout occurred after sending a request to the PLC %Device%. %Device% indicates the device name, such as DEV001. Example error message for multiple PLCs: DEV001 PLC Communication Timeout
PLC-002	NAK received from PLC	A negative acknowledgement (NAK) control code has been generated during a read/write request.
PLC-004	STX is not found	A Start of Text (STX) control code was not found in the data packet received from the PLC.



## HMI Runtime Errors

The **C-more** HMI includes built-in diagnostics that check for proper operation of the panel when it is running a project that has been transferred to its memory. Faults detected while the panel is running will produce a “Runtime” error. These errors are displayed in the upper left of the panel’s display and are also recorded in the panel’s error log. The error log can be viewed using the system setup screens. See **Chapter 5: System Setup Screens** under the **Information** window to bring up the **Error** tab which includes a description of the logged data.

A detailed list and description of the various HMI runtime errors can be found in **Appendix B: HMI Runtime Errors**.

No.	Error Log Code	Error Message Located at upper left of screen	Error Message Tag	Tag Error Code Value	System Screen Info > Error	Cause
<b>Log Error</b>						
1	RTE-001	Log Failed. Not enough Memory Space in %Device%	SYS ERR ERRORCODE	2001	MM/DD/YY HH/MM/SS Error Code RTE-001	The size of the destination memory is not large enough to store the data.
2	RTE-002	Log Failed. %Device% cannot be found	SYS ERR ERRORCODE	2002	MM/DD/YY HH/MM/SS Error Code RTE-002	No device available or the device is defective.

## Panel Constantly Displays “Initializing” when Powering Up

If the HMI constantly displays a message reading “Initializing” while powering up, then check the following possible causes.

- 1) **C-more** supports USB 1.1 and 2.0 memory devices. Ensure that the USB device is 1.1 or 2.0 or backward compatible to support version 2.0
- 2) The project that is loaded into the panel’s internal SDRAM memory is corrupted. Either use the **C-more** programming software to clear the panel’s memory and re-transfer the project to the HMI or move the RUN /STOP switch to the STOP position. Select the **Memory** menu and use either **Clear Memory** or **Set to Factory Default** to clear the panel’s memory and re-transfer the project to the HMI. (see Chapter 5 - System Setup Screens)
- 3) An SD memory card has been plugged into an SD card slot and the SD card either has no project stored on it or the project is corrupted. Remove the SD memory card from the SD card slot and either load the project to the panel’s built-in Flash memory, re-format the SD card using the SD



---

*NOTE: In the Error Log you may find the error RTE-500 - Check Sum Error, which is defined as “Memory in the panel has been corrupted by power loss, etc.” If this is the case, try cycling power to the panel, re-transfer the project to the panel, and re-transfer the firmware, etc. in sequential steps to try to correct the problem.*

---

formatter available from [SDcard.org](http://SDcard.org), or try a different SD memory card.

## Data Not Logging Problems

If the data log is missing entries, or a Runtime Error for the Log Errors as shown in **Appendix B: HMI Runtime Errors** is seen, then check the following possible causes.

- 1) Check that the memory devices that were selected for **Data Storage** under the **C-more** programming software’s **Main Menu - Setup** drop down - **Panel Manager** dialog box are plugged into their proper locations. Alarms, messages and screen captures can be independently selected to be saved to either a USB pen drive plugged into the USB Port - Type A, or an SD card plugged into the SD Card Slot.
- 2) Ensure that the SD card has been formatted with the SD formatter provided by [SDcard.org](http://SDcard.org).
- 3) The memory device could be bad. If possible, check it by plugging it into a PC that has the ability to access the memory device. Also, not all USB devices are compatible with the **C-more** HMIs. Try using the **AutomationDirect** USB Pen Drive, p/n USB-FLASH. Check **System Screen, Memory** for the presence of the USB device inserted.

## Electrical Noise Problems

Noise is one of the most difficult problems to diagnose. Electrical noise can enter a system in many different ways which fall into one of two categories, conducted or radiated. It may be difficult to determine how the noise is entering the system, but the corrective actions for either of the types of noise problems are similar.

- Conducted noise is when the electrical interference is introduced into the system by way of an attached wire, panel connection, etc. It may enter through a power supply connection, the communication ground connection, or the chassis ground connection.
- Radiated noise is when the electrical interference is introduced into the system without a direct electrical connection, much in the same manner as radio waves.

While electrical noise cannot be eliminated, it can be reduced to a level that will not affect the system.

- **Most noise problems result from improper grounding of the system. A good earth ground can be the single most effective way to correct noise problems.** If a ground is not available, install a ground rod as close to the system as possible. Ensure all ground wires are single point grounds and are not daisy chained from one device to another. Ground metal enclosures around the system. A loose wire can act as a large antenna, introducing noise into the system. Therefore, tighten all connections in your system. Loose ground wires are more susceptible to noise than the other wires in your system. Review **Chapter 4: Installation & Wiring** if you have questions regarding how to ground the HMI.
- Electrical noise can enter the system through the power source for the HMI. Installing a properly wired isolation transformer (neutral grounded) for all AC sources can help the problem, but only if it is wired correctly. DC sources should be well-grounded good quality supplies.
- Never run communication cables or low-voltage power wiring close to high voltage wiring or pulse generating wiring that controls such devices as solenoids, servos, VFDs, etc.

## Touch Screen Not Working

The CM5-RHMI is compatible with most HID compatible Resistive and pCap touchscreens.

Check with the manufacturer of the touch screen monitor about what touch screen drivers are supported by the touch screen. See page 8-9 for a list of compatible monitors and manufacturers.

BLANK  
PAGE