

GETTING STARTED



CHAPTER

1

In This Chapter...

Introduction	1-2
The Purpose of This Manual.....	1-2
Supplemental Manuals.....	1-2
Technical Support	1-2
Conventions Used	1-3
Key Topics for Each Chapter	1-3
Product Overview	1-4
Quick Start Steps	1-5
Optional Accessories	1-5
C-more LED Status Indicators.....	1-11
CM5-RHMI Beep.....	1-12
Reset Button	1-12
RUN / STOP switch.....	1-12
User Defined LED	1-12

Introduction

The Purpose of This Manual

Thank you for purchasing our **C-more**® human-machine interface (HMI) family of products. This manual describes AutomationDirect.com's **C-more** headless HMI, its specifications, included components and available accessories and provides you with important information for installation, connectivity and setup. The manual shows you how to install, wire and use the product. It also helps you understand how to interface the HMI to other devices in a control system.

This user manual contains important information for personnel who will install the HMI and accessories and for the personnel who will be programming the HMI. If you understand control systems that make use of operating interfaces such as the **C-more** RHMI, our user manuals will provide all the information you need to get and keep your system up and running.

Supplemental Manuals

If you are familiar with industrial control type devices, you may be able to get up and running with just the aid of the Quick Start Guide that is available for download. You should also refer to the On-line help that is available in the **C-more** programming software for more information about programming the panel.

Technical Support

We strive to make our manuals the best in the industry. We rely on your feedback to let us know if we are reaching our goal. If you cannot find the solution to your particular application, or, if for any reason you need technical assistance, please call us at:

770-844-4200

Our technical support group will work with you to answer your questions. They are available Monday through Friday from 9:00 A.M. to 6:00 P.M. Eastern Time. We also encourage you to visit our web site where you can find technical and non-technical information about our products and our company.

<http://c-more.automationdirect.com>

Conventions Used



When you see the “notepad” icon in the left-hand margin, the paragraph to its immediate right will be a special note. The word **NOTE:** in boldface will mark the beginning of the text.



When you see the “exclamation mark” icon in the left-hand margin, the paragraph to its immediate right will be a warning. This information could prevent injury, loss of property, or even death (in extreme cases). The word **Warning:** will mark the beginning of the text.

Key Topics for Each Chapter

The beginning of each chapter will list the key topics that can be found in that chapter.

Getting Started	
 CHAPTER 1	
In This Chapter...	
General Information	1-2
Specifications	1-4

Product Overview

Some of the features designed into the product to provide excellent hardware and software are listed below.

- HID touch screen driver works with most pCap and Resistive touchscreen monitors
- Plenty of memory and methods to get data in/out of the panel
- Overlapping active devices onscreen
- 16.7 million colors for enhanced graphics
- HDMI Video Output supporting several resolutions including 1080p (60Hz) and Audio
- Built-in FTP client/server, E-mail client, Web server, and MQTT Client
- User-configurable LED on the front of the unit
- Built-in project simulation; test on PC while developing
- Two Ethernet 10/100 Base-T ports
- 15-pin serial port with RS-232, RS422/485
- 3-wire terminal block RS-485 port
- Program via USB or Ethernet
- Object and bitmap animation
- Thousands of built-in symbols and Windows fonts
- PID face plate, trending, alarming, and a recipe database
- Trend Data Logging
- Event Manager to trigger actions based on assigned state changes, schedules, PLC tag names, set up in a database environment, trigger a sound byte, initiate a screen capture, send a data file (FTP), send an E-mail, etc.
- Internet Remote Access
- Network time server/client
- JPEG and JPG graphic object support (to reduce project size)
- 4 USB Type A ports for data logging, project transfer, audio adapter, mouse, and other HID compatible devices

Quick Start Steps

Step 1 – Unpack and Inspect

a.) Unpack the **C-more** RHMI from its shipping carton.



b.) Unpack any accessories that have been ordered, such as programming cable, communications cable, etc.

c.) Inspect all equipment for completeness. If anything is missing or damaged, immediately call the AutomationDirect® returns department @ 1-800-633-0405.

Optional Accessories

SD Memory Card
EA-SD-CARD



USB Pen Drive
USB-FLASH



DSUB Port Adapter
EA-COMCON-3A



Step 2 – Install Optional Hardware Accessories

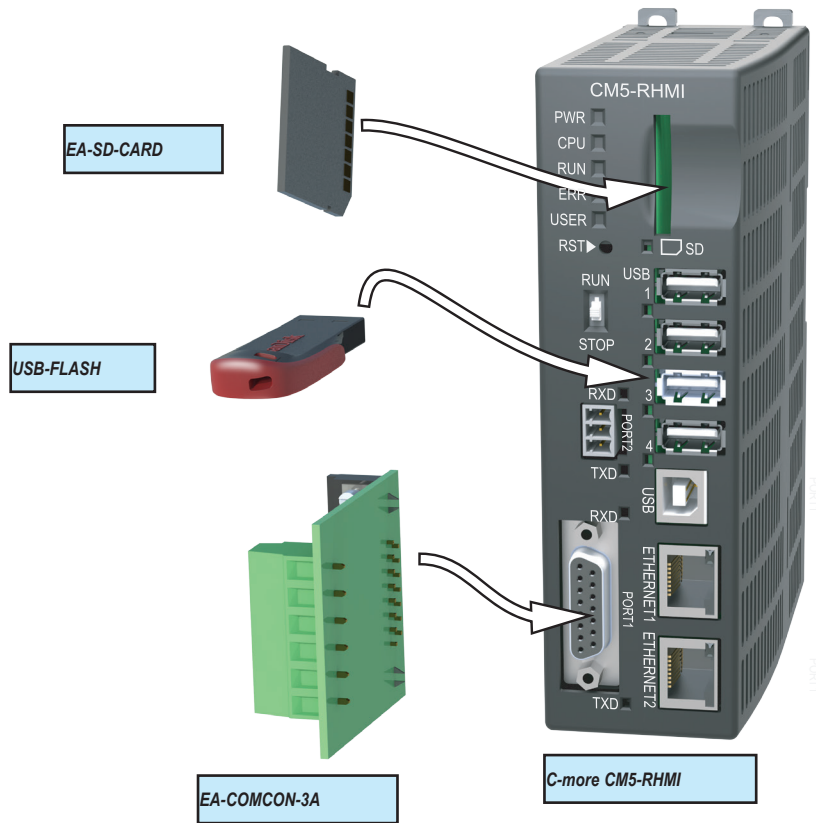

Step 3 – Become Familiar with Available Communication Ports

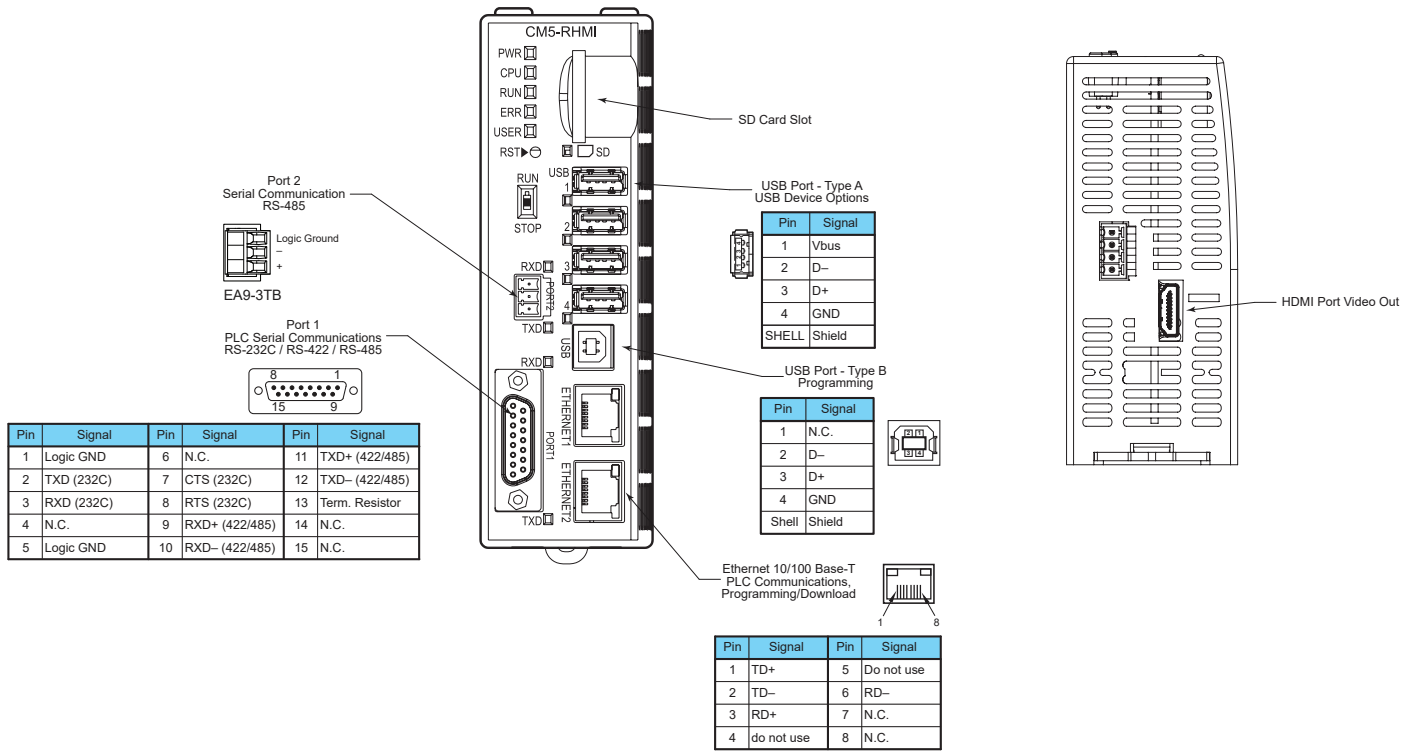

NOTE: See Chapter 6: PLC Communications for additional details on the available communication ports, protocols and cables.

Step 4 – Install the Programming Software and Develop a Project

Download the latest version of the **C-more** Programming Software, p/n CM5-PGMSW, from the Automationdirect website. Alternately, if the **C-more** Programming Software USB is available, you may install from the software USB. Refer to the AutomationDirect website for current minimum system requirements for installation.

For software download installation, follow the screen prompts to download and install the **C-more** Programming Software.

For USB installation, insert the supplied USB into the PC's USB port and navigate to the USB drive location on the PC. Double-click on *EA_Setup.exe* and follow the instructions. If you need assistance during the software installation, call the AutomationDirect Technical Support team @ 770-844-4200.



NOTES: Regarding Ethernet access to a C-more panel.

If you intend to take advantage of the methods of remote access to the panel, including the web server, PC remote access, FTP, iOS or Android app, you need to consider the security exposure in order to minimize the risks to your process and your C-more panel.

Security measures may include password protection, changing the ports exposed on your network, including a VPN in your network, and other methods. Security should always be carefully evaluated for each installation. Refer to Appendix C - Security Considerations for Control Systems Networks.

Step 5 – Connect HMI to Computer

- Connect a USB Programming Cable, such as p/n USB-CBL-AB15, from a USB type A port on the PC to the USB type B programming port on the **C-more** HMI.
- Or connect the **C-more** CM5-RHMI and PC together either directly or via an Ethernet switch and CAT5 Ethernet cables

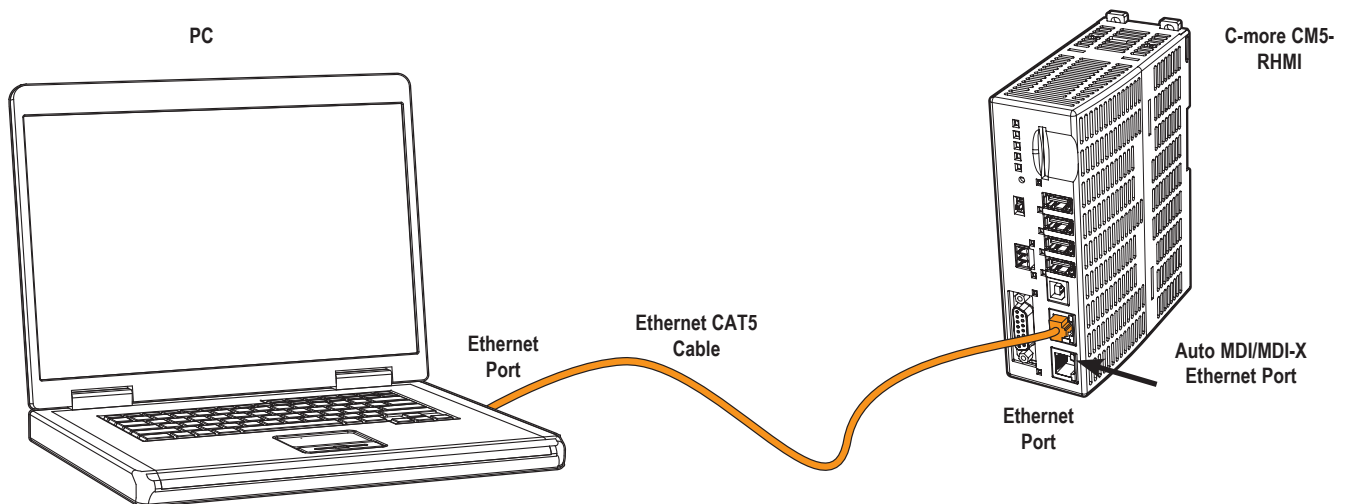
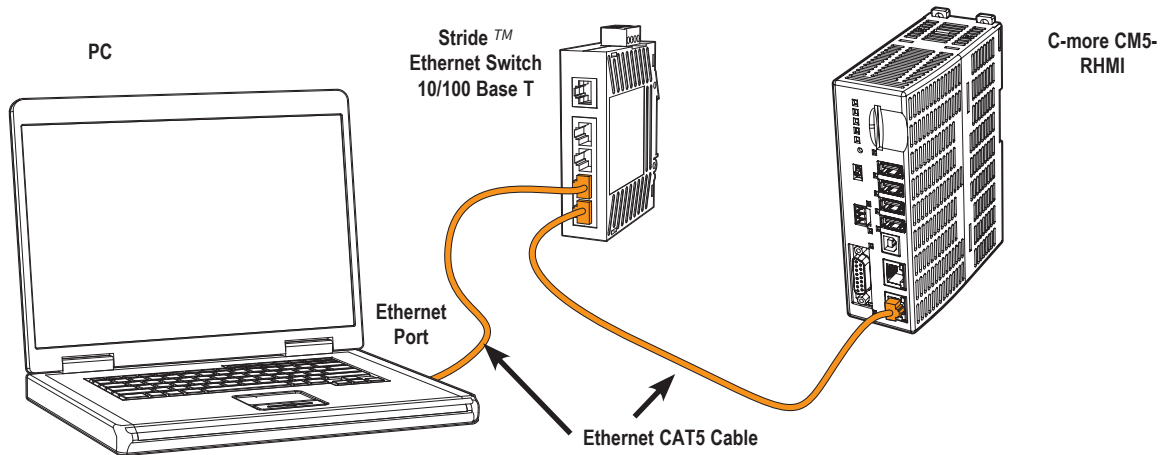
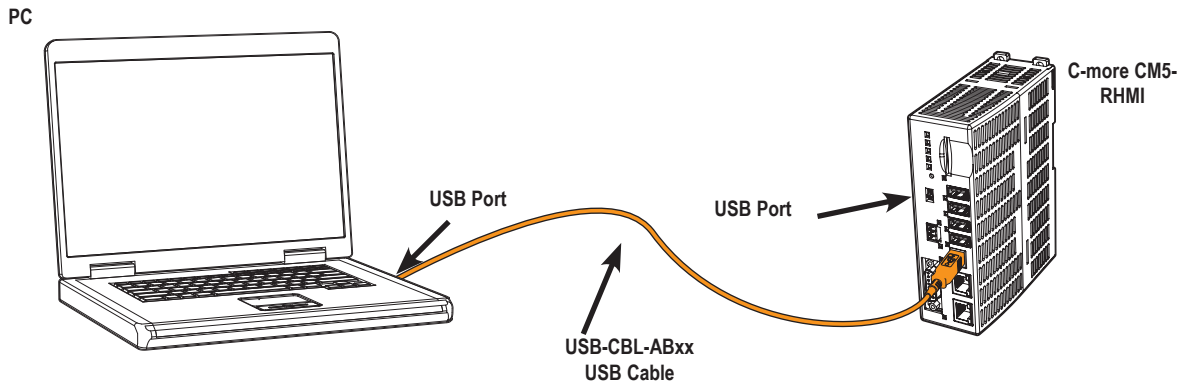

Step 6 – Provide Power to the HMI

- **Connect a dedicated** 12-24 VDC Class 2 power supply to the DC connector on the front of the **C-more** CM5-RHMI. Make sure to connect the ground terminal to a proper equipment ground.
- **Then** turn on the power source and check the LED status indicators on the front of the **C-more** CM5-RHMI for proper indication (see next page).



NOTE: A dedicated power supply is recommended. If the power supply also feeds inductive loads such as solenoids or relays, the transients caused by these loads can affect the operation of or cause damage to HMI components.

DC Power Wiring

Recommended Fuse	
Rating	ADC part number
5 A	MDL-5

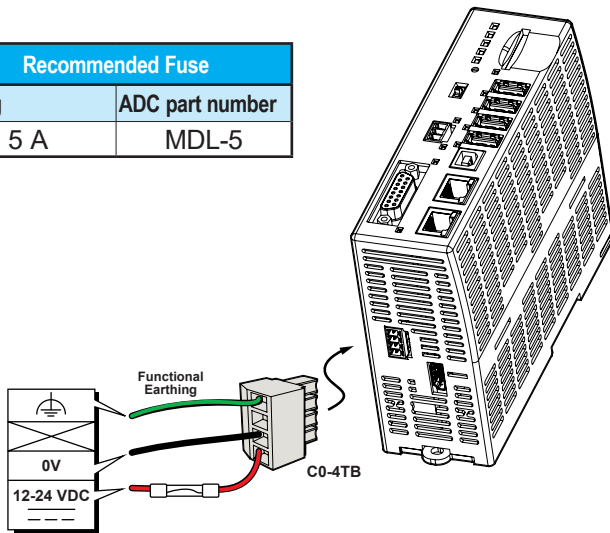

Tightening Torque	
Power supply cable torque	35 oz-in (0.25 Nm)



Warning: Use 60/75°C copper conductors only.

Step 6 – Provide Power to the HMI (cont'd)

C-more LED Status Indicators

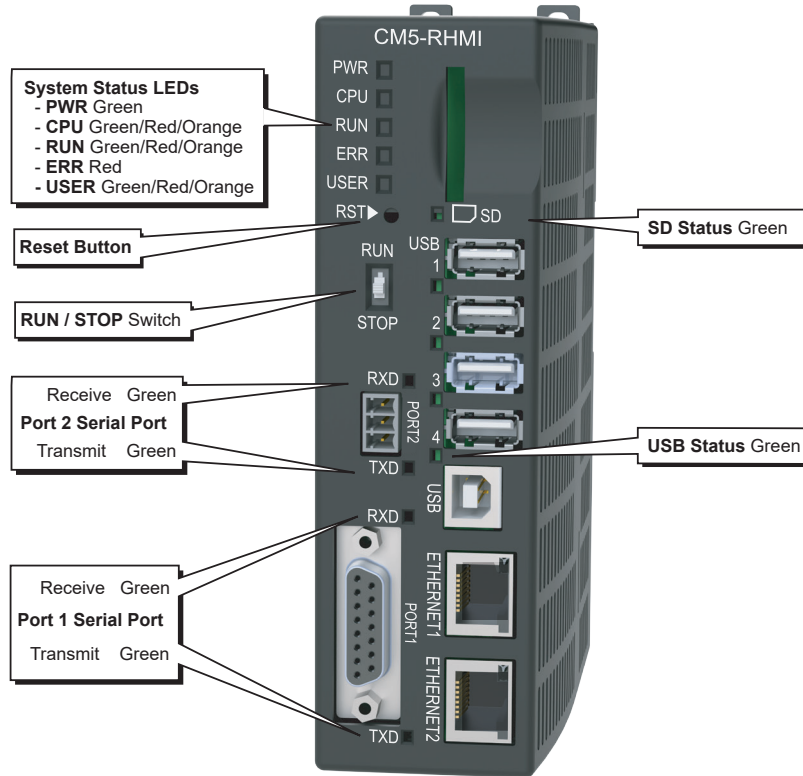

System Status LEDs				
	LED	CPU	RUN	ERR
State	Loading Project	–	Blinking Green (0.2s)	–
	Loading OS	Blinking Green (0.5s)	–	OFF
	CPU Running Normally	Green	–	OFF
	Project Loaded and Running	–	Green	–
	No User Project	–	Orange	–
	Reset to Factory Default	Blinking Green (0.5s)	Blinking Green (0.5s)	Blinking Red (0.5s)
	System Screen	–	OFF	–
	Password Required	–	Blinking Orange (0.5s)	Blinking Red (0.5s)
	Errors	Power Loss Detection	Blinking Orange (0.2s)	–
Memory Error		Red	OFF	Red
OS Error		Blinking Orange (0.5s)	OFF	Red
No Log Storage Found		–	Blinking Orange (0.5s)	Blinking Red (0.5s)
General Error*		–	Red	Blinking Red (0.5s)
Warning*		–	Blinking Orange (0.5s)	Blinking Red (0.5s)
Safe Mode		Orange	OFF	Red

*Note - See Chapter 8 – Troubleshooting for General Error and Warning explanations.

CM5-RHMI Beep

Beep Functions

Function	Beep Pattern
Boot	1-long, 2-short
Boot Error*	3-long
HDMI Connected	3-short
Reset to Factory Defaults	14 short beeps progressively closer together followed by 1-long beep.
Blink Screen	5-long
*Boot Errors Multiple Projects Write Protected SD Card No Log Storage Found Password Protected	

Reset Button

Reset Button

Push Action	Behavior	Note
Push for <15 seconds	Reboot the CM5-RHMI	
Push for >15 seconds	Reset to factory default	The project is cleared and all settings are initialized.
While holding down the reset button, power on the CM5-RHMI and continue holding the button for >15 seconds	Safe mode	The CPU LED will blink ORANGE. See “No System Found” in Chapter 8 - Troubleshooting

RUN / STOP switch

RUN / STOP Switch

Position	Behavior	Note
RUN	Project will run if present and the RUN LED will be green	If no project is loaded in the HMI, the message “No User Program” will be displayed on a connected display. The RUN LED will be orange.
STOP	The project and any logging stops and the System Screen is displayed.	If a password has been set up for the System Screen, the RUN LED will blink orange.
Power on the CM5-RHMI while in the STOP position	The System Screen is displayed	A System Screen password is ignored.

User Defined LED

The user defined LED on the CM5-RHMI can be controlled from the project to illuminate red, green or orange. It can also be configured to blink these colors. Refer to the online help file provided with the programming software for details.

Step 7 – Access the CM5-RHMI Setup Screens

- Access the Main Menu of the CM5-RHMI System Setup Screens by changing the selector switch on the front of the unit to STOP.
- Adjust the time and date for the panel by pressing the Setting button on the Main Menu. Then press the Adjust Clock button on the Setting screen.
- Use the right-pointing arrows for the time or date display to select the unit to change. Use the up and down arrows to increment or decrement the value for the selected unit.
- Press OK when done to accept the changes to the time and date in the HMI or press Cancel to exit the Adjust Clock setup screen without making any changes.
- Press the Main Menu button on the Setting screen and then the Exit button on the Main Menu screen to return to the application screen.
- Change the selector switch on the front of the unit to RUN.

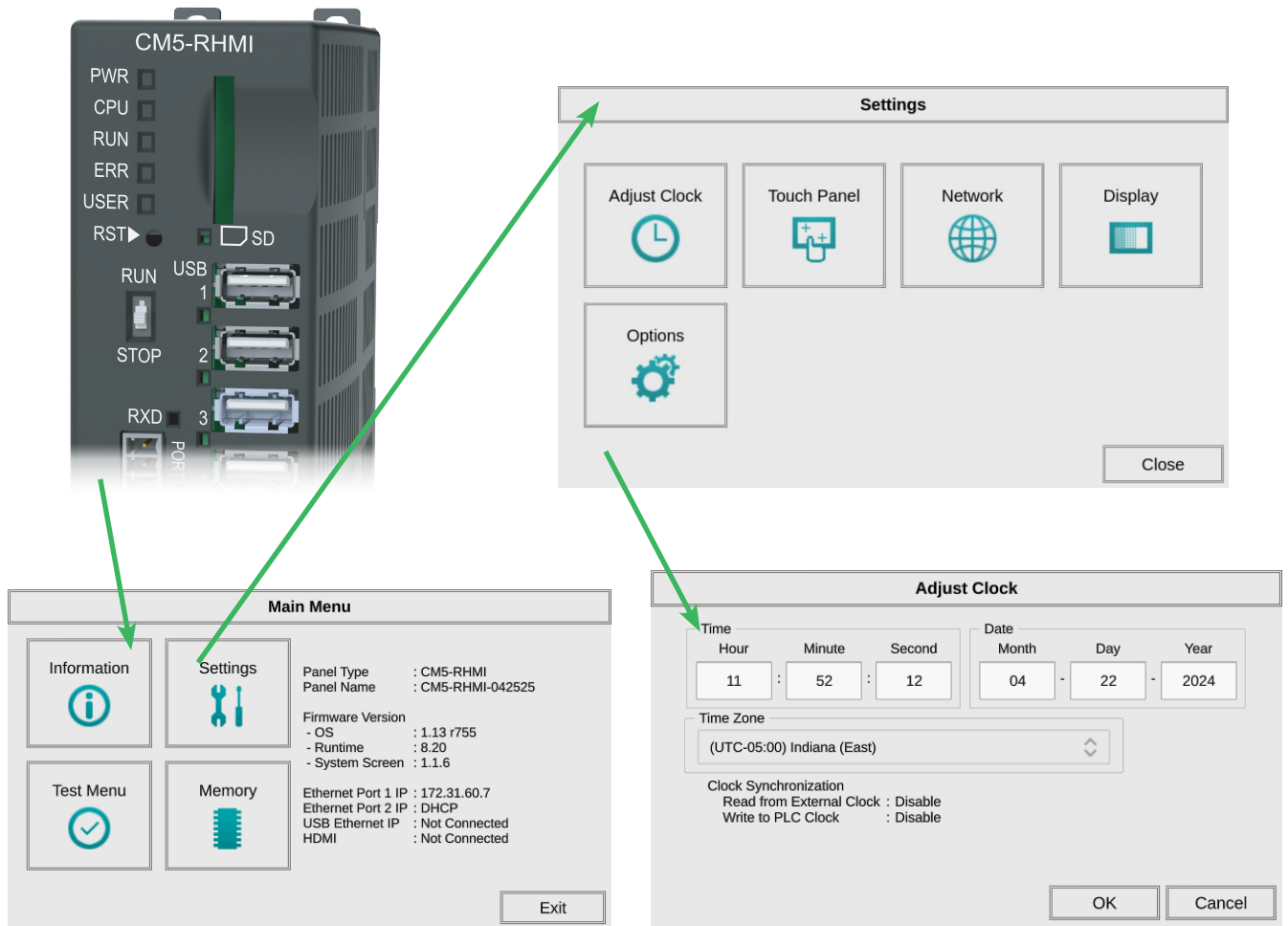

NOTE: For more information on CM5-RHMI setup screens, see Chapter 5 - System Setup Screens.

Step 8 – Choose HMI to Device Cable

The table below shows the PLCs, controllers and protocols supported by the CM5-RHMI. Ensure your controller and protocol are supported.

PLC Protocol Table

Model		Protocols	
AutomationDirect	Productivity Series	Productivity Serial Productivity Ethernet	
	Do-more (BRX)	All Do-more Serial Do-more Ethernet	
	CLICK	All	CLICK Serial
		C0-1x series	CLICK Ethernet
	CLICK PLUS	C2-01CPU-x, C2-03CPU-x, All with C2-DCM	CLICK Serial
		All	CLICK Ethernet
	DL05/DL06	all	K-Sequence Direct NET Modbus (Koyo addressing)
		H0-ECOM/H0-ECOM100	Direct LOGIC Ethernet
	DL105	all	K-Sequence
	DL205	D2-230	K-Sequence
		D2-240	K-Sequence Direct NET
		D2-250/D2-250-1/D2-260/D2-262	K-Sequence
			Direct NET Modbus (Koyo addressing)
		D2-240/D2-250-1/D2-260 Using DCM	Direct NET Modbus (Koyo addressing)
		H2-ECOM/H2-ECOM100	Direct LOGIC Ethernet
	DL305	D3-330/330P (Requires the use of a Data Communications Unit)	Direct NET
		D3-340	Direct NET
		D3-350	K-Sequence Direct NET Modbus (Koyo addressing)
			Direct NET Modbus (Koyo addressing)
		D3-350 DCM	Direct NET Modbus (Koyo addressing)
	DL405	D4-430	K-Sequence Direct NET
		D4-440	K-Sequence Direct NET
		D4-450/D4-454	K-Sequence
			Direct NET Modbus (Koyo addressing)
		All with DCM	Direct NET Modbus (Koyo addressing)
		H4-ECOM/H4-ECOM100	Direct LOGIC Ethernet
	H2-WinPLC (Think & Do) Live V5.2 or later and Studio any version		Think & Do Modbus RTU (serial port)
	H2-WinPLC (Think & Do) Live V5.5.1 or later and Studio V7.2.1 or later		Think & Do Modbus TCP/IP (Ethernet port)
GS Drives		GS Drives Serial	
		GS Drives TCP/IP (GS-EDRV)	
SOLO Temperature Controllers (models with serial communications)		SOLO Temperature Controller	

Step 8 – Choose HMI to Device Cable (cont'd)

PLC Protocol Table (cont'd)		
Model		Protocols
	MicroLogix 1000, 1100, 1200, 1400 and 1500	DF1 Half Duplex; DF1 Full Duplex
	SLC 5-03/04/05	
	ControlLogix™, CompactLogix™, FlexLogix™	DF1 Full Duplex
	PLC-5	
	ControlLogix, CompactLogix, FlexLogix - Tag Based	DF1 Half Duplex; DF1 Full Duplex
	ControlLogix, CompactLogix, FlexLogix - Generic I/O Messaging	EtherNet/IP Server
	ControlLogix, CompactLogix, FlexLogix - Tag Based	EtherNet/IP Client
	MicroLogix 1100, 1400 and SLC 5/05, via native Ethernet port	
	MicroLogix 1000, 1100, 1200, 1400, 1500, SLC 5-03/04/05, all via ENI adapter	
	Micro 800 Series	Modbus RTU
Modbus TCP		
Micro 800 Series - Tag Based	DF1 Full Duplex	
	EtherNet/IP Client	
Modbus RTU	Modbus RTU devices	Modbus RTU
Modbus TCP/IP	Modbus TCP/IP devices	Modbus TCP/IP
GE	90/30, 90/70, Micro 90, VersaMax Micro	SNPX
	90/30, Rx3i	S RTP Ethernet
Mitsubishi	FX Series	FX Direct
	Q02, Q02H, Q06H, Q12H, Q25H	Q CPU
	Q, QnA Serial	QnA Serial
	Q, QnA Ethernet	QnA Ethernet
Modicon	984 CPU, Quantum 113 CPU, AEG Modicon Micro Series 110 CPU: 311-xx, 411-xx, 512-xx, 612-xx	Modbus RTU
	Other devices using Modicon Modbus addressing	Modbus RTU TUModbus TCP/IP
Omron	C200 Adapter, C500	Host Link
	CJ1/CS1 Serial	FINS
	CJ1/CS1 Ethernet	
Siemens	S7-200 CPU, RS-485 Serial	PPI
	S7-200 CPU, S7-300 CPU, S7-400, S7-1200 CPU Ethernet	Ethernet ISO over TCP

Step 9 – Connect HMI to PLC

- Connect the serial communications cable between the **C-more** CM5-RHMI and the PLC
- **Or** connect the **C-more** CM5-RHMI and PLC together either directly or via an Ethernet switch and CAT5 Ethernet cables.

For further information on setting up communications between the CM5-RHMI and a PLC, see the **C-more** programming help file topic *CM129: Creating a New Project*.

Cable Description	Cable Part Number
Communication cable, 15-pin D-shell male to 6-pin RJ12, 9.8ft/3m cable length. For use with C-more or C-more Micro panel and AutomationDirect PLCs with RJ12 ports.	EA-2CBL
Communication cable, 15-pin D-shell male to 15-pin D-sub HD15 male, 3m/9.8ft cable length. For use with C-more or C-more Micro panel and a DL06, D2-250(-1), D2-260 or D2-262 (bottom port) CPU.	EA-2CBL-1
Communication cable, 15-pin D-shell male to 6-pin RJ11, 3m/9.8ft cable length. For use with C-more or C-more Micro panel and a D3-340 CPU top or bottom port.	EA-3CBL
Communication cable, 15-pin D-shell male to 15-pin D-shell male, 3m/9.8ft cable length. For use with C-more or C-more Micro panel and a DL405 (top port) CPU.	EA-4CBL-1
Communication cable, 15-pin D-shell male to 25-pin D-shell male, 3m/9.8ft cable length. For use with C-more or C-more Micro panel and a D2-DCM, D3-232-DCU, D3-350 (bottom port) or DL405 (bottom port) CPU.	EA-4CBL-2
Communication cable, 15-pin D-shell male to 8-pin mini DIN male, 3m/9.8ft cable length. For use with C-more or C-more Micro panel and an Allen-Bradley Micrologix CPU.	EA-MLOGIX-CBL
Communication cable, 15-pin D-shell male to 9-pin D-shell female, 3m/9.8ft cable length. For use with C-more or C-more Micro panel and an Allen-Bradley SLC 5/03, 5/04 or 5/05 CPU with DF-1 port.	EA-SLC-232-CBL
Communication cable, 15-pin D-shell male to 25-pin D-shell male, 3m/9.8ft cable length. For use with C-more or C-more Micro panel and an Allen-Bradley PLC-5 CPU with a DF1 port.	EA-PLC5-232-CBL
Communication cable, 15-pin D-shell male to 15-pin D-shell male, 3m/9.8ft cable length. For use with C-more or C-more Micro and GE Fanuc Series 90/30 or 90/70 serial port.	EA-90-30-CBL
Communication cable, 15-pin D-shell male to 25-pin D-shell male, 3m/9.8ft cable length. For use with C-more or C-more Micro panel and a Mitsubishi FX Series CPU.	EA-MITSU-CBL
Communication cable, 15-pin D-shell male to 8-pin mini DIN male, 3m/9.8ft cable length. For use with C-more or C-more Micro panel and a Mitsubishi FX Series CPU.	EA-MITSU-CBL-1
Communication cable, 15-pin D-shell male to 25-pin D-shell male, 3m/9.8ft cable length. For use with C-more or C-more Micro panel and an Omron C200 or C500 CPU.	EA-OMRON-CBL



NOTE: The above list of pre-made communications cables may be purchased. See Chapter 6: PLC Communications for wiring diagrams of additional user constructed cables. Chapter 6 also includes wiring diagrams for the pre-made cables.

EA-2CBL

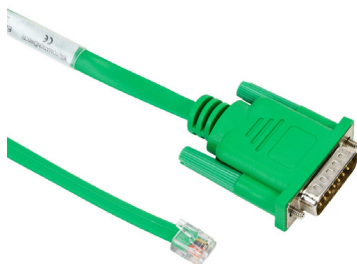

EA-2CBL-1

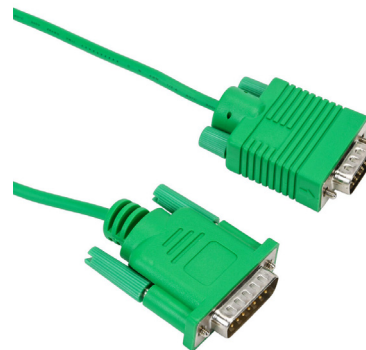

Serial

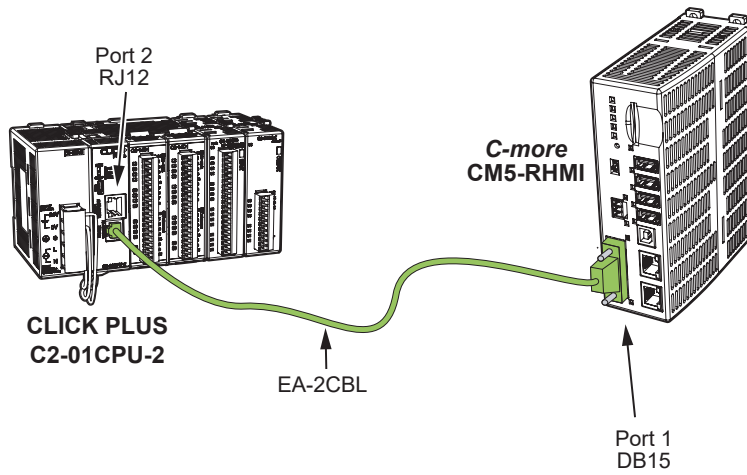

Ethernet via Switch

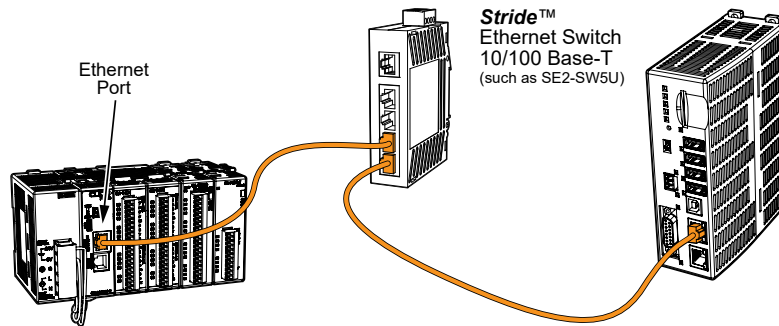

Ethernet

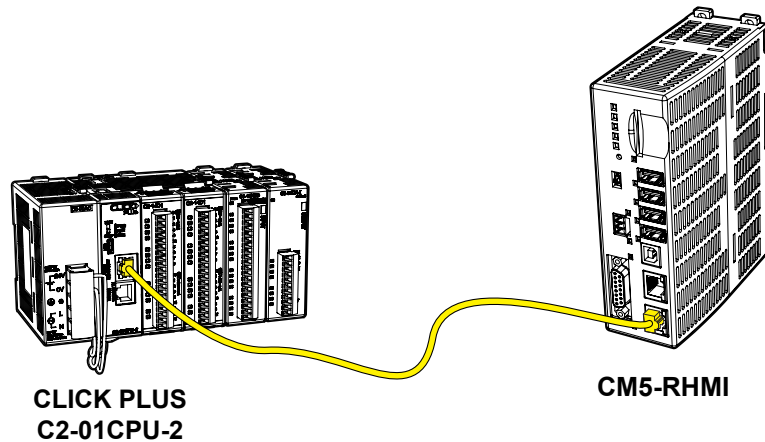

BLANK
PAGE