

PLC COMMUNICATIONS



In This Chapter...

Introduction.....	4-2
PLC Communication Ports Specifications	4-3
LED Status Indicators.....	4-4
Remote PLC App Configuration and Use	4-6
C2-DCM Intelligent Module Communication Ports Specifications.....	4-7
3 Steps to Using the CLICK PLC Communications	4-8
Typical Communication Applications	4-9
W-1: USB Port Wiring	4-13
W-2: Com Port 2 (RS-232) Wiring	4-14
W-3: Com Port 1 (Ethernet) Wiring.....	4-18
W-4: Com Port 3 Wiring.....	4-20
W-5: C2-DCM Com Port RS-232 Wiring	4-21
W-6: C2-DCM Com Port RS-485 Wiring	4-22
C-1: USB Port Setup.....	4-23
C-2: Com Port 1 (Ethernet) Setup	4-24
C-3: Wireless LAN (WLAN) Setup.....	4-25
C-4: Bluetooth Setup	4-26
C-5: Com Port 2 Setup (Modbus RTU).....	4-27
C-6: Com Port 2 Setup (ASCII)	4-28
C-7: Com Port 3 Setup (Modbus RTU).....	4-29
C-8: Com Port 3 Setup (ASCII)	4-30
C-9: C2-DCM Com Port 1 or 2 Setup (ASCII)	4-31
C-10: C2-DCM Com Port 1 or 2 Setup (Modbus RTU)	4-32
P-1: Modbus Slave (Server) Programming.....	4-33
P-2: Modbus Master Programming (Modbus RTU).....	4-37
P-3: Modbus Client (Modbus TCP) Programming	4-42
P-4: ASCII Receive Programming.....	4-48
P-5: ASCII Send Programming	4-51

Introduction

This chapter explains the communications ability of the CLICK PLUS PLC system for exchanging data between the PLC unit and other connected serial devices. It covers:

- Electrical connections used for communications
- Networking routing between the PLC and other devices,
- Setting the port communication parameters,
- Selecting the protocols and the available data addressing types to use, and
- Ladder logic program instructions that make it all work together.

All CLICK PLUS PLCs have a built-in microB USB port for programming.

The C2-01CPU and C2-03CPU have an RS-232 port, designated Port 2. The port uses a 6-pin RJ12 phone type jack. It is a general purpose port, user configurable, with its communication parameters within CLICK Programming Software, C0-PGMSW. Port 2 can be used as a Modbus RTU master or slave protocol device, or handle ASCII data In or Out (ASCII stands for American Standard Code for Information Interchange and defines a character encoding method for text that is used in computers and other communication devices. Details can be found by doing a search for ASCII on the internet).

The C2-03CPU also has a 3-pin RS-485 port, designated Port 3. Like Port 2, Port 3 is a general purpose port with its communication parameters being user configurable from the programming software. Port 3 can be used as a Modbus RTU master or slave protocol device, or handle ASCII data In or Out.

The C2-01CPU and C2-03CPU have a built-in Ethernet communications port.

The C2-02CPU and C2-03CPU have an antenna port capable of both Bluetooth and WLAN communications.

The CLICK PLUS PLCs can be networked to other CLICK PLCs, data input devices (barcode readers, weight scales, etc.), and/or data output devices (serial printers, serial text displays, etc.). It is also possible to network the CLICK PLUS PLC to other 3rd party PLCs and devices that have the ability to communicate using the Modbus RTU and TCP protocols.

The final part of the PLC Communications chapter contains explanations and examples of the various ways the Send and Receive programming instructions can be used to perform Modbus RTU protocol and ASCII data communications between devices.

There are three different data addressing types that can be selected when using the Modbus RTU protocol from the Send and Receive instructions. They are, CLICK addressing, Modbus 984 addressing, or Modbus HEX addressing. The CLICK addressing makes it convenient to exchange data between CLICK PLCs. The other addressing choices are selected based on the Modbus protocol addressing the networked devices are using. For details on the Modbus protocol, visit www.modbus.org.

NOTE: *The Modbus RTU Master is identified as the device that controls the exchange of data between itself and any connected slave device. There can only be one master on the network. When the CLICK PLC is the master, it is easily identified. It will be the PLC in the network with the Send and/or Receive instructions using the Modbus protocol in its ladder logic program.*



PLC Communication Ports Specifications

The CLICK PLUS PLC units have several built-in communications ports, as shown below.

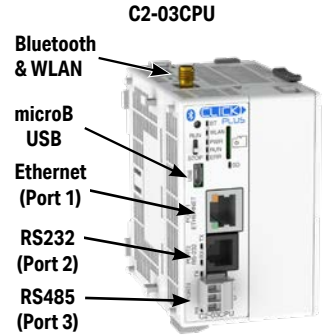
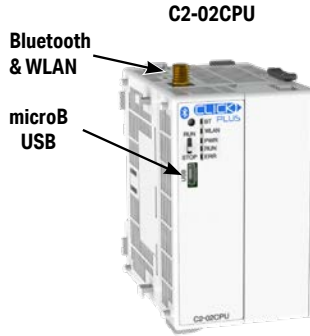
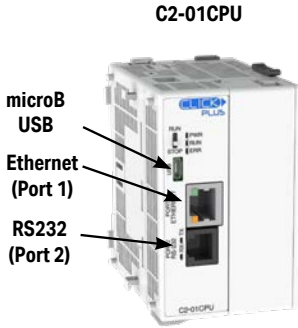

Com Port 1 Specifications	
Use: Programming and Ethernet Communication	
Physical: 8 pin, RJ45, Ethernet	
Communication Speed (Mbps): 10/100	
Protocol: Modbus TCP (client/server), EtherNet/IP Implicit and Explicit (adapter server), DNS, DHCP, NTP, MQTT	

Com Port 2 Specifications	Default
Use: Serial Communication	-
Physical: 6 pin, RJ12, RS-232	-
Communication speed (baud): 2400, 4800, 9600, 19200, 38400, 57600, 115200	38400
Parity: odd, even, none	Odd
Station Address: 1 to 247	1
Data length: 8 bits (Modbus RTU) or 7, 8 bits (ASCII)	8 bits
Stop bit: 1,2	1
Protocol: Modbus RTU (master/slave) or ASCII in/out	Modbus RTU

Com Port 3 Specifications	Default
Use: Serial Communication	-
Physical: 3 pin, RS-485	-
Communication speed (baud): 2400, 4800, 9600, 19200, 38400, 57600, 115200	38400
Parity: odd, even, none	Odd
Station Address: 1 to 247	1
Data length: 8 bits (Modbus RTU) or 7, 8 bits (ASCII)	8 bits
Stop bit: 1,2	1
Protocol: Modbus RTU (master/slave) or ASCII in/out	Modbus RTU

Port 1
8 pin RJ45 Phone Type Jack

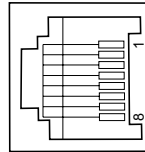

Port 1 Pin Descriptions		
1	TX+	Transmit Data (+)
2	TX-	Transmit Data (-)
3	RX+	Receive Data (+)
4	NC	Not connected
5	NC	Not connected
6	RX-	Receive Data (-)
7	NC	Not connected
8	NC	Not connected

Port 2
6 pin RJ12 Phone Type Jack

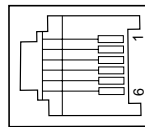

Port 2 Pin Descriptions		
1	0V	Power (-) connection (GND)
2	5V	Power (+) connection
3	RXD	Receive data (RS-232)
4	TXD	Transmit data (RS-232)
5	RTS	Request to send
6	0V	Power (-) connection (GND)

Port 3
3 Pin Terminal Block

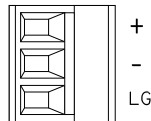

Port 3 Pin Descriptions		
1	+ (plus)	Signal A (RS-485)
2	- (minus)	Signal B (RS-485)
3	LG	Logic Ground(0V)

See Chapter 2: *Specifications* for the microB USB port and antenna port specifications.

LED Status Indicators

POWER LED (Green)	
On	Power Good
Blink	USB Low Power Mode
Off	Power Failure

RUN LED (Green)	
On	CPU Run Mode
Blink	Initializing Modules
Off	CPU Program Mode

ERROR LED (RED)	
On	Self Diagnostic Error
Blink	Self Diagnostic Warning
Off	No Error

LNK/ACT LED (Green)	
On	Connected to the network
Blink	Communicating
Off	Disconnected from the network

100MBIT LED (Orange)	
On	Communicating at 100Mbps
Off	Communicating at 10Mbps or disconnected from the network

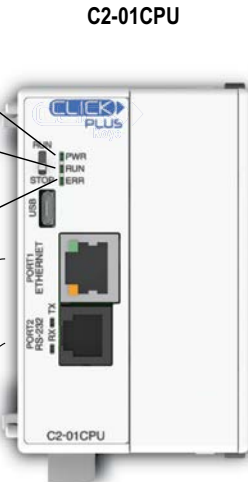

TX & RX LED (Green)	
On	Com Port Data Active
Off	No Communication

WLAN LED (Green)	
On	Link
Blink	Activity
Off	No Link

POWER LED (Green)	
On	Power Good
Blink	USB Low Power Mode
Off	Power Failure

RUN LED (Green)	
On	CPU Run Mode
Blink	Initializing Modules
Off	CPU Program Mode

ERROR LED (RED)	
On	Self Diagnostic Error
Blink	Self Diagnostic Warning
Off	No Error

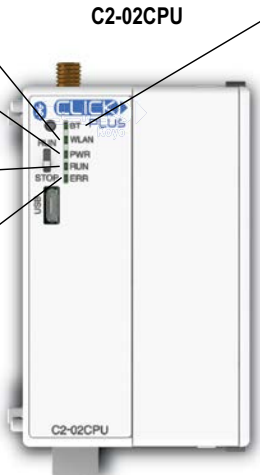

BLUETOOTH LED (Blue)	
On	Link
Blink	Activity (per packet)
Blink	Pairing Mode (500ms flash)
Blink	Disabled in PLC* (200ms flash)
Off	No Link

*Error - Bluetooth disabled in PLC (SC60) is On. Pairing mode disabled.

LED Status Indicators (continued)

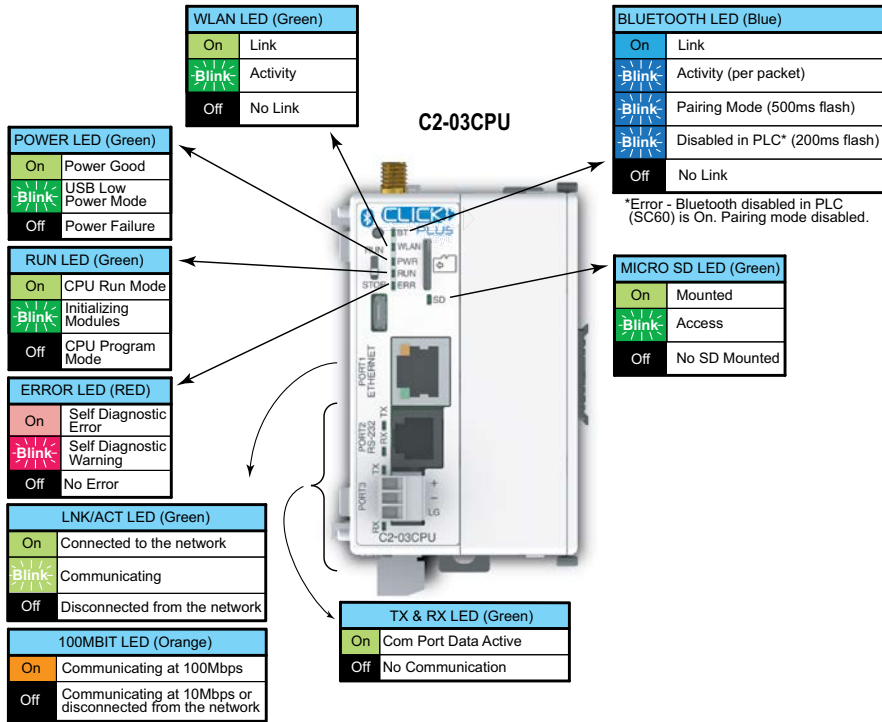

DirectLogic Devices That Do Not Work With CLICK PLCs

The CLICK PLUS PLC does not support K-sequence protocol, so the following DirectLogic devices do not work with the CLICK PLUS PLC:



D2-HPP



D4-HPP-1



DV-1000

Remote PLC App Configuration and Use

The following CLICK PLCs support the iOS and Android Remote PLC App:

- C0-10xxx-x
- C0-11xxx-x
- C0-12xxx-x
- C2-01CPU(-2)
- C2-02CPU(-2)
- C2-03CPU(-2)



The CLICK Remote PLC capability is new in Version 3.60 of the CLICK software and firmware. It enables a user to access data registers and PLC status information using a mobile phone or tablet running either iOS or Android. This enables the user to perform machine troubleshooting and setup operations when access to the programming PC can be awkward or inconvenient.

CLICK Remote PLC app is not intended to replace an operator interface for standard machine operations; instead it provides an additional tool to simplify troubleshooting and configuration of your system.

1. To use Remote PLC, you must either:
 - a. Connect your PLC to a network with a Wi-Fi access point.-OR-
 - b. Enable Bluetooth on your C2-02CPU or C2-03CPU.
2. Configure a Data Monitor with the Addresses you wish to monitor and user security.

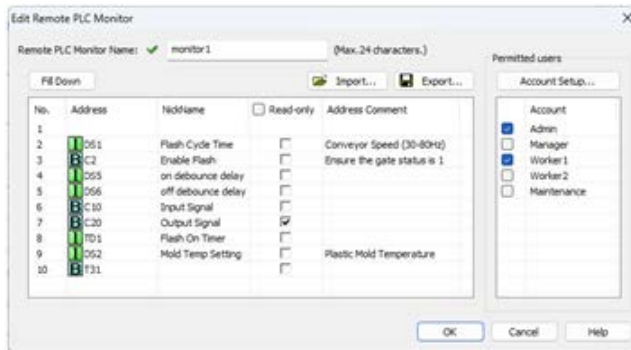

3. Set up users with access to up to 32 data monitors.
4. Download the Remote PLC App for your mobile device:

Apple App Store



Google Play (Android)



C2-DCM Intelligent Module Communication Ports Specifications

The C2-DCM Option Slot module has two serial communications ports, as shown below.

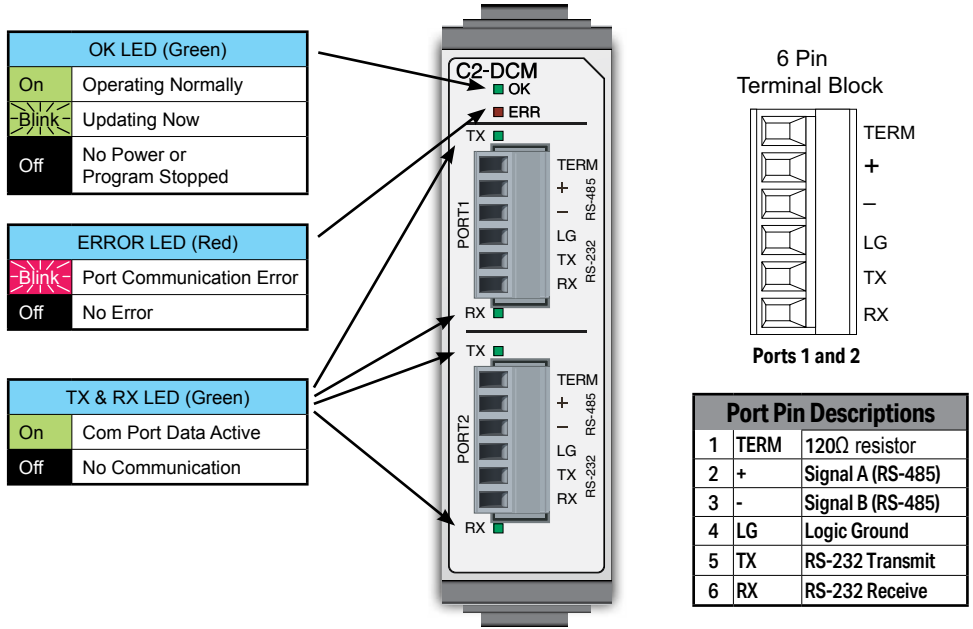

Port Specifications	
Number of Ports	2
Port Types	RS-232, RS-485 (2-wire)
Supported Protocols	Modbus RTU, ASCII (user-defined)
Communications Parameters	<ul style="list-style-type: none"> Baud rate: 2400, 4800, 9600, 19200, 38400, 57600, 115.2k bps Data bit: 7 bits, 8 bits Parity: None, Odd, Even Stop bit: 1 bit, 2 bits Flow Control: None
RS-485 Terminating Resistor	120Ω, Internal
Status Indicator LEDs	OK, ERR, TX (per port), RX (per port)

Terminal Block Specifications	
Connector Type	Pluggable Terminal Block
Number of Pins	6 (x2 terminal blocks)
Pitch	3.50 mm
Wire Size Range	16–28 AWG
Stripping Length	7.0 mm
Wire Specification	Lead-free, heat resistant, polyvinyl chloride insulated copper wire, rated over 80°C
Screw Thread	M2.0
Tightening Torque	2.0 – 2.2 lb-inch [0.22 – 0.25 N·m]
Recommended Cable	Shielded cable (AutomationDirect Q8105-1 or Q8302-1 recommended)

3 Steps to Using the CLICK PLC Communications

We offer an easy 3-step method for using the communication features of the CLICK PLC.

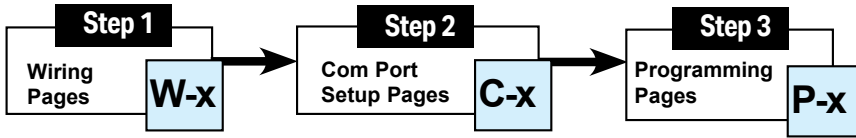

The following pages show the devices that you may connect to the CLICK PLC Com ports. Use the table below to locate information on communications for your particular application. As you can see in the table, each step has subcategories. For each step, find the subcategory description that best describes your application. Use the subcategory references (W-x, C-x, and P-x.) to find more information on these topics in this chapter. See the example below.

CLICK PLC Communications			
Step	Subcategory Reference	Subcategory Description	Page
Step 1 Wiring	W-1	USB	4-12
	W-2	Com port 2 (RS-232)	4-13
	W-3	Com port 1 (Ethernet)	4-17
	W-4	Com port 3 (RS-485)	4-19
	W-5	C2-DCM Port 1 or 2 (RS-232)	4-20
	W-6	C2-DCM Port 1 or 2 (RS-485)	4-21
Step 2 Com Port Setup	C-1	USB setup	4-22
	C-2	Com port 1 (Ethernet) setup	4-23
	C-3	WLAN setup	4-24
	C-4	Bluetooth setup	4-25
	C-5	Com port 2 setup (Modbus RTU)	4-26
	C-6	Com port 2 setup (ASCII)	4-27
	C-7	Com port 3 setup (Modbus RTU)	4-28
	C-8	Com port 3 setup (ASCII)	4-29
	C-9	C2-DCM Port 1 or 2 setup (RS-232)	4-30
	C-10	C2-DCM Port 1 or 2 setup (RS-485)	4-31
Step 3 Programming	P-1	Modbus Slave (Server) programming	4-32
	P-2	Modbus Master programming (Modbus RTU)	4-36
	P-3	Modbus Client programming (Modbus TCP)	4-41
	P-4	ASCII Receive programming	4-47
	P-5	ASCII Send programming	4-50

Example:

To connect a barcode reader that sends ASCII data to Com Port 2:



Typical Communication Applications

The diagrams on the following four pages illustrate the typical uses for the CLICK PLUS PLC's communication ports. Typical serial communication applications are continued on the next three pages.

Port 2 (RS-232) – Modbus RTU Slave Mode Only

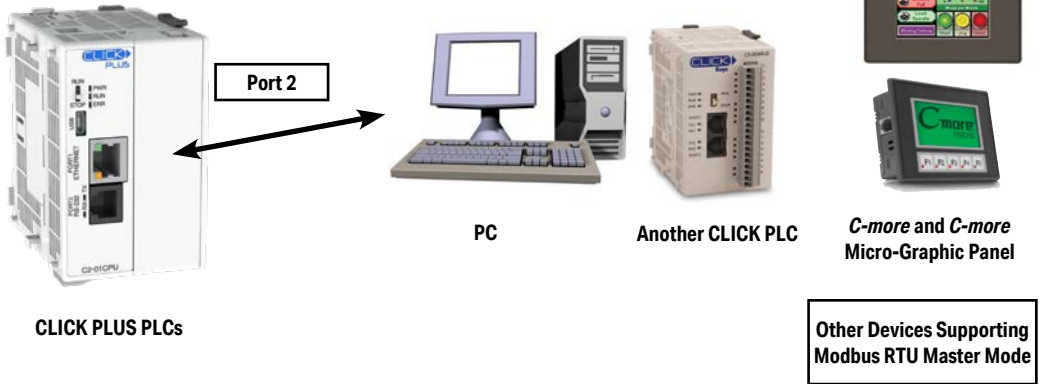

W-2 **C-5** **P-1**



TIP: C-more Micro-Graphic panels (monochrome models only) can get 5VDC power from RS-232 Port.

C-more Micro-Graphic Panel (Monochrome models only)

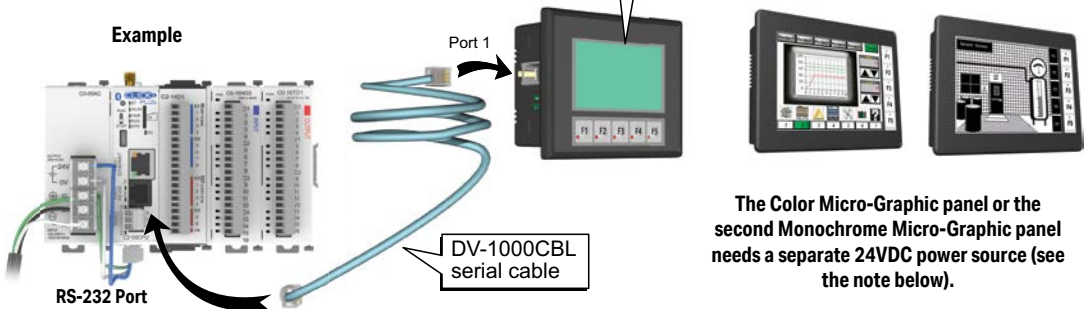

NOTE: CLICK's RS-232 port can provide 5VDC to power one monochrome Micro-Graphic panel. If two C-more Micro-Graphic panels are connected to both ports, then at least one of the panels must be powered by a C-more Micro DC power adapter, EA-MG-P1 or EA-MG-SP1, or another 24VDC power source. Color C-more Micro-Graphic panels must also be powered from a separate 24VDC source.

Port 1 (Ethernet) – Modbus TCP

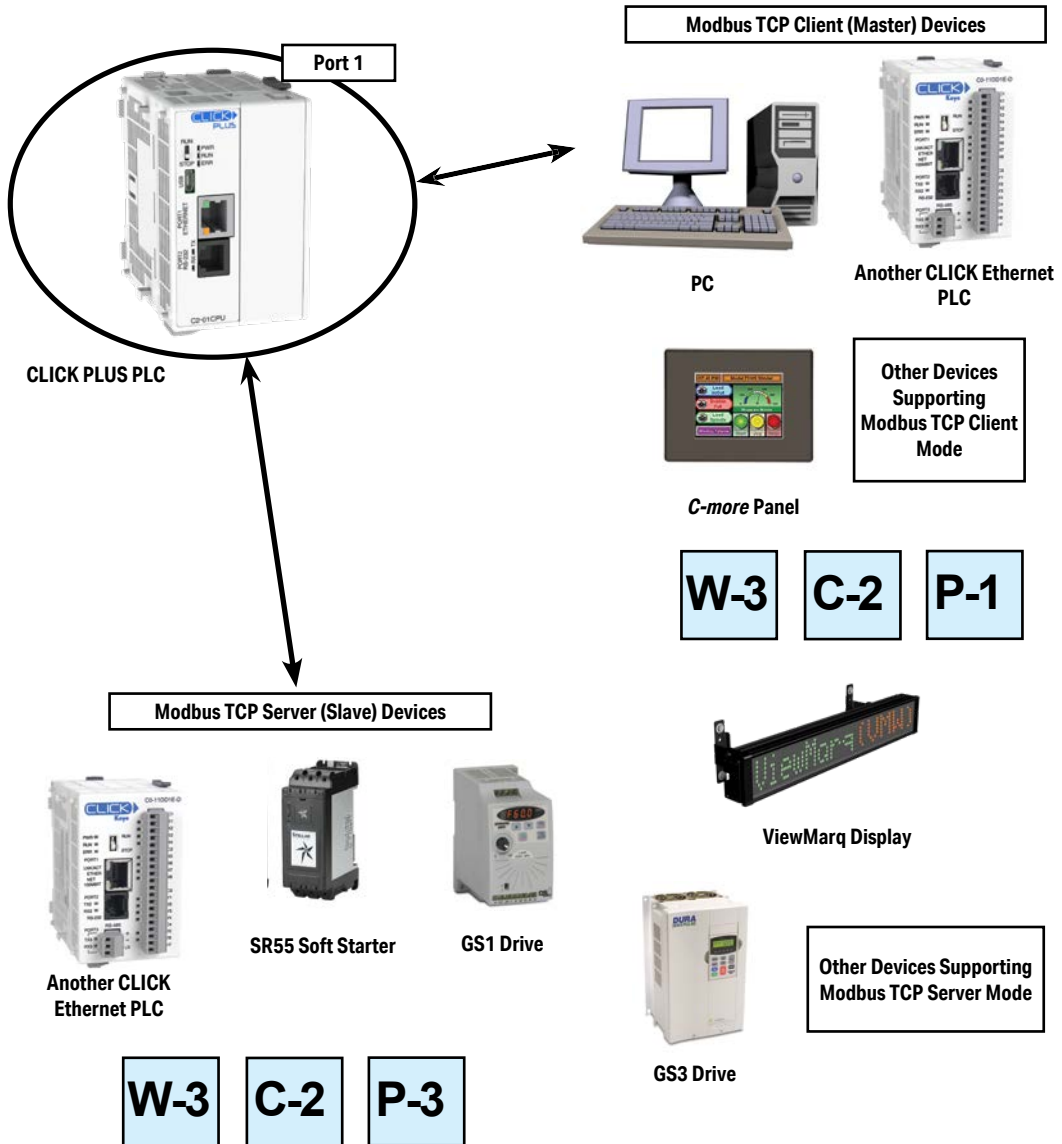

Port 2 (RS-232) – Modbus RTU or ASCII

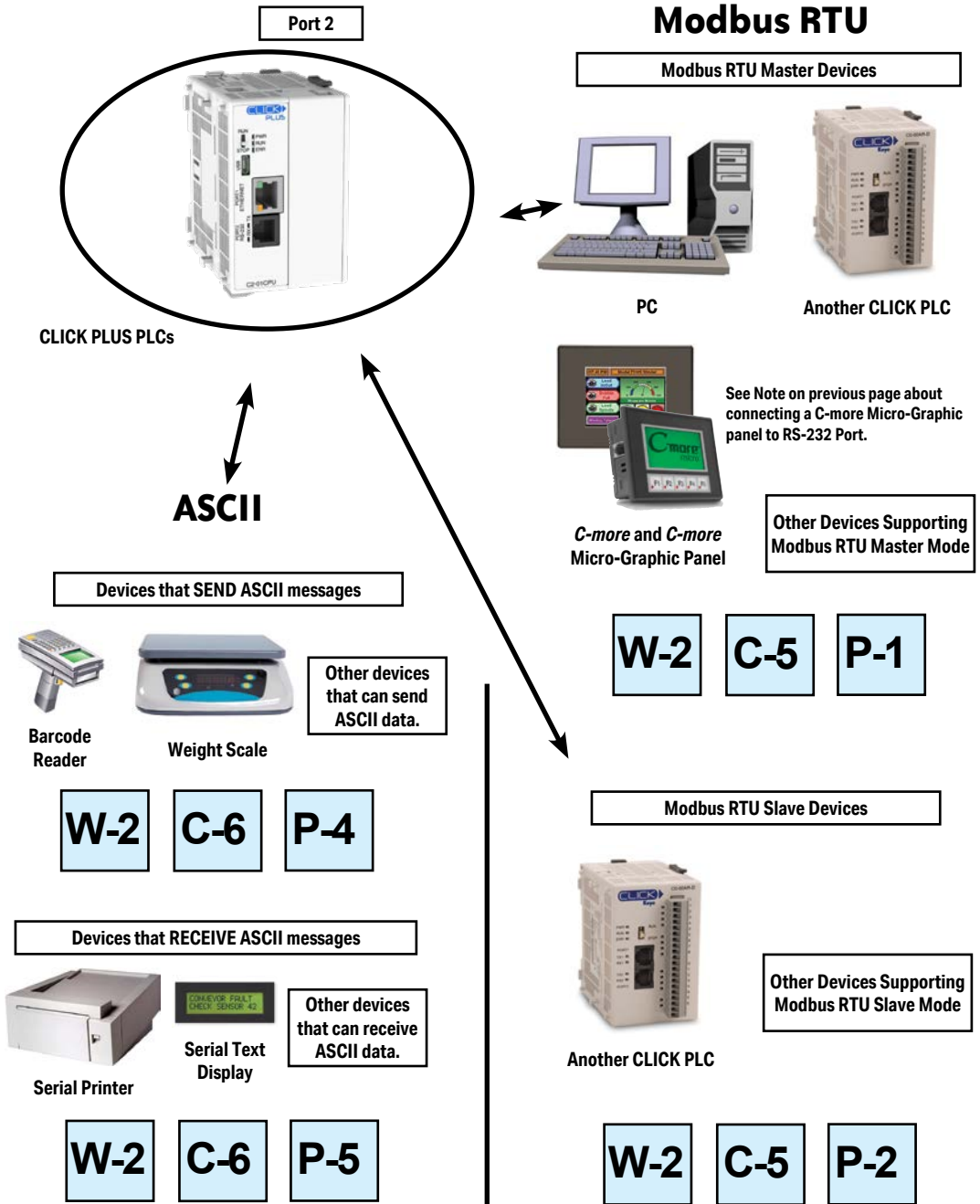

Port 3 (RS-485 – Modbus RTU or ASCII)

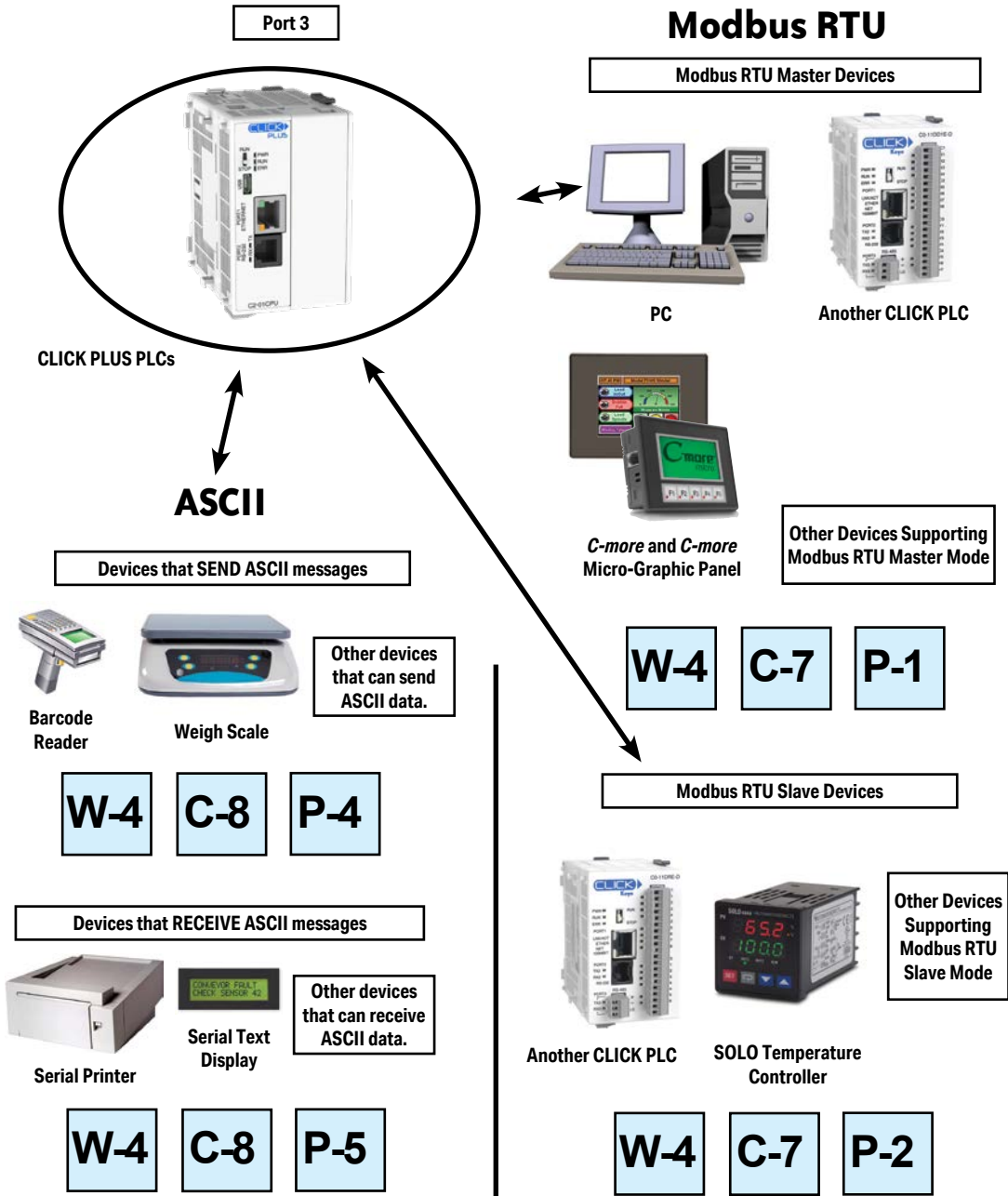

W-1 W-1: USB Port Wiring

USB Port wiring pinout is shown below.

USB Port Pin Descriptions		
1	VBUS	5V Power supply in
2	D-	Differential signal -
3	D+	Differential signal +
4	NC	Not connected (ID not used)
5	GND	Ground

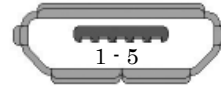

Wiring Strategy

Connect any CLICK PLUS CPU to a USB A port on a Windows PC, using cable USB-CBL-AMICB6 or equivalent.

NOTE: The CLICK PLUS CPU can be supplied 5VDC power from a PC over the USB port when no 24VDC power is applied, with the following capabilities and restrictions



Available:

- Programming over Port 1, Port 2, and Port 3
- Firmware update
- CLICK Factory Default and CLICK Project Loader Tools
- Modbus Server/Slave over Port 1, Port 2, and Port 3
- Option Slot module can be identified in software

Not Available:

- RUN mode is disabled
- WLAN and Bluetooth are disabled
- Access to the microSD Card from software is disabled

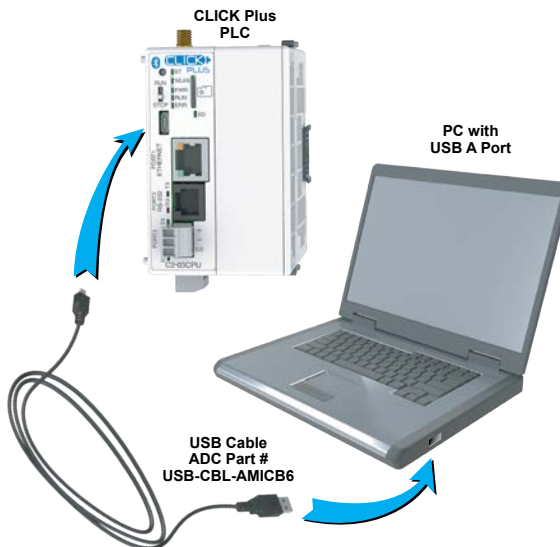

W-2

W-2: Com Port 2 (RS-232) Wiring

Com Port 2 wiring pinout is shown below.

6 pin RJ12 Phone
Type Jack

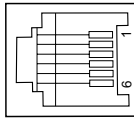

Port 2 Pin Descriptions		
1	0V	Power (-) connection (GND)
2	5V	Power (+) connection
3	RXD	Receive data (RS-232)
4	TXD	Transmit data (RS-232)
5	RTS	Request to send
6	0V	Power (-) connection (GND)



NOTE: Com port 2 can provide 5VDC; however, the 5VDC power can be used only for the C-more Micro-Graphic panel. AutomationDirect does not guarantee that the CLICK PLUS PLC will work correctly when any other device uses 5VDC from these Com ports. Please also remember these Com ports can provide enough power only for one C-more Micro-Graphic panel.

Wiring Strategy

The following pages cover five case scenarios for connecting com port 2:

Case 1: Connect Com Port 2 to a PC.

Case 2: Connect Com Port 2 to another CLICK PLC.

Case 3: Connect Com Port 2 to a C-more or C-more Micro-Graphic panel.

Case 4: Connect Com Port 2 to an RS-422 or RS485 port on another device(s).

Case 5: Connect Com Port 2 to an RS-232 port on another device.

Case 1: Connect Com Port 2 to a PC.

You can connect Com Port 2 to a serial com port or USB port on the PC.

1. Connect to a serial port

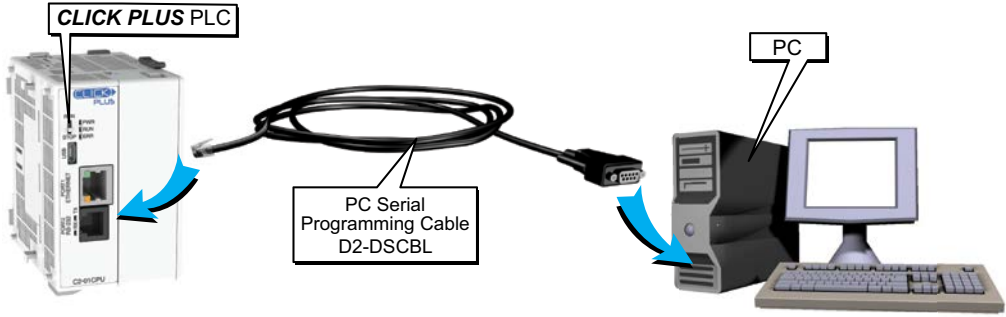

Case 2: Connect Com Port 2 to another CLICK PLC

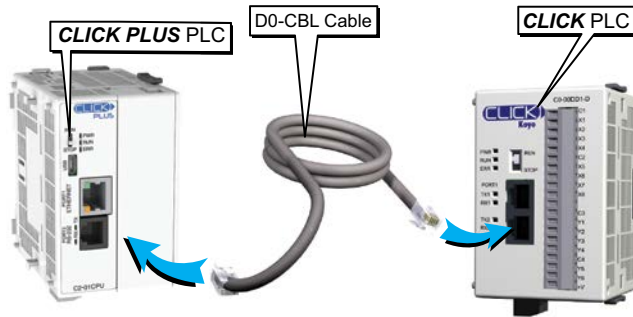

You can use cable D0-CBL.

In this configuration, one of the CLICK/CLICK PLUS PLC units needs to be the network master and the other is the network slave. Connect the D0-CBL on Com Port 2 on the master PLC unit side.



WARNING: The ZL-RJ12-CBL-2 cable cannot be used for this purpose.

Case 3: Connect Com Port 2 to a C-more or C-more Micro-Graphic panel

Please use the following cables to make your connections.

C-more Graphic Panel	Cable Part Number
C-more Touch panels	EA-2CBL (3m) or OP-2CBL (2m)
C-more Micro-Graphic Panels	DV-1000CBL if the panel receives 5VDC power from the CLICK PLC com port. (Monochrome panels only; color panels must be powered from a separate 24VDC power source. Please refer to the note on page 4-6 for details.)
	EA-2CBL (3m) or OP-2CBL (2m) if the panel receives 24VDC power from other source.

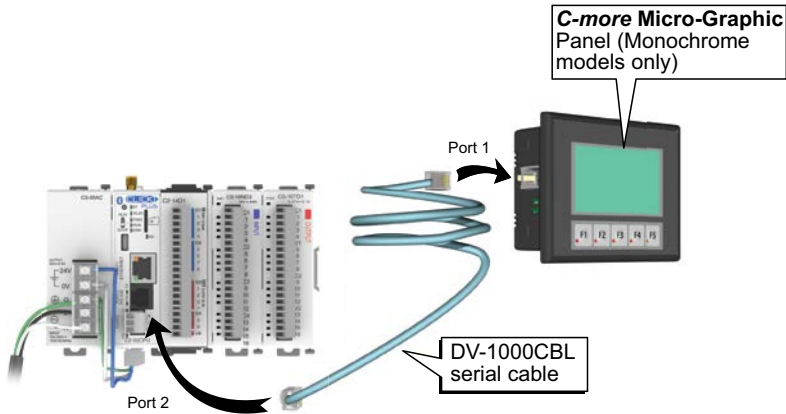

Case 4: Connect Com Port 2 to an RS-422 or RS485 port on another device(s).

You need a RS-232 to RS-422/485 converter in this case. We recommend our FA-ISOCOON as the converter.

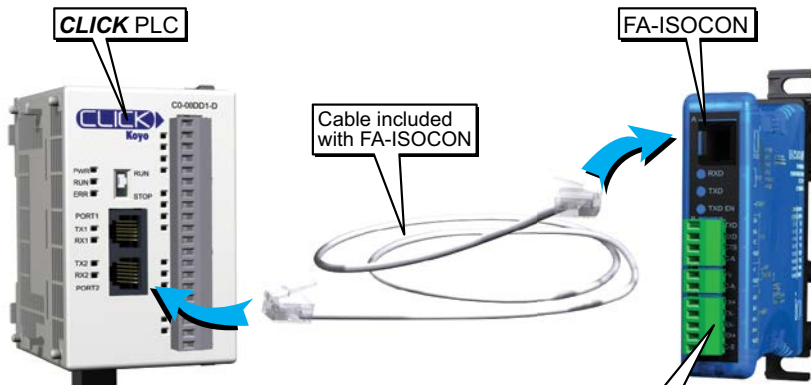

The recommended cables to connect the FA-ISOCOON to other devices:

- Belden 8103 for the RS-422
- Belden 9842 for 2-wire RS-485
- Belden 9843 for 4-wire RS-485

Case 5: Connect Com Port 2 to an RS-232 port on another device

You need to cross the RTD and TXD signal lines and connect 0V on both com ports.

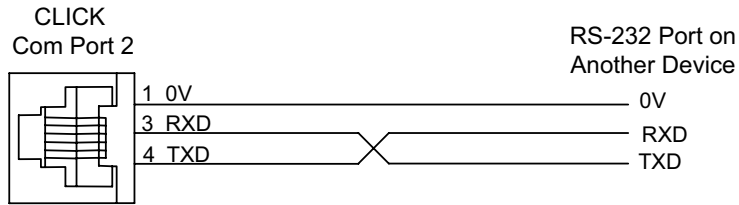

You can make your own cable. However, we offer two products that make your wiring much easier:

1. ZIPLink feed-through module and cable

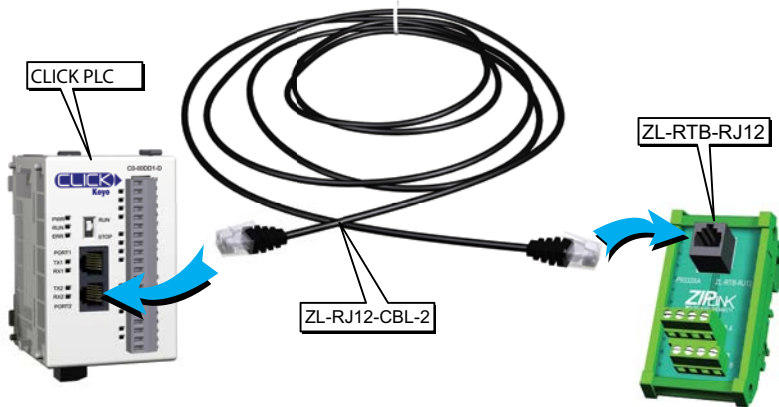

2. ZIPLink pig-tail cable

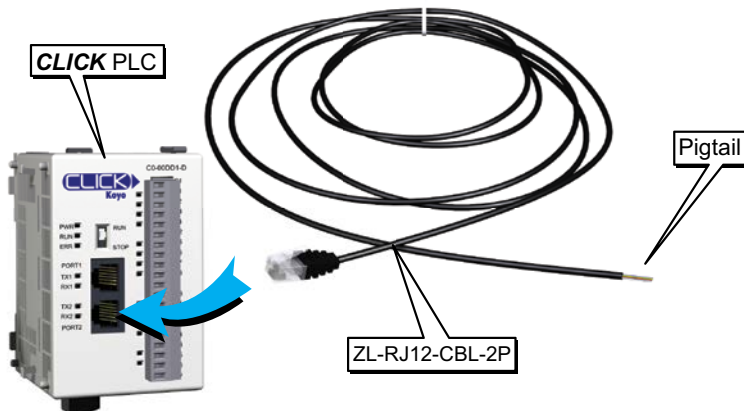

W-3 W-3: Com Port 1 (Ethernet) Wiring

Com Port 1 (Ethernet) supports 10/100 Base-T Ethernet with an RJ-45 style connector.

8 pin RJ45 Phone Type Jack

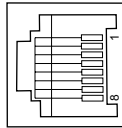

Port 1 Pin Descriptions		
1	TX+	Transmit Data (+)
2	TX-	Transmit Data (-)
3	RX+	Receive data (+)
4	NC	Not connected
5	NC	Not connected
6	RX-	Receive Data (-)
7	NC	No connection
8	NC	No connection

You can use both straight and cross over cables with Com Port 1.

Wiring Strategy

- There are two wiring methods to connect to devices which support Modbus TCP protocol.
- Case 1: Connect Com Port 1 to a device that supports Modbus TCP protocol directly such as a PC.
- Case 2: Connect Com Port 1 to other devices that support the Modbus TCP protocol via a switch or hub.

Case 1: Connect Com Port 1 to a device that supports the Modbus TCP protocol directly such as a PC.

In this illustration a PLC unit is connected directly to a PC.

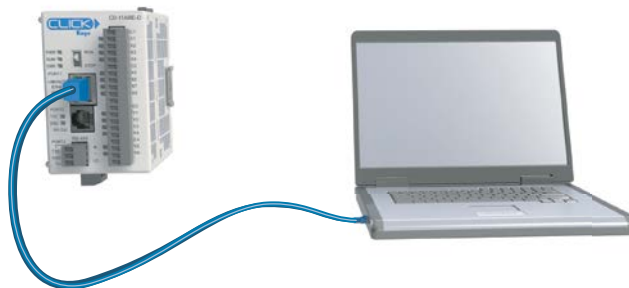

Case 2: Connect Com Port 1 to other devices that support the Modbus TCP (client/server) protocol via a switch or hub.

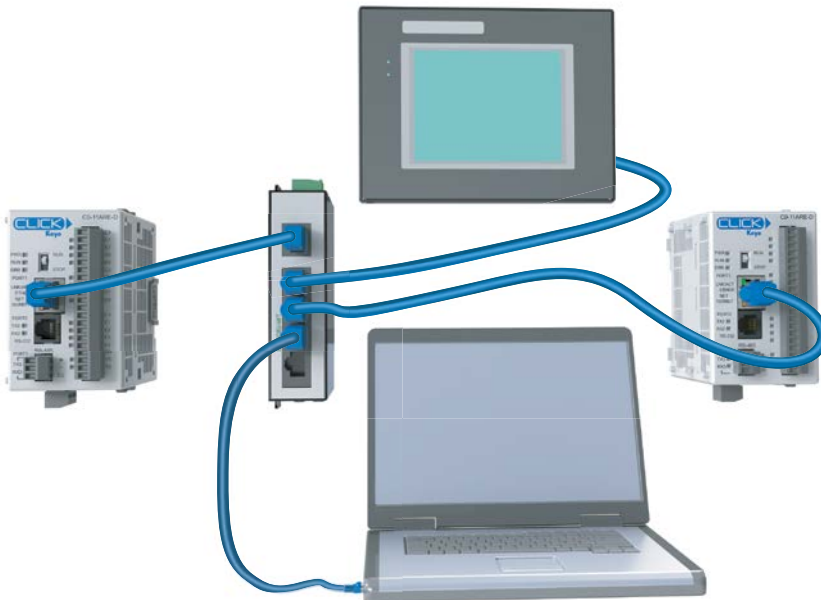

NOTE: Com Port 1 can communicate with any number of servers (slaves) using the Receive and/or Send instructions. However, Com Port 1 can communicate with up to 4 servers at the same time. If the ladder program has sent a message to 4 different servers and tries to send a message to another server, the CLICK PLUS PLC unit disconnects the first server and establishes a connection with the new server, maintaining a total of 4 servers.



NOTE: Com Port 1 can communicate with up to 3 clients (masters). If a client attempts to establish communication with Com Port 1 while it is communicating with 3 clients, the CLICK PLUS PLC unit replies with an error to the fourth client.

W-4

W-4: Com Port 3 Wiring

Com Port 3 supports 2-wire RS-485.

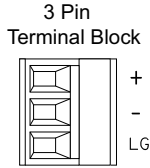

Port 3 Pin Descriptions	
1	+ (Plus) Signal A (RS-485)
2	- (Minus) Signal B (RS-485)
3	LG Logic Ground (0 V)

Wiring Strategy

You need to connect all + signal terminals in the network together. You will also need to connect all - signal terminals together. It is optional to connect the logic ground.

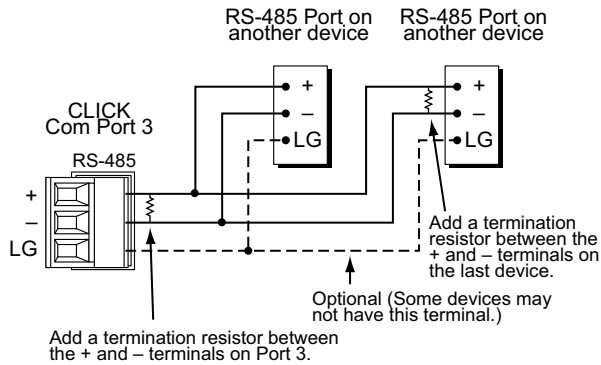

NOTE: The resistance of the termination resistors needs to match the impedance of the communication cable.



NOTE: Use a repeater if connecting more than 32 slaves to Port 3.

W-5 W-5: C2-DCM Com Port RS-232 Wiring

C2-DCM Com Port wiring pinout is shown below.

6 Pin
Terminal Block

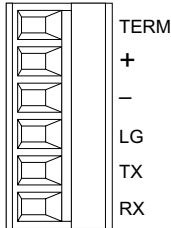

Ports 1 and 2

C2-DCM Port Pin Descriptions		
1	TERM	not used for RS-232
2	+ (Plus)	not used for RS-232
3	- (Minus)	not used for RS-232
4	LG	Logic Ground (0 V)
5	TX	RS-232 Transmit
6	RX	RS-232 Receive

Wiring Strategy

You need to cross the RX and TX signal lines and connect 0V on both com ports.

You can make your own cable. However, we offer pigtail cables with prewired connectors for many AutomationDirect products. Please check www.automationdirect.com for compatible cables.

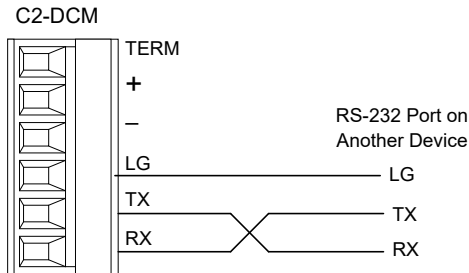

W-6 W-6: C2-DCM Com Port RS-485 Wiring

The C2-DCM com ports support 2-wire RS-485.

6 Pin Terminal Block

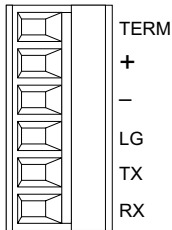

C2-DCM Port Pin Descriptions		
1	TERM	120Ω resistor
2	+ (Plus)	Signal A (RS-485)
3	- (Minus)	Signal B (RS-485)
4	LG	Logic Ground (0 V)
5	TX	not used for RS-485
6	RX	not used for RS-485

Wiring Strategy

You need to connect all + signal terminals in the network together. You will also need to connect all – signal terminals together. It is optional to connect the logic ground.

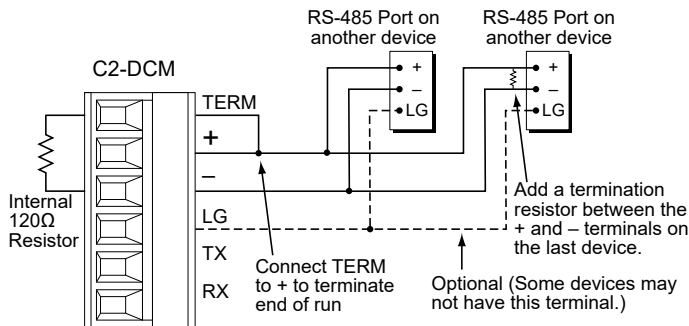

NOTE: The C2-DCM ports include an internal 120Ω internal resistor between TERM and - (Minus). When the C2-DCM is at the end of an RS-485 run, connect TERM and + (Plus) to terminate the line.



NOTE: The resistance of the termination resistors needs to match the impedance of the communication cable.



NOTE: Use a repeater if connecting more than 32 slaves.

C-1 C-1: USB Port Setup

The CLICK PLUS USB port is only used to connect to the CLICK programming software. When a CLICK PLUS device is first connected to a USB port on a Windows PC, a driver is loaded to allow the CLICK PLUS device to emulate a standard serial port. The CLICK PLUS will show up as a USB Serial Device in under Ports in Windows Device Manager.

To connect via USB port, click Connect in the PLC menu, then select USB as the port type. Select the COM port assigned to the USB Serial Device. All other parameters can be left at their default settings.

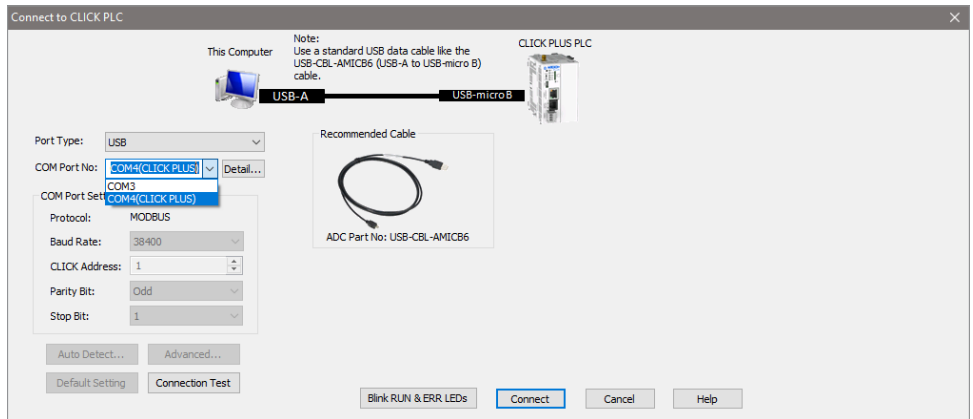

C-2 C-2: Com Port 1 (Ethernet) Setup

Select the Function tab located in the Navigation window of the CLICK Programming Software and double click “Com Port 1 Setup” as shown below.

The Com Port Setup Details dialog box will come into view as shown below.

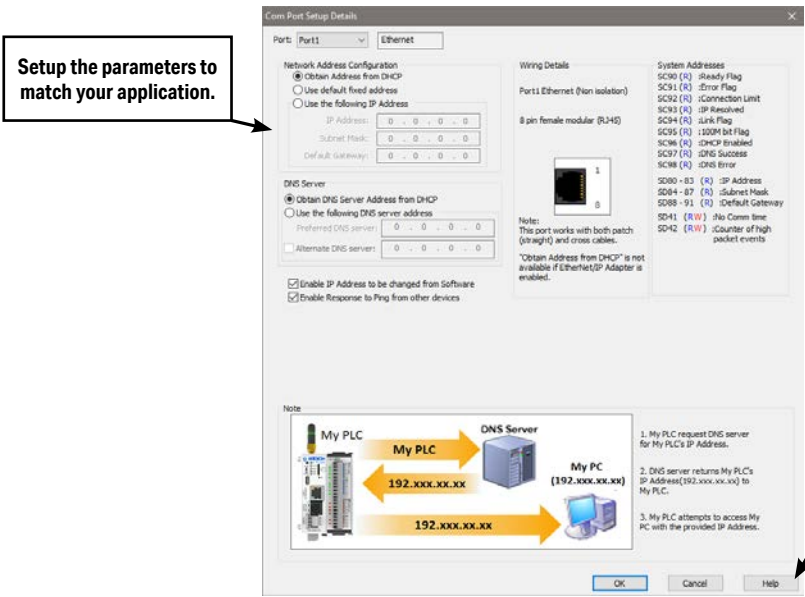
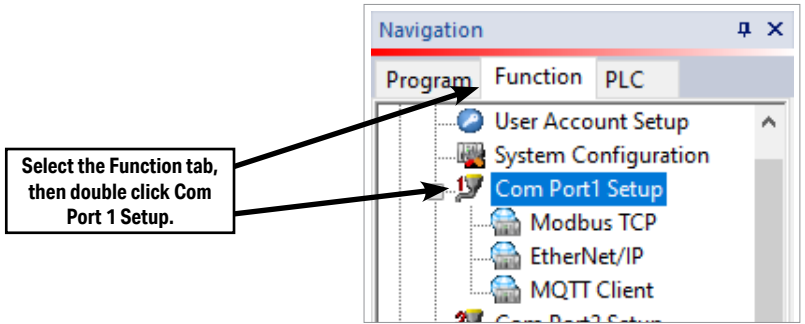

NOTE: The communication port settings are saved in the project file. The project must be transferred to the CLICK PLUS PLC in order for any port setting changes to take effect.

C-3 C-3: Wireless LAN (WLAN) Setup

Select the **Function** tab located in the Navigation window of the CLICK Programming Software and double click “Com Port 1 Setup” as shown below.

The Com Port Setup Details dialog box for the WLAN will come into view as shown below.

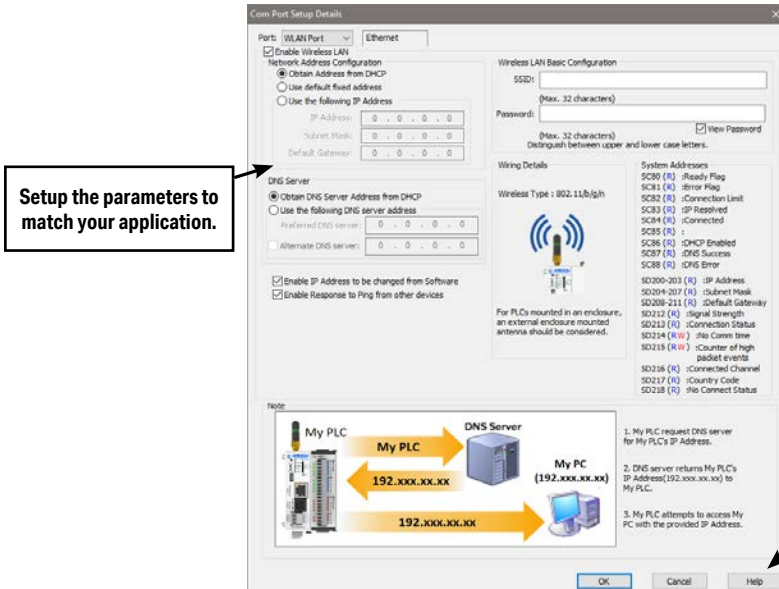
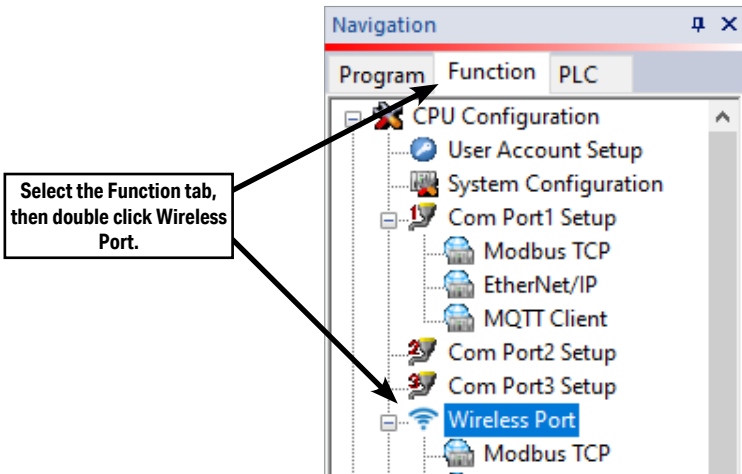

NOTE: The communication port settings are saved in the project file. The project must be transferred to the CLICK PLUS PLC in order for any port setting changes to take effect.



C-4 C-4: Bluetooth Setup

The Bluetooth connection available on certain CLICK PLUS CPUs is used for initial setup and provisioning of a wireless network connection and for connecting to the Remote PLC App. It provides a method to get a CLICK PLUS CPU connected to a wireless network so that the CLICK programming software on a PC can find the device, finish the setup and load a project.

The process for Bluetooth connection and WLAN provisioning is discussed in Chapter 1, Getting Started. For further information, please see the Bluetooth help topic in the CLICK programming software.

C-5 C-5: Com Port 2 Setup (Modbus RTU)

Select the Function tab located in the Navigation window and double click Com Port2 Setup as shown below.

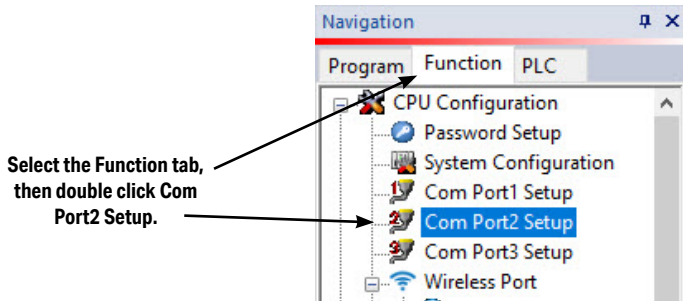

Select the Function tab, then double click Com Port2 Setup.

The Com Port Setup Details dialog box will come into view as shown below.

Find the Basic Configuration section in the dialog box and set up the parameters to match other devices in the same network. The dialog box also has a section named Advanced Configuration.

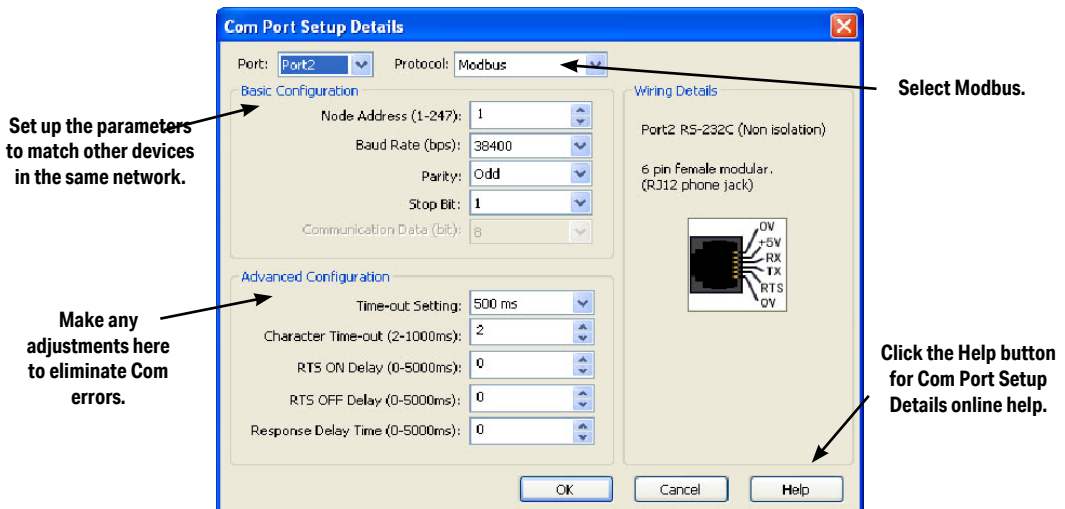

Set up the parameters to match other devices in the same network.

Make any adjustments here to eliminate Com errors.

Select Modbus.

Click the Help button for Com Port Setup Details online help.

You may need to make adjustments to these parameters to overcome communication errors which may occur.



TIP: The communication port settings are saved in the project file. The project must be transferred to the CLICK PLUS PLC in order for any port setting changes to take effect.

C-6: Com Port 2 Setup (ASCII)

Select the Function tab located in the Navigation window and double click Com Port2 Setup as shown below.

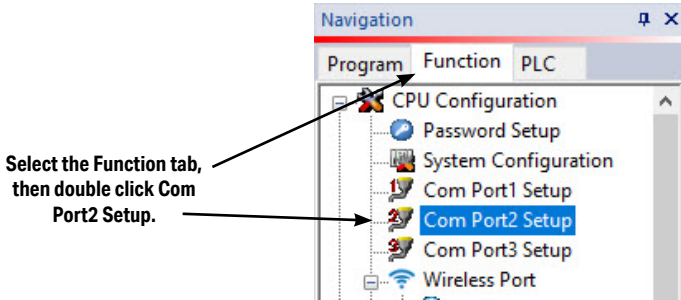

The Com Port Setup Details dialog box will come into view as shown below.

Find the Basic Configuration section in the dialog box and set up the parameters to match the

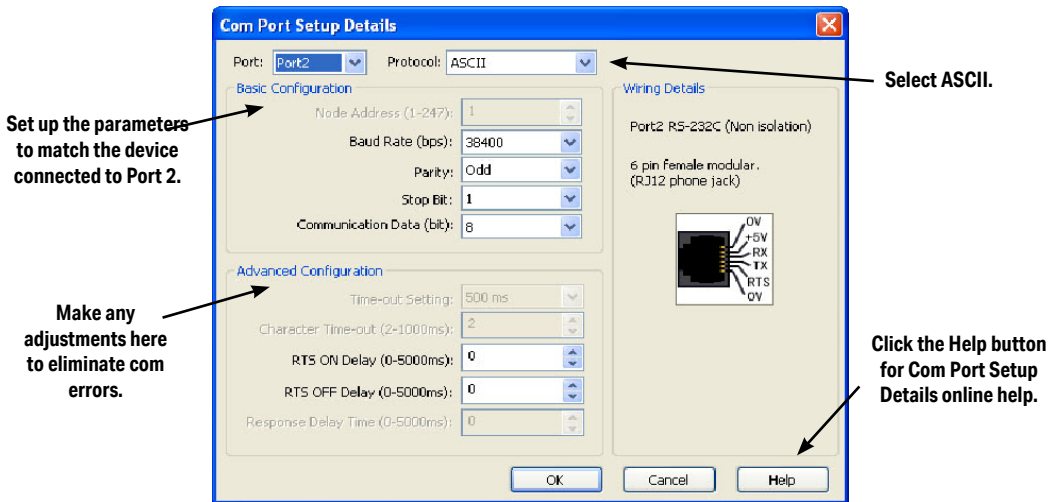

device connected to Port 2. The dialog box also has a section named Advanced Configuration. You may need to make adjustments to these parameters to overcome communication errors which may occur.



TIP: The communication port settings are saved in the project file. The project must be transferred to the CLICK PLUS PLC in order for any port setting changes to take effect.

C-7 C-7: Com Port 3 Setup (Modbus RTU)

Select the Function tab located in the Navigation window and double click Com Port3 Setup as shown below.

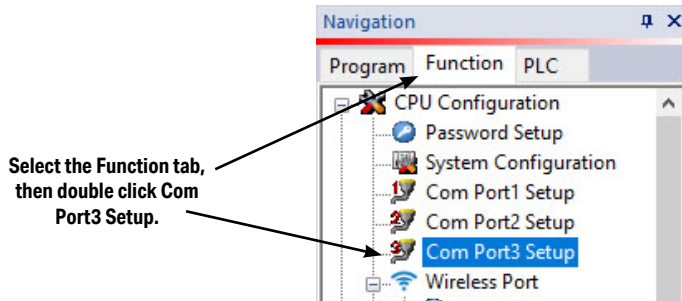

The Com Port Setup Details dialog box will come into view as shown below.

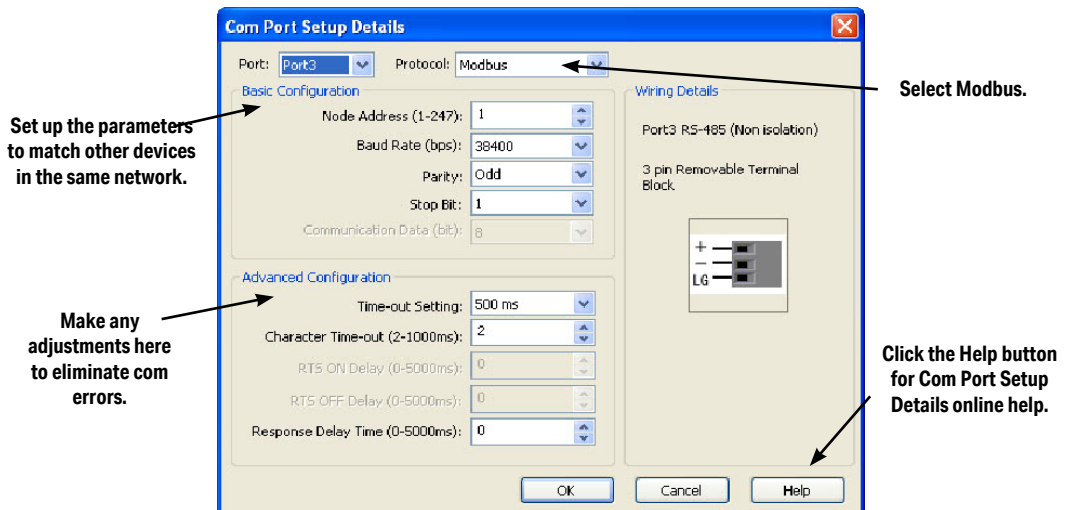

Find the Basic Configuration section in the dialog box and set up the parameters to match other devices in the same network. The dialog box also has a section named Advanced Configuration. You may need to make adjustments to these parameters to overcome communication errors which may occur.



TIP: The communication port settings are saved in the project file. The project must be transferred to the CLICK PLUS PLC in order for any port setting changes to take effect.

C-8 C-8: Com Port 3 Setup (ASCII)

Select the Function tab located in the Navigation window and double click Com Port3 Setup as shown below.

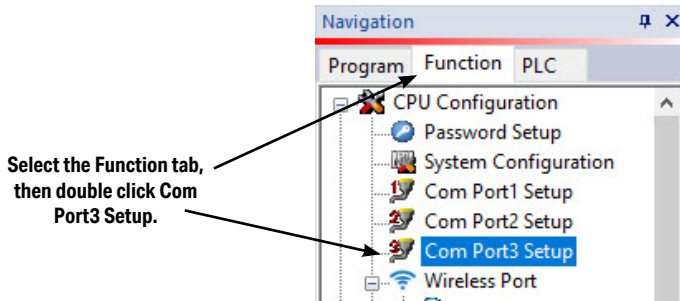

The Com Port Setup Details dialog box will come into view as shown below.

Find the Basic Configuration section in the dialog box and set up the parameters to match the

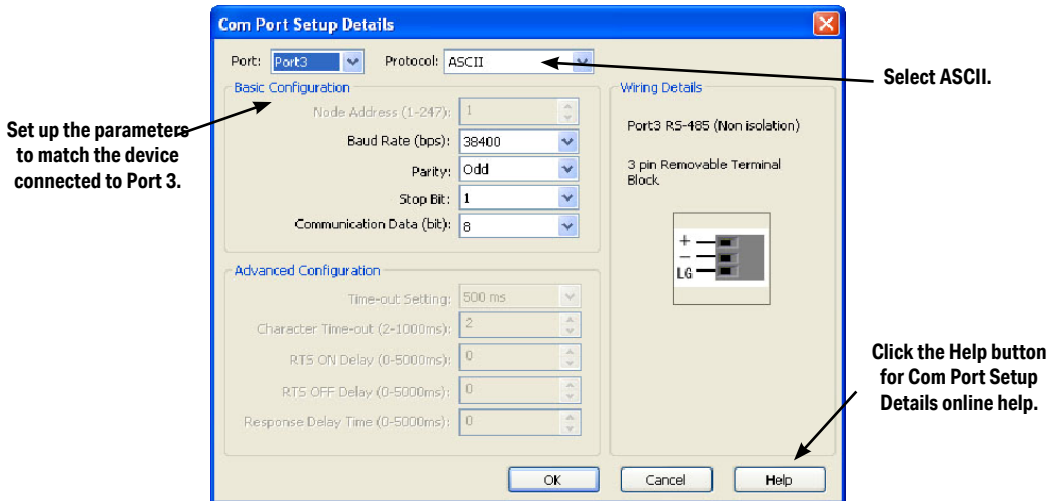

device connected to Port 3.



TIP: The communication port settings are saved in the project file. The project must be transferred to the CLICK PLUS PLC in order for any port setting changes to take effect.

C-9: C2-DCM Com Port 1 or 2 Setup (ASCII)

Select the Function tab located in the Navigation window and double click Com Port1 Setup or Com Port2 Setup under the Slot0 or Slot1 Data Communication Module, as shown below.

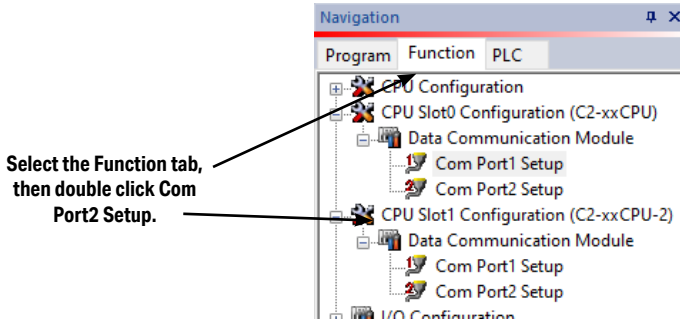

Select the Function tab, then double click Com Port2 Setup.

The Com Port Setup Details dialog box will come into view as shown below.

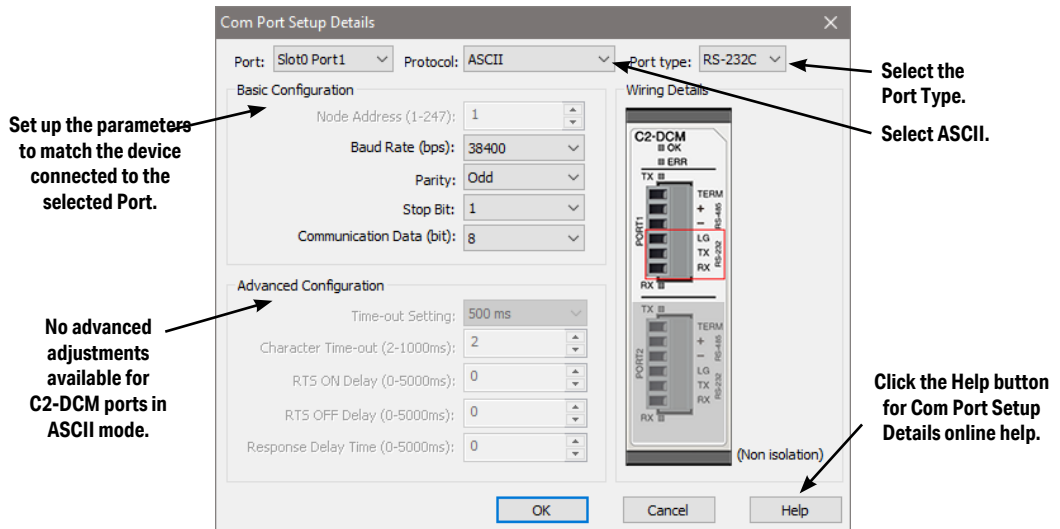

Set up the parameters to match the device connected to the selected Port.

No advanced adjustments available for C2-DCM ports in ASCII mode.

Select the Port Type.
Select ASCII.

Click the Help button for Com Port Setup Details online help.

Select your Port type and Protocol. Find the Basic Configuration section in the dialog box and set up the parameters to match the device connected to the port. The dialog box also has a section named Advanced Configuration, but no advanced configuration parameters are available in ASCII mode.



TIP: The communication port settings are saved in the project file. The project must be transferred to the CLICK PLUS PLC in order for any port setting changes to take effect.

C-10 C-10: C2-DCM Com Port 1 or 2 Setup (Modbus RTU)

Select the Function tab located in the Navigation window and double click Com Port1 Setup or Com Port2 Setup under the Slot0 or Slot1 Data Communication Module, as shown below.

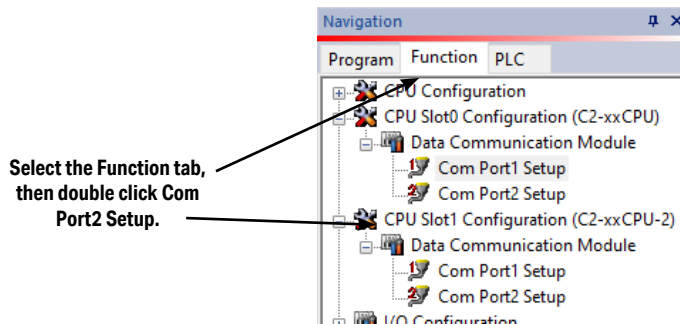

The Com Port Setup Details dialog box will come into view as shown below.

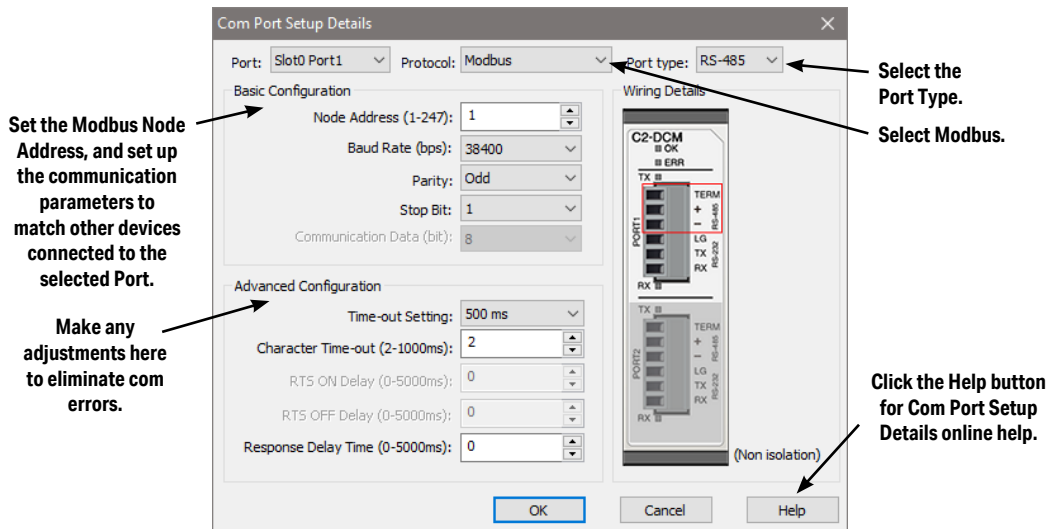

Select your Port type and Protocol. Find the Basic Configuration section in the dialog box and set up the parameters to match other devices in the same network. The dialog box also has a section named Advanced Configuration. You may need to make adjustments to these parameters to overcome communication errors which may occur.



TIP: The communication port settings are saved in the project file. The project must be transferred to the CLICK PLUS PLC in order for any port setting changes to take effect.

P-1 P-1: Modbus Slave (Server) Programming

Ladder Program

To use a CLICK PLUS PLC as a Serial Modbus slave, you don't need any special ladder program. Set up the communication port properly and you just need an End instruction in the ladder program to put the PLC in Run mode.



To use CLICK PLUS PLC as a Modbus Ethernet Client, the Modbus TCP Server must be enabled.

To enable the Modbus TCP Server, select the **Function** tab located in the Navigation window and expand “Com Port 1 Setup” and double click on Modbus TCP as shown below.

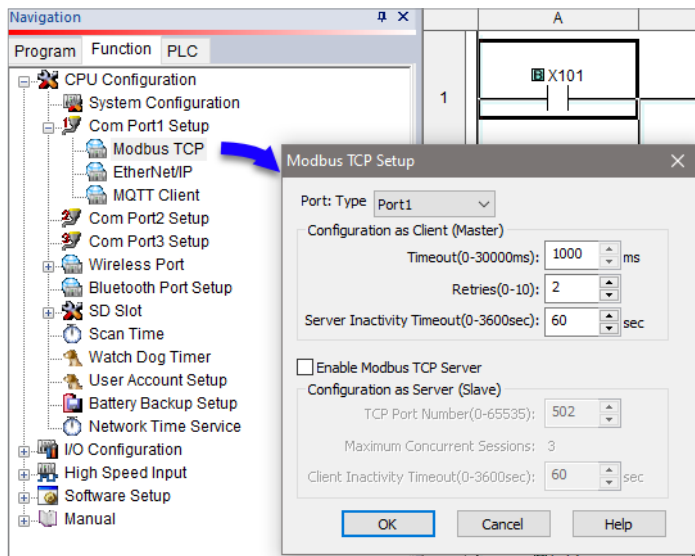

You can add any additional ladder program to let the slave CLICK PLUS PLC control something by itself. For instance, you may want to shut down the outputs on the slave (server) CLICK PLUS PLC should it lose communication with the Modbus master (client).



NOTE: The Modbus master can communicate with the Modbus slave CLICK PLUS PLC without any ladder program. However, output points on the Modbus slave CLICK PLUS PLC cannot be turned on if the PLC is not in the Run mode. Because of this, we recommend having at least one End instruction and to put the PLC in Run mode.

Lost Communication Situation

You may want to detect if there is something happening at the Modbus master side that stops communication with the Modbus slaves. Or, the communication cable might have been disconnected. In this situation, you may want the Modbus slaves to take an action. For instance, you may want to shut down the outputs on the slave CLICK PLUS PLC when the communication with the Modbus master is lost. We offer an easy method to accomplish this.

The CLICK keeps counting how long it has been since each com port received a message from the Modbus master, and enters the time duration in the following system data registers.

System Data Registers		
System Data Register	Nickname	Range
SD41	_Port1_No_Comm_Time	0 - 32767 (sec)
SD51	_Port2_No_Comm_Time	0 - 32767 (sec)
SD61	_Port3_No_Comm_Time	0 - 32767 (sec)
SD214	_WLAN_No_Comm_Time	0 - 32767 (sec)

Each register is reset to zero automatically when the com port receives a message from the Modbus master. Then its value increments by 1 per second until the com port receives another message from the Modbus master. If one of these registers has 60 as its value, it means the com port has not received any message from the Modbus master for 60 seconds. You can use this info to shut down the outputs on the slave CLICK PLUS PLC. Here is an example program.

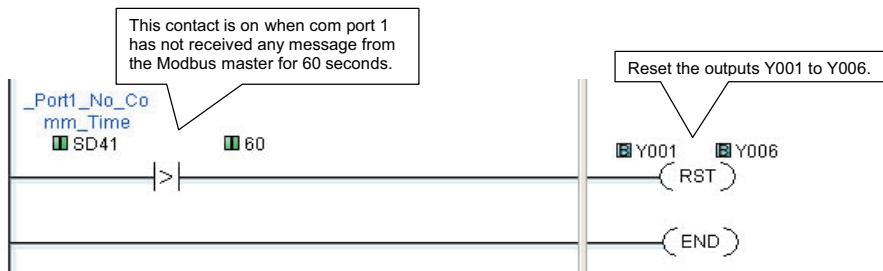

Modbus Addressing

Each of the memory addresses in the CLICK (X1, DS1, etc.) has a unique Modbus address. This means the network master in the Modbus network can access any memory address in the slave CLICK PLUS PLC. The best way to check which Modbus address is assigned to a particular CLICK memory address is to use the CLICK programming software.

Click the Program tab located in the Navigation window and double click Address Picker as shown below.

After the Address Picker window opens, check the option Display MODBUS Address on the right bottom.

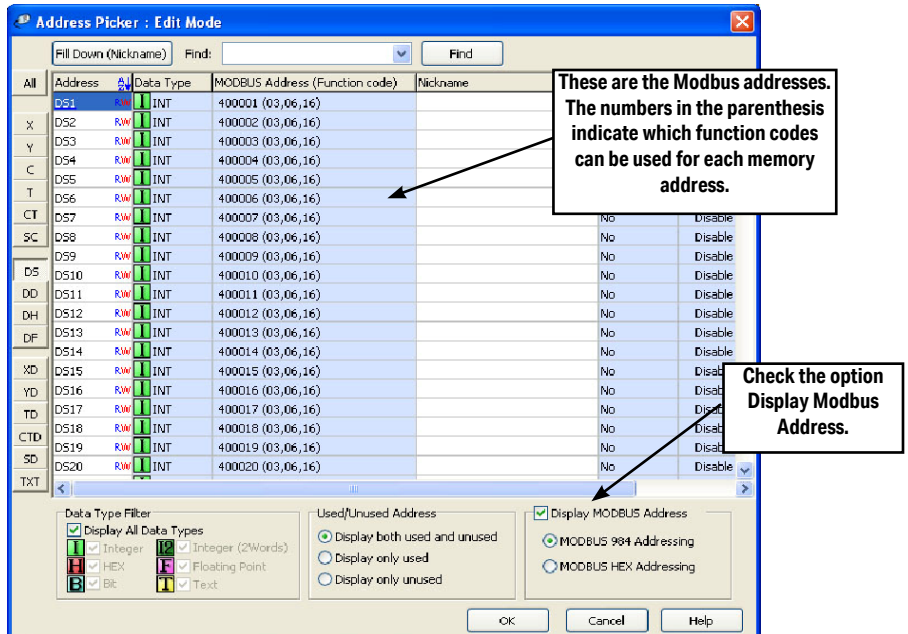
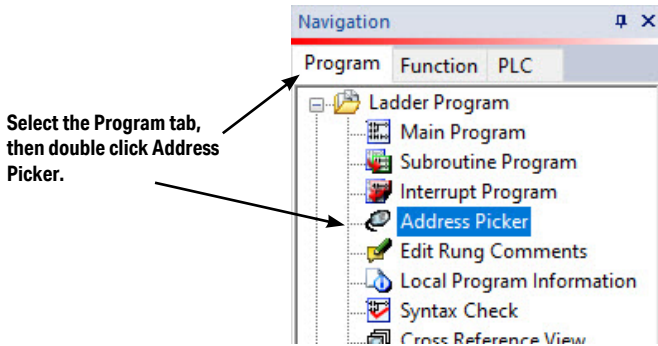

Exception Response (Exception Code)

When the slave CLICK PLUS PLC receives a request from the Modbus master that it cannot respond to, the slave CLICK PLUS PLC sends an exception response to the Modbus master. The CLICK PLUS PLC supports the following Exception Responses.

Exception Response (Exception Code)		
Code	Name	Details of Exception Response
01	Illegal Function	The CLICK PLUS PLC does not support the function code received from the MODBUS master.
02	Illegal Data Address	The MODBUS master tried to access to an invalid address.
03	Illegal Data Value	The data length is zero or exceeds the maximum size.
		The data for Write Single Coil is not FF00h (ON) or 0000h (OFF).
		The PLC mode change request from the MODBUS master is not valid.
04	Slave Device Failure	Password is locked.
		When the PLC mode switch is in STOP position, the MODBUS master requested to switch to RUN mode.
		When the PLC mode switch is in RUN position, the MODBUS master requested to switch to the Firmware Update mode.

P-2 P-2: Modbus Master Programming (Modbus RTU)

Instructions

The CLICK PLUS PLC has two instructions to exchange data with external Modbus devices through the com ports; the Receive and Send instructions.

- Receive instruction: Read data from an external Modbus device.
- Send instruction: Write data to external Modbus device(s).

To use these instructions, double click Receive or Send in the Instruction List window as shown below.

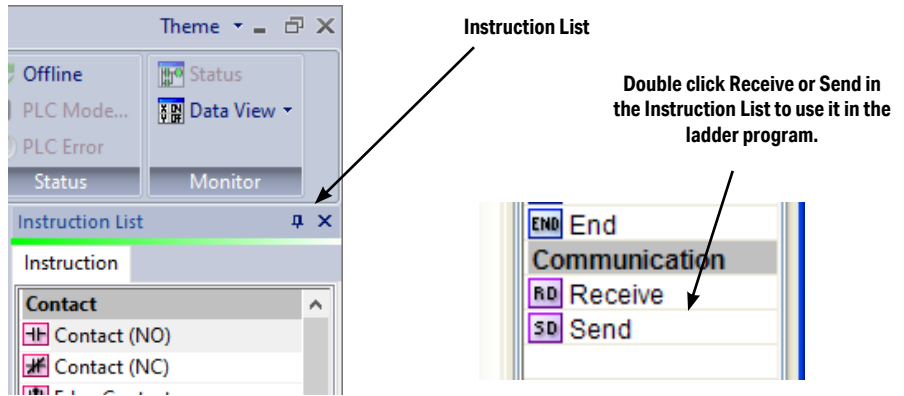

Select the Com Port that you are going to use and confirm the Protocol is MODBUS.

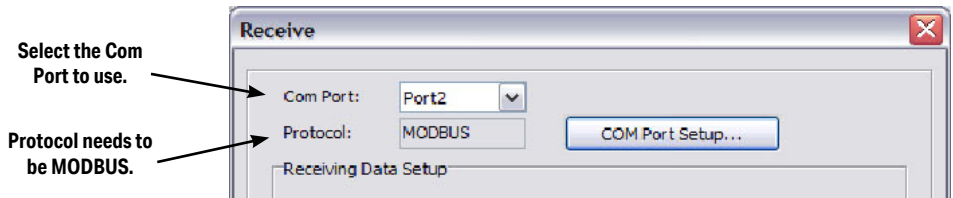

If the Protocol is not MODBUS, click the Com Port Setup button to open the Com Port Setup Details window and change the Protocol to MODBUS. If the Protocol selection is grayed out as shown below, it means the Com Port is used by another Receive and/or Send instruction in the ladder program. You cannot change the Protocol setup until you delete those instructions.



Chapter 4: PLC Communications

When you open the Receive or Send instruction in the Modbus mode, their windows should look like this. For the explanation of each setup parameter, please click the Help button on the bottom right.

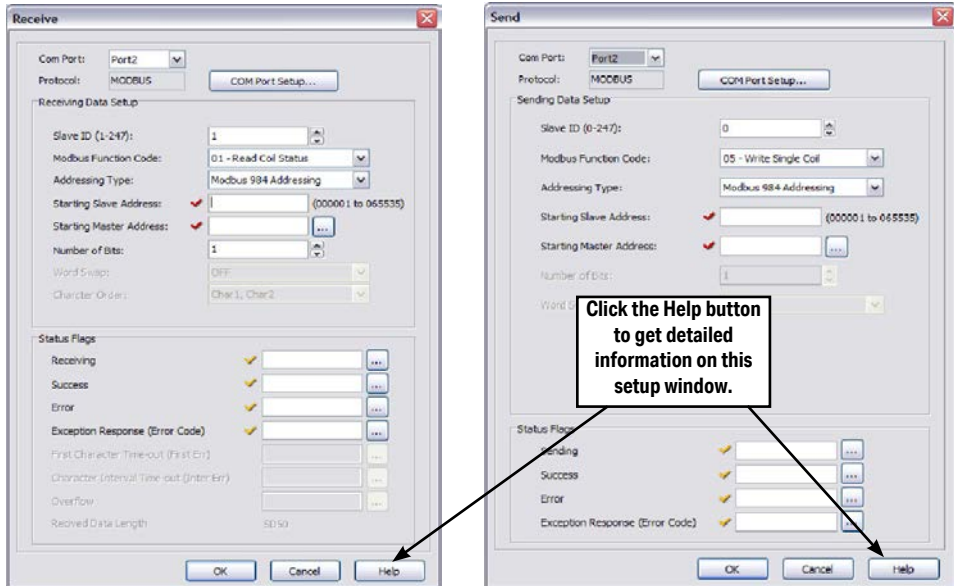

Com Port Status Indicators

The CLICK PLC has the following System Control Relays to indicate the status of the Com Ports. If monitoring these bits in ladder, they should be monitored at a ladder location prior to the Receive or Send instructions for the port.

System Control Relays		
Address	Nickname	Description
SC100	<u>Port_2_Ready_Flag</u>	On when Port 2 is ready.
SC101*	<u>Port_2_Error_Flag</u>	On when Port 2 has a communication error.
SC102	<u>Port_3_Ready_Flag</u>	On when Port 3 is ready.
SC103*	<u>Port_3_Error_Flag</u>	On when Port 3 has a communication error.

* Errors that will cause SC101 or SC103 error flag to turn on:

- Parity Error
- Frame Error
- Time Out
- CRC Error
- Modbus Exception Response

Example Program

The ladder program to use these Receive and Send instructions are easy. You just need one NO (Normally Open) contact instruction to check if the com port is ready to receive or send data.

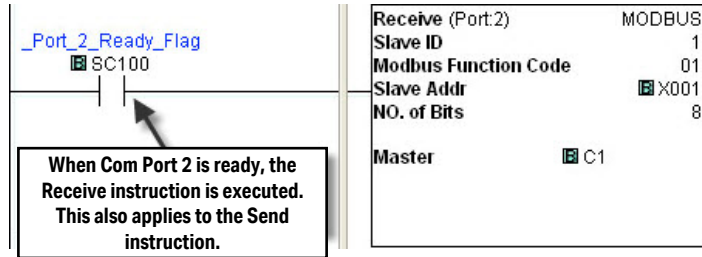

Interlocking

If you are going to use more than one Receive and/or Send instruction with a serial communication port, you need to be sure only one of the instructions is enabled at any point during the operation. The technique to execute more than one Receive and/or Send instructions in order is called 'Interlocking'. When the Interlocking sample program below is executed, the two Receive instructions and two Send instructions are executed one by one.

Example Program: Interlocking with Two Slaves

In this example, Port 3 on the CLICK PLC unit communicates with two MODBUS slaves. The slave IDs (node numbers) are 1 and 2. The CLICK PLC unit executes one Receive instruction and one Send instruction with each MODBUS slave.

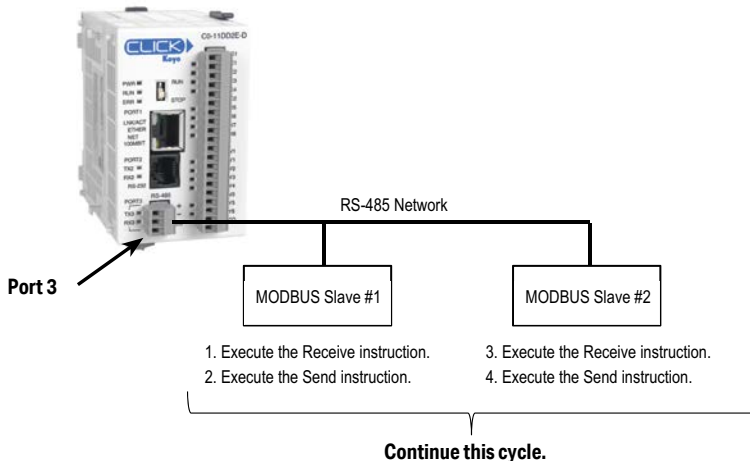

Example Program: Interlocking with Two Slaves (Continued)

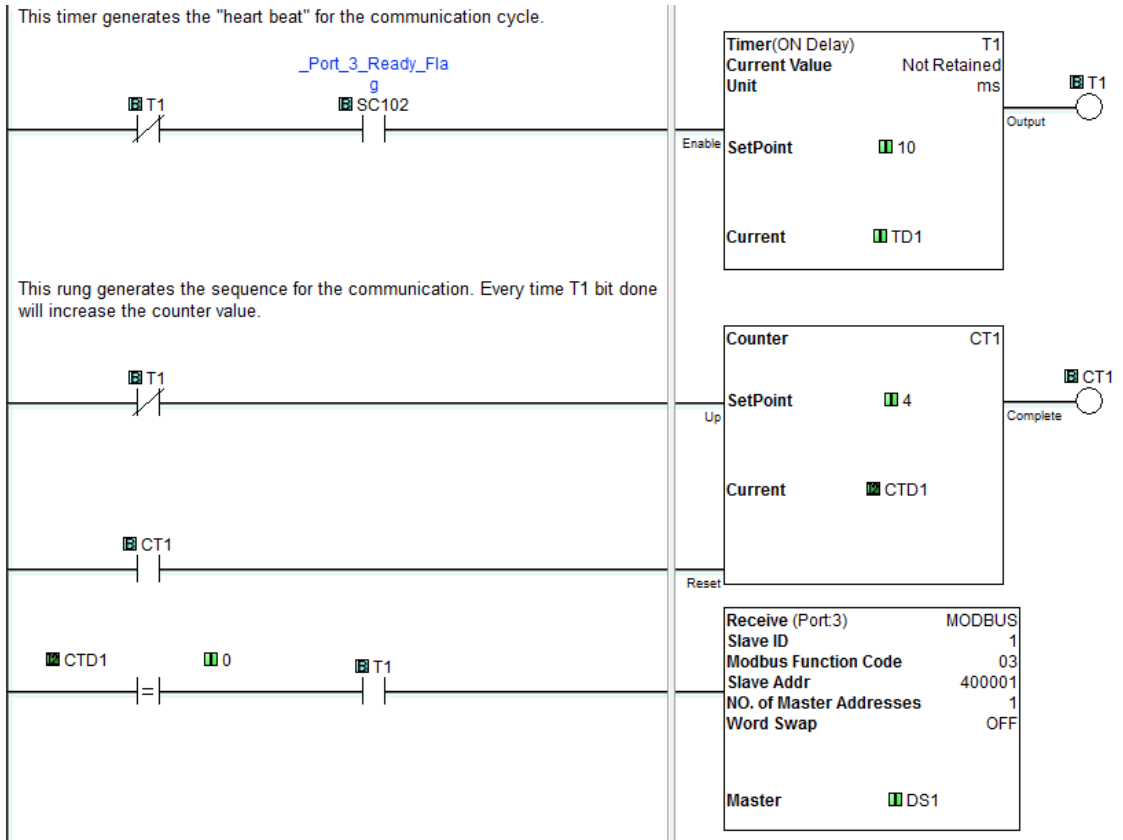

Example Program: Interlocking with Two Slaves (Continued)

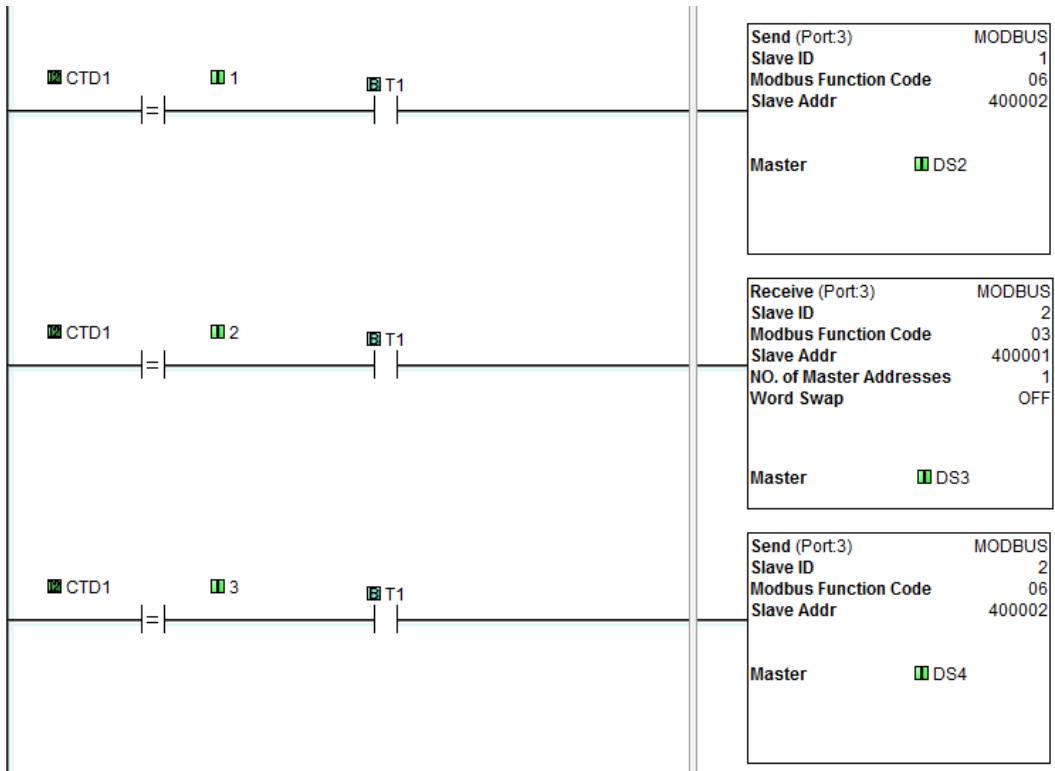

P-3 P-3: Modbus Client (Modbus TCP) Programming

Instructions

The CLICK PLC has two instructions to exchange data with Modbus servers through the Com Port 1; the Receive and Send instructions.

- **Receive** instruction: Read data from external Modbus server.
- **Send** instruction: Write data to external Modbus server(s).

To use these instructions, double click Receive or Send in the Instruction List window as shown below.

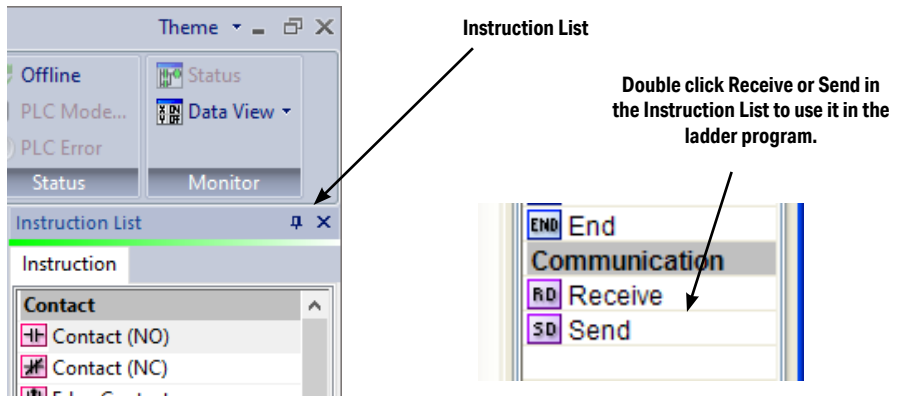

Select Com Port 1 that you are going to use.

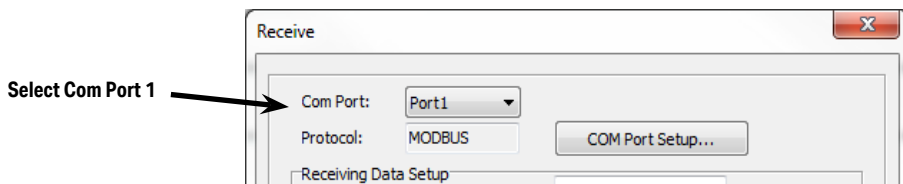

When you open the Receive or Send instruction in the Modbus mode, their windows should look like this. For the explanation of each setup parameter, please click the Help button on the bottom right.

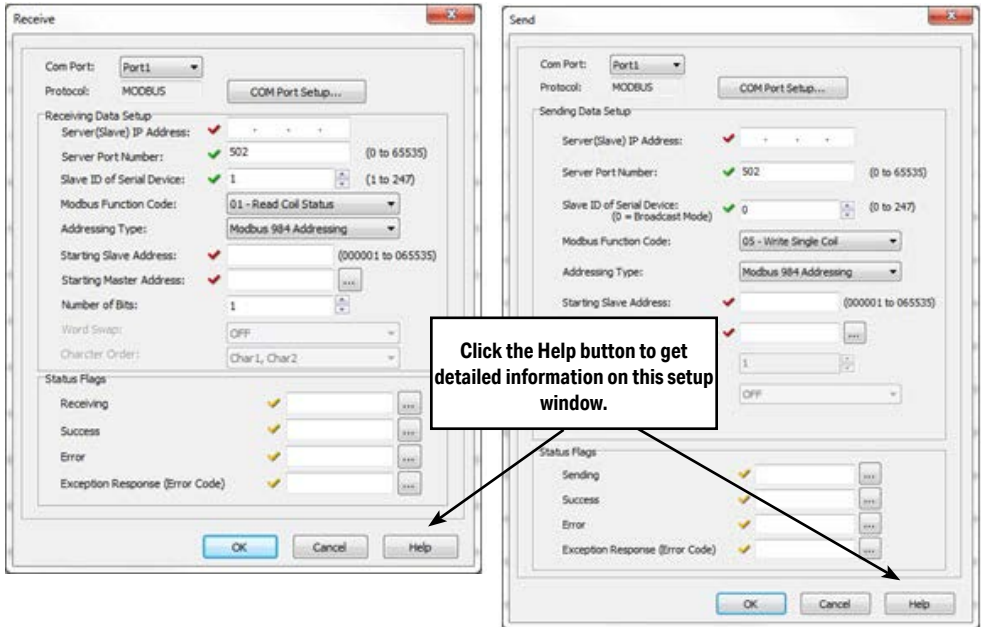

Com Port Status Indicators

The CLICK PLUS PLC has the following System Control Relays to indicate the status of Com Port 1 and the WLAN port.

System Control Relays		
Address	Nickname	Description
SC80	_WLAN_Ready_Flag	ON when WLAN is Ready, does not indicate Busy Status
SC81	_WLAN_Error_Flag	ON when there is a WLAN error. SD213 will contain the error information.
SC82	_WLAN_Connection_Limit	ON when all of WLAN server connections are busy.
SC83	_WLAN_IP_Resolved	ON when WLAN IP Address is assigned
SC84	_WLAN_Connected	ON when WLAN is connected to the access point.
SC86	_WLAN_DHCP_Enabled	ON when WLAN is configured for DHCP.
SC87	_WLAN_DNS_Success	ON when WLAN DNS Lookup was successful.
SC88	_WLAN_DNS_Error	ON when WLAN DNS Lookup was an error.
SC90	_Port_1_Ready_Flag	ON when Port 1 is ready.
SC91	_Port_1_Error_Flag	ON when Port 1 has a communication error.
SC92	_Port_1_Clients_Limit	ON when Port 1 is communicating with 3 clients.
SC93	_Port_1_IP_Resolved	ON when Port 1 obtains an IP address.
SC94	_Port_1_Link_Flag	ON when Port 1 is connected to an Ethernet network.
SC95	_Port_1_100MBIT_Flag	ON when Port 1 is communicating at 100Mbps.

Example Program

The ladder program to use these Receive and Send instructions are easy. You just need one NO (Normally Open) contact instruction to check if the com port is ready to receive or send data.

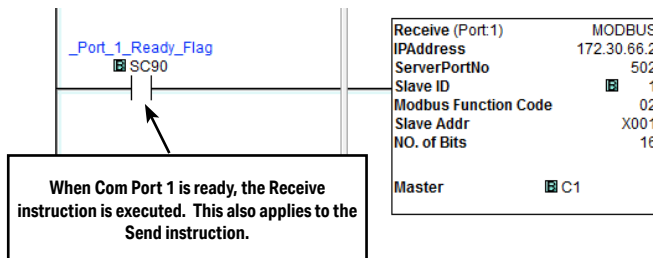

Interlocking

If you are going to use more than one Receive and/or Send instruction with the same server(slave), you need to be sure only one of the instructions is enabled at any point during the operation. The technique to execute more than one Receive and/or Send instructions in order is called 'Interlocking'. When the Interlocking sample program below is executed, one Receive instruction and one Send instruction is executed one-by-one for each server.

Example Program: Interlocking with Two Servers

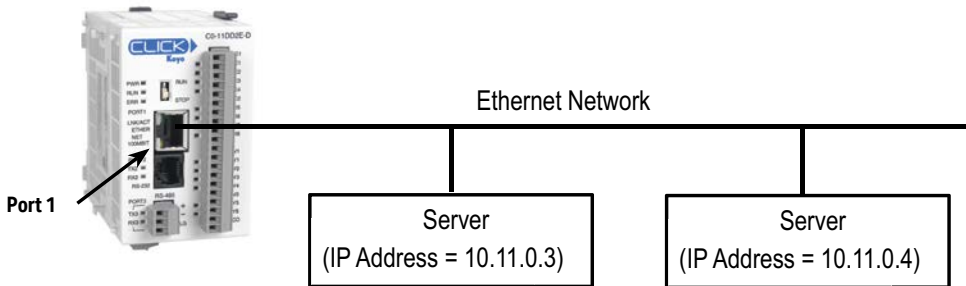

1. Execute the Receive instruction.
2. Execute the Send instruction.

Continue these steps.

1. Execute the Receive instruction.
2. Execute the Send instruction.

Continue these steps.



NOTE: Port 1 can establish the connection with up to 4 servers at the same time.

Chapter 4: PLC Communications

Example Program: Interlocking with a Server (Continued)

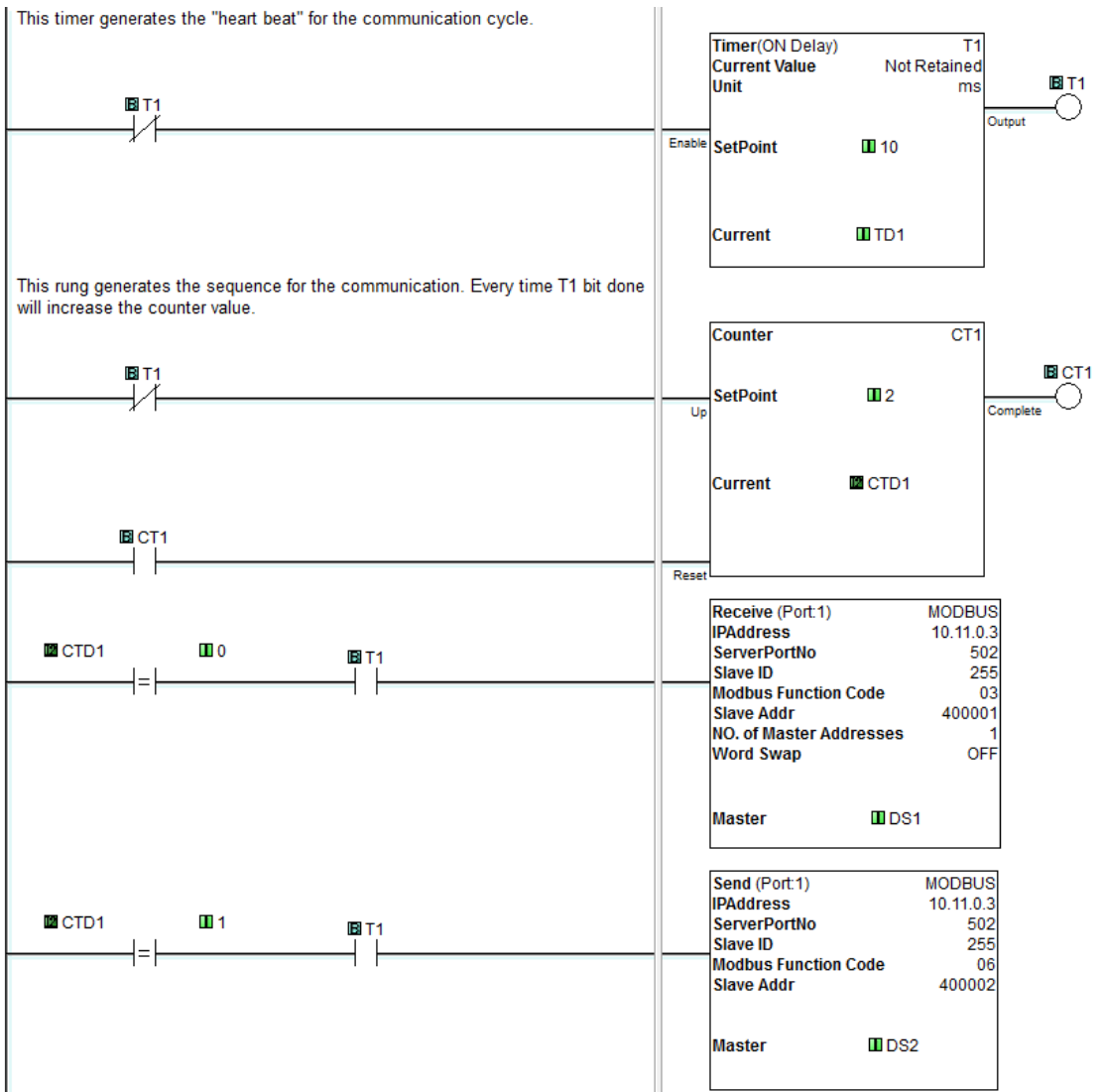

Example Program: Interlocking with a Server (Continued)

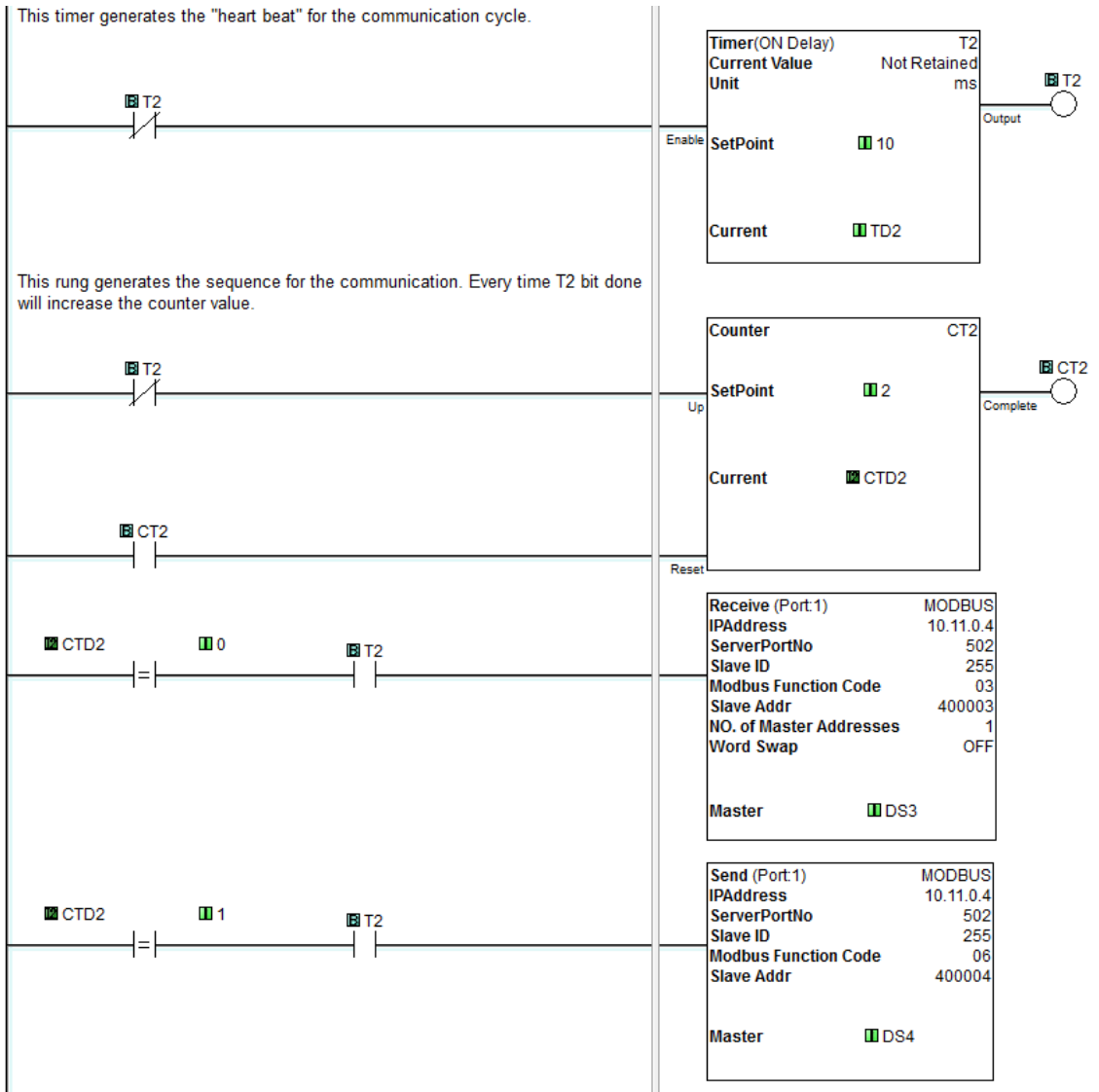

P-4 P-4: ASCII Receive Programming

Instruction

The Receive instruction allows the CLICK PLC to read ASCII message from an external device. To use this instruction, double click Receive in the Instruction List window as shown below.

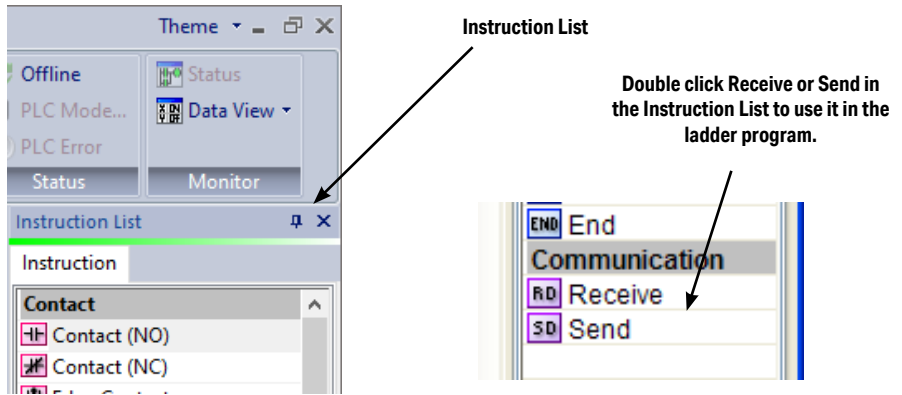

Select the Com Port that you are going to use and confirm the Protocol is ASCII.

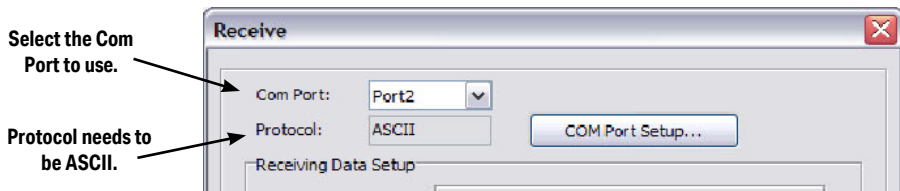

If the Protocol is not ASCII, click the Com Port Setup button to open the Com Port Setup Details window and change the Protocol to ASCII. If the Protocol selection is grayed out as shown below, it means the Com Port is used by another Receive and/or Send instruction in the ladder program. You cannot change the Protocol setup until you delete those instructions.



When you open the Receive instruction in the ASCII mode, the window should look like this. For the explanation of each setup parameter, please click the Help button on the bottom right

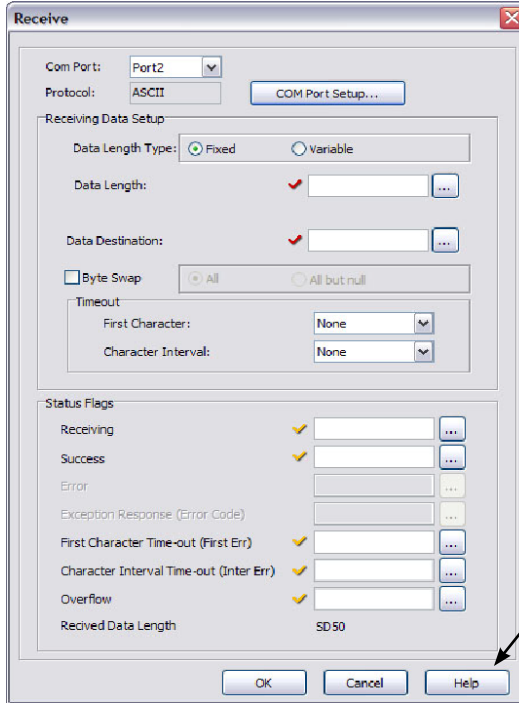

Click the Help button to get the detailed information of this setup window.

Example 1: Read ASCII message from a barcode reader.

With the following example program, when C1 is ON, the Receive instruction is activated and Com Port 2 waits for an ASCII message from the barcode reader. When Com Port 2 receives an ASCII message and it includes the termination character (CR = Carriage Return in this example), C2 is turned on and the received ASCII message is copied to TXT1 address.

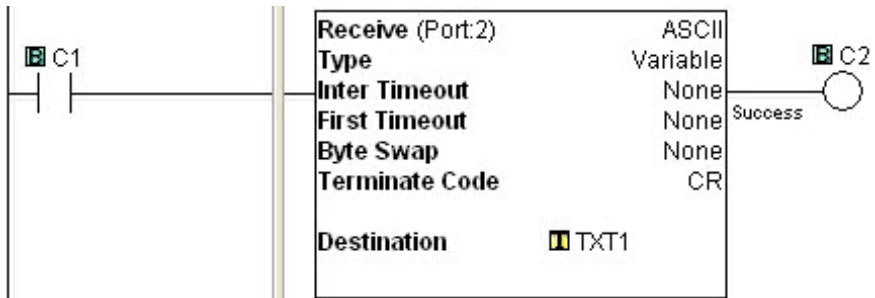

Example 2: Retrieve numerical data from the received ASCII message.

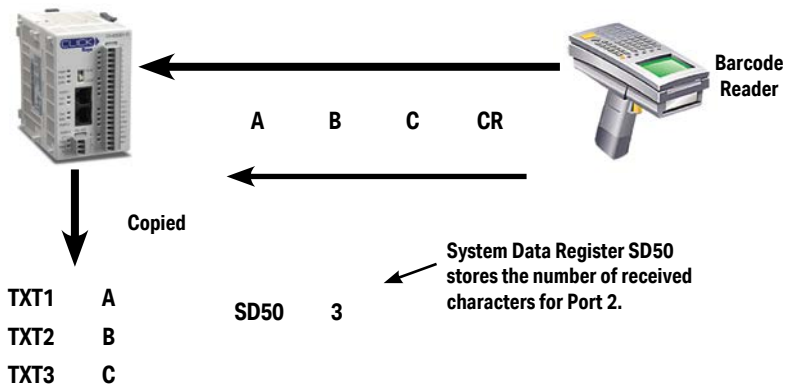

When numerical data is included in the received ASCII message, you may want to retrieve the numerical data and copy into a data register. The Copy instruction can be used for this purpose.

In this example, received ASCII message is stored in TXT1 to TXT6. This ASCII message includes numerical data '1.23' as ASCII characters from TXT3 to TXT6. The Copy instruction converts those ASCII characters into the equivalent numerical data and copies into data register DF1.

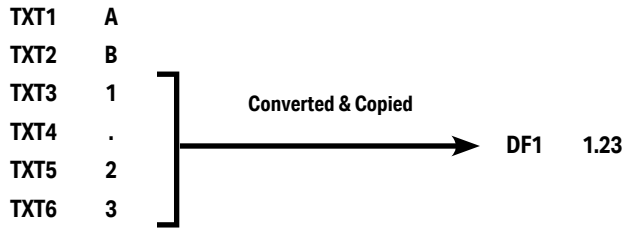
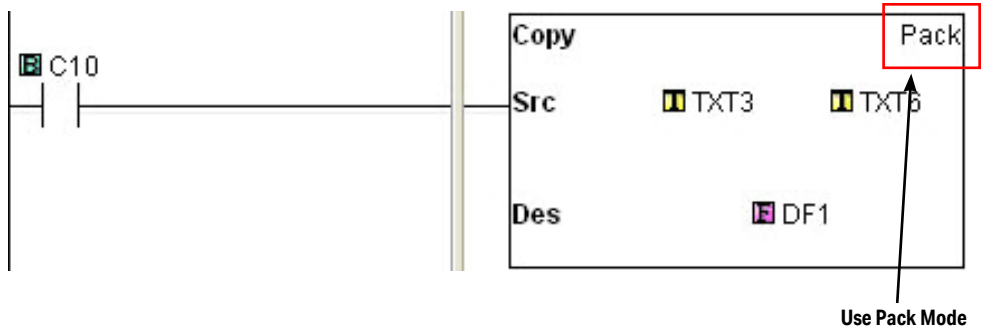

P-5

P-5: ASCII Send Programming

Instruction

The Send instruction allows the CLICK PLC to send ASCII messages to an external device. To use this instruction, double click Send in the Instruction List window as shown below.

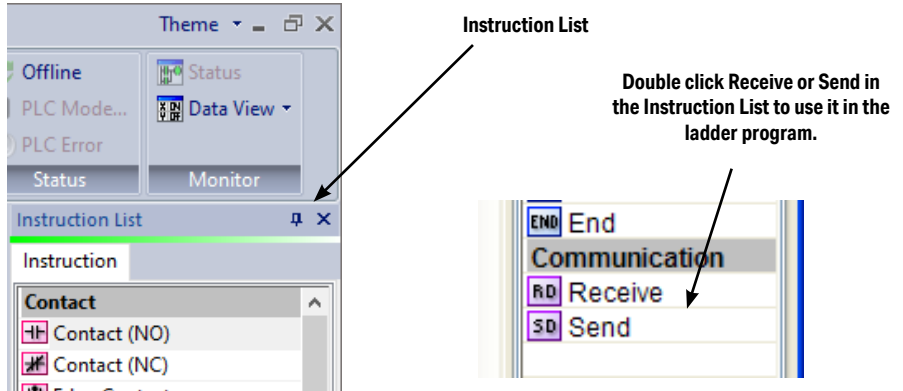

Select the Com Port that you are going to use and confirm the Protocol is ASCII.

If the Protocol is not ASCII, click the Com Port Setup button to open the Com Port Setup

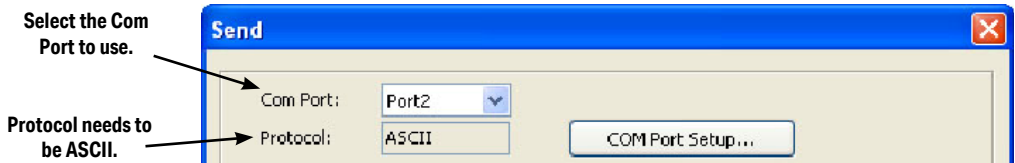

Details window and change the Protocol to ASCII. If the Protocol selection is grayed out as shown below, it means the Com Port is used by another Receive and/or Send instruction the ladder program. You cannot change the Protocol setup until you delete those instructions.



Chapter 4: PLC Communications

When you open the Send instruction in the ASCII mode, the window should look like this. For the explanation of each setup parameter, please click the Help button on the bottom right.

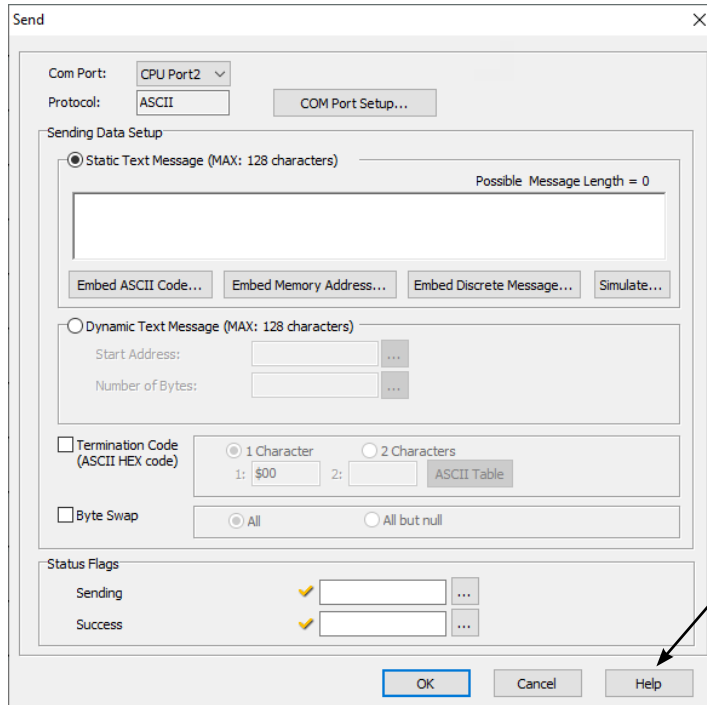

Click the Help button to get detailed information on this setup window.

Example: Send ASCII message to a serial printer.

With the following example program, when status of C1 changes from OFF to ON, the Send instruction sends ASCII message 'ABC' and the termination character (CR = Carriage Return in this example). C2 is turned on when sending the ASCII message is completed.

