

BRX DIGITAL I/O EXPANSION MODULES



In This Chapter...

Overview.....	7-2
Module Types.....	7-3
Wiring Termination Options.....	7-5
General Specifications.....	7-8
Module Installation	7-8
BX-xxNF3 Sinking/Sourcing 3–5 VDC Input	7-9
BX-xxND3 Sinking/Sourcing 12–24 VDC Input.....	7-10
BX-xxNB 12–24 VAC Input	7-13
BX-xxNA 120–240 VAC Input	7-15
BX-08SIM Simulator Input	7-17
BX-xxTD1 Sinking 12–24 VDC Output	7-18
BX-xxTD2 Sourcing 12–24 VDC Output	7-21
BX-16TF2 Sourcing 3–5 VDC Output	7-24
BX-xxTR Relay Output	7-25
BX-xxTRZ Relay Output.....	7-27
BX-05TRS Relay Output	7-28
BX-05TRS-1 Relay Output	7-29
BX-xxTA 120–240 VAC Output	7-30
BX-08CD3R Combination DC Input/Relay Output.....	7-32
BX-xxCD3D1 Combination DC Input/Sinking DC Output.....	7-34
BX-xxCD3D2 Combination DC Input/Sourcing DC Output.....	7-37
BX-16CF3F2 Combination DC Input/DC Sourcing Output.....	7-40

Overview

One key feature of the BRX platform is its ability to expand its capability to fit your application solution. One of the ways the BRX platform can do this is by using expansion modules that conveniently “Snap-on” to the side of any BRX MPU. Once the expansion module has snapped in place it is automatically added to the project and instantly adds additional I/O and features to the MPU with little to no additional setup required.



NOTE: To learn more about adding expansion units to the project, go to [“Installing the Expansion I/O Modules”](#) in Chapter 1.

The digital expansion modules give you the ability to add additional discrete I/O as needed and are identified as an input module, output module or combination input/output module. On the front panel of the digital I/O expansion modules a color scheme and a symbol are used to denote the module type.

Most modules are available in 5, 8, 12, 16 or 32 point variations consisting of sink/source DC inputs/outputs, AC inputs/outputs, relay outputs and combination modules.

The modules ship without wiring terminal blocks. This allows you to select the termination style that best fits your application. There are several wiring options available, including screw terminal connectors, spring clamp terminal connectors and pre-wired **ZIPLink** cable solutions.

More detailed information about the digital expansion modules along with specifications and wiring diagrams follow in this chapter.



NOTE: When using relay expansion modules, adding 32 or more relay points requires you to perform a power budget calculation. See Appendix C for more information.

Module Types

Discrete Input Modules

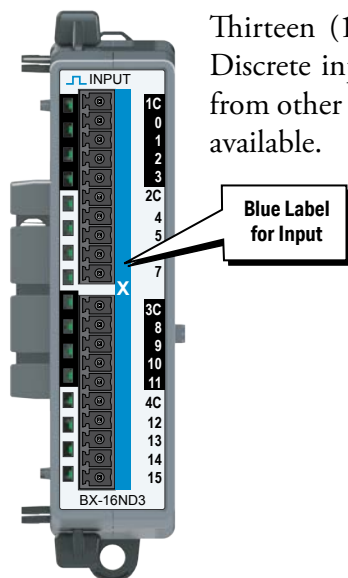

Thirteen (13) discrete input modules are available in various DC and AC voltage ranges. Discrete input module faceplates have a blue terminal bar and symbol  for easy distinction from other module types. Listed in the table below are the five different types of input modules available.

Discrete Input Modules					
Identifier	Type	8-Point	12-Point	16-Point	32-Point
NF3	3–5 VDC Sink/Source	BX-08NF3	N/A	BX-16NF3	N/A
ND3	12–24 VDC Sink/Source	BX-08ND3	BX-12ND3	BX-16ND3	BX-32ND3
NB	24VAC	BX-08NB	BX-12NB	BX-16NB	N/A
NA	120VAC	BX-08NA	BX-12NA	BX-16NA	N/A
SIM	Simulator	BX-08SIM	N/A	N/A	N/A

Discrete Output Modules

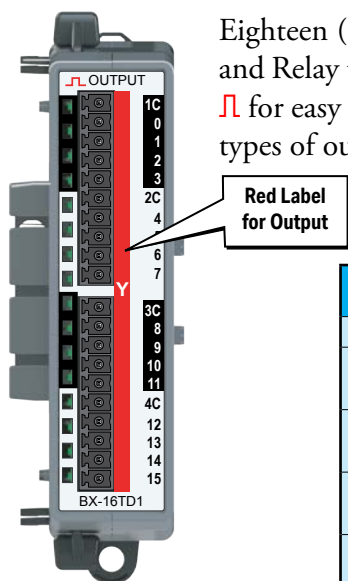

Eighteen (18) discrete output modules are available in DC sinking, DC sourcing, AC voltage and Relay type outputs. Discrete output module faceplates have a red terminal bar and symbol  for easy distinction from other module types. Listed in the table below are the five different types of output modules available.

Discrete Output Modules						
Identifier	Type	5-Point	8-Point	12-Point	16-Point	32-Point
TD1	12–24 VDC Sinking	N/A	BX-08TD1	BX-12TD1	BX-16TD1	BX-32TD1
TD2	12–24 VDC Sourcing	N/A	BX-08TD2	BX-12TD2	BX-16TD2	BX-32TD2
TF2	3–5 VDC Sourcing	N/A	N/A	N/A	BX-16TF2	N/A
TR	Relay Form A (SPST)	N/A	BX-08TR	BX-12TR	BX-16TR	N/A
TRZ	Relay Form A (SPST), no surge suppression	N/A	BX-08TRZ	N/A	BX-16TRZ	N/A
TRS	Relay Form C (SPDT)	BX-05TRS, BX-05TRS-1	N/A	N/A	N/A	N/A
TA	120–240 VAC Triac	N/A	BX-08TA	BX-12TA	N/A	N/A

Module Types, Continued

Discrete Combo Input/Output Modules

Six (6) discrete input/output combo modules are available with DC sink/source inputs and sink/source/relay outputs. The Input/Output faceplate terminal bar is in blue and red, with both the blue \sqcup and red \sqcup symbols to make it easy to distinguish between inputs and outputs and from other module types.

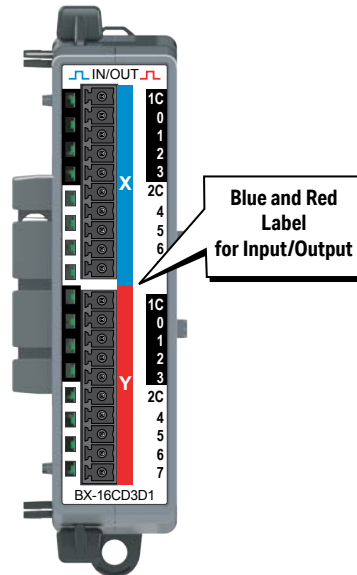

Discrete Combo Input/Output Type						
Identifier	Identifier	Input Type	Output Type	8-Point	12-Point	16-Point
CD3	D1	12–24 VDC Sink/Source	12–24 VDC Sinking	N/A	BX-12CD3D1	BX-16CD3D1
	D2		12–24 VDC Sourcing		BX-12CD3D2	BX-16CD3D2
	R		Relay Form A (SPST)	BX-08CD3R	N/A	N/A
CF3	F2	3–5 VDC Sink/Source	3–5 VDC Sourcing	N/A	N/A	BX-16CF3F2

Wiring Termination Options

The BRX digital expansion modules ship without wiring terminals blocks. This allows you to select the termination style that best fits your application. There are several wiring options available, including removable screw terminal connectors, removable spring clamp terminal connectors and pre-wired **ZIPLink** cable solutions.

Terminal Block Connectors

The terminal block connectors are provided in kits of multiple connectors that are easily ordered as a single part number. There are 2 different types of kits to choose from; one kit for the five, eight and 12-point discrete modules and one kit for the 16-point discrete modules. The five, eight and 12-point module kit includes (3) 5-pin 5mm connectors. The 8-point modules will use only 2 of the 5-pin connectors, one (1) will not be used. The 5 and 12-point modules will use all three connectors. The 16-point module kits include (2) 10-pin 3.81 mm connectors.



NOTE: 32-point modules are not compatible with terminal block connectors and require **ZIPLink** cables.

Terminal block kit part numbers and connector specifications are listed in the following tables.

Terminal Block Connectors, 5-Point, 8-Point & 12-Point Discrete Modules



BX-RTB08 Kit



BX-RTB08-1 Kit

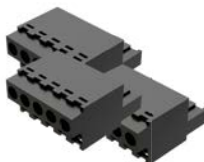

BX-RTB08-2 Kit

Terminal Block Specifications 5, 8 & 12-point Type			
Kit Part Number	BX-RTB08	BX-RTB08-1	BX-RTB08-2
Connector Type	Screw Type - 90 degree	Spring Clamp Type - 180 degree	Screw Type - 180 degree
Wire Exit	180 degree	180 degree	180 degree
Pitch	5.0 mm	5.0 mm	5.0 mm
Screw Size	M2.5	N/A	M2.5
Screw Torque Recommended	< 3.98 lb·in (0.45 N·m)	N/A	< 3.98 lb·in (0.45 N·m)
Screwdriver Blade Width	3.5 mm	3.5 mm	3.5 mm
Wire Gauge (Single Wire)	28–12 AWG	28–14 AWG	28–12 AWG
Wire Gauge (Dual Wire)	28–16 AWG	28–16 AWG (Dual Wire Ferrule Required)	28–16 AWG
Wire Strip Length	0.3 in (7.5 mm)	0.37 in (9.5 mm)	0.3 in (7.5 mm)
Equiv. Dinkle P/N	5ESDV-05P-BK	5ESDSR-05P-BK	5ESDF-05P-BK

Terminal Block Connectors, 16-Point Discrete Modules



BX-RTB10 Kit



BX-RTB10-1 Kit



BX-RTB10-2 Kit

Terminal Block Specifications 16-point			
Part Number	BX-RTB10	BX-RTB10-1	BX-RTB10-2
Connector Type	Screw Type 90 degree	Spring Clamp Type 180 degree	Screw Type 180 degree
Wire Exit	180 degree	180 degree	180 degree
Pitch	3.81 mm	3.81 mm	3.81 mm
Screw Size	M2	N/A	M2
Screw Torque Recommended	<1.77 lb·in (0.2 N·m)	N/A	<1.77 lb·in (0.2 N·m)
Screwdriver Blade Width	2.5 mm	2.5 mm	2.5 mm
Wire Gauge (Single Wire)	28–16 AWG	26–18 AWG	30–16 AWG
Wire Gauge (Dual Wire)	28–18 AWG	30–20 AWG (Dual Wire Ferrule Required)	30–18 AWG
Wire Strip Length	0.24 in (6mm)	0.35 in (9mm)	0.26 in (6.5 mm)
Equiv. Dinkle P/N	EC381V-10P-BK	ESC381V-10-BK	EC381F-10P-BK

ZIPLink Wiring System

BRX digital expansion modules can be quickly connected to convenient **ZIPLink** remote terminal blocks for ease of wiring remote I/O devices. Your **ZIPLink** selection is dependent on the number of expansion module terminal points. The following tables list the connector options.

8-Point BRX Digital Expansion Module ZIPLink Selector					
Expansion Module Part No.	ZIPLink Module	ZIPLink Module Part No.	Qty Needed	ZIPLink Cable Part No.*	Qty Needed
BX-08ND3	Feedthrough	ZL-RTB20, (standard) -OR- ZL-RTB20-1 (compact)	1	ZL-BXEM-CBL10 ZL-BXEM-CBL10-1 ZL-BXEM-CBL10-2	1
BX-08NF3					
BX-08NA					
BX-08NB					
BX-08TD1					
BX-08TD2					
BX-08TR					
BX-08TRZ					
BX-08TA					
BX-08CD3R					

* Select the cable length: Blank = 0.5 m, -1 = 1.0 m, -2 = 2.0 m.
Available pigtail cables: ZL-BXEM-CBL10-1P = 1.0 m, ZL-BXEM-CBL10-2P = 2.0 m.

12 & 5-Point BRX Digital Expansion Module ZIPLink Selector

Expansion Module Part No.	ZIPLink Module	ZIPLink Module Part No.	Qty Needed	ZIPLink Cable Part No.*	Qty Needed
BX-12ND3	Feedthrough	ZL-RTB20 (standard) -OR- ZL-RTB20-1 (compact)	1	ZL-BXEM-CBL15 ZL-BXEM-CBL15-1 ZL-BXEM-CBL15-2	1
BX-12NA					
BX-12NB					
BX-12TD1					
BX-12TD2					
BX-12TR					
BX-05TRS					
BX-12TA					
BX-12CD3D1					
BX-12CD3D2					

*Select the cable length: Blank = 0.5 m, -1 = 1.0 m, -2 = 2.0 m.

Available pigtail cables: ZL-BXEM-CBL15-1P = 1.0 m, ZL-BXEM-CBL15-2P = 2.0 m.

16-Point BRX Digital Expansion Module ZIPLink Selector

Expansion Module Part No.	ZIPLink Module	ZIPLink Module Part No.	Qty Needed	ZIPLink Cable Part No.*	Qty Needed
BX-16ND3	Sensor	ZL-LTB16-24-1	1	ZL-BXEM-CBL20 ZL-BXEM-CBL20-1 ZL-BXEM-CBL20-2	1
	Feedthrough	ZL-RTB20 (standard) -OR- ZL-RTB20-1 (compact)	1		
BX-16NF3	Feedthrough				
BX-16NA	Feedthrough				
BX-16NB	Feedthrough				
BX-16TD1	Relay (Sourcing)	ZL-RRL16-24-1 ZL-RRL16W-24-1 ZL-RRL16F-24-1 ZL-RRL16HDF-24-1	1		
	Relay (Sinking)	ZL-RRL16-24-2 ZL-RRL16W-24-2 ZL-RRL16F-24-2 ZL-RRL16HDF-24-2	1		
		Feedthrough	ZL-RTB20 (standard) -OR- ZL-RTB20-1 (compact)		
BX-16TF2	Feedthrough				
BX-16TR	Feedthrough				
BX-16TRZ	Feedthrough				
BX-16CD3D1	Feedthrough				
BX-16CD3D2	Feedthrough				
BX-16CF3F2	Feedthrough				

*Select the cable length: Blank = 0.5 m, -1 = 1.0 m, -2 = 2.0 m.

Available pigtail cables: ZL-BXEM-CBL20-1P = 1.0 m, ZL-BXEM-CBL20-2P = 2.0 m.

32-Point BRX Digital Expansion Module ZIPLink Selector

Expansion Module Part No.	ZIPLink Module	ZIPLink Module Part No.	Qty Needed	ZIPLink Cable Part No.*	Qty Needed
BX-32ND3	Sensor	ZL-LTB32-24-1	1	ZL-D24-CBL40 ZL-D24-CBL40-1 ZL-D24-CBL40-2	1
	Feedthrough	ZL-RTB40 (standard) -OR- ZL-RTB40-1 (compact)	1		
BX-32TD1	Feedthrough				
BX-32TD2	Feedthrough				

*Select the cable length: Blank = 0.5 m, -1 = 1.0 m, -2 = 2.0 m.

Available pigtail cables: ZL-D24-CBL20-1P = 1.0 m, ZL-D24-CBL20-2P = 2.0 m.

Suffix -X indicates 45° cable connector angle. Non -X indicates 180° cable connector angle.

General Specifications

All BRX digital expansion modules have the same general specifications listed in the table below.

General Specifications	
Operating Temperature	0° to 60°C (32° to 140°F)
Storage Temperature	-20° to 85°C (-4° to 185°F)
Humidity	5 to 95% (non-condensing)
Environmental Air	No corrosive gases permitted
Vibration	IEC60068-2-6 (Test Fc)
Shock	IEC60068-2-27 (Test Ea)
Enclosure Type	Open Equipment
Noise Immunity	NEMA ICS3-304
EU Directive	See the “EU Directive” topic in the Help File
Agency Approvals	UL 61010-2 - UL File # E185989 Canada and USA CE Compliant EN61131-2

Module Installation



WARNING: Do not apply field power until the following steps are completed. The BRX expansion modules are NOT hot swappable.

To install an expansion module, remove the connector cover on the right side of the MPU or expansion module to which the new module is to be connected. Align the expansion connectors, insert the module until you hear a “click”, indicating the module expansion connectors have engaged.

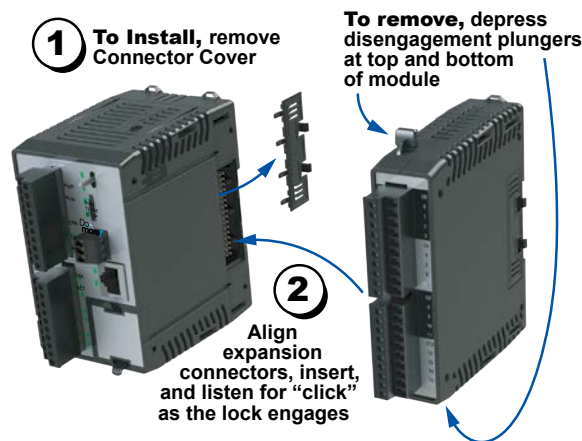

To remove an expansion module locate the two disengagement levers. One is located at the top of the of the expansion module and a second one at the bottom of the expansion module. Firmly drawing the top and bottom disengagement levers forward at the same time will release the locking mechanism and disengage the unit from the system.



NOTE: Allow a minimum of 45mm (1.75 in) to the right of MPU chassis or any subsequent expansion modules for mounting and dismantling of the modules.

BX-xxNF3 Sinking/Sourcing 3–5 VDC Input

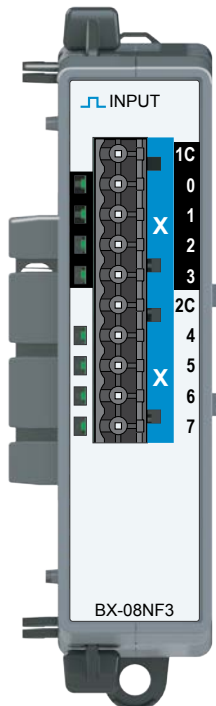

BX-08NF3

Input Module
8-pt, 3–5 VDC
Sink/Source

Terminal Blocks or
ZIPLink Cable
Sold Separately

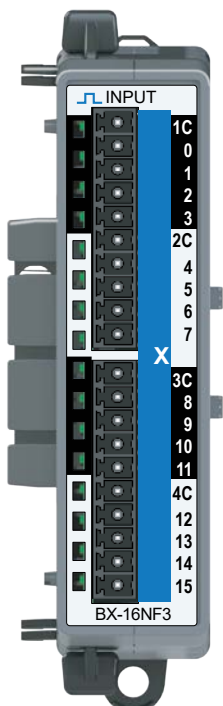

BX-16NF3

Input Module
16-pt, 3–5 VDC
Sink/Source

Terminal Blocks or
ZIPLink Cable
Sold Separately

Discrete Input Specifications		
	BX-08NF3	BX-16NF3
Input Type	Sink/Source	
Inputs per Module	8	16
Commons	2 (4 points/common) Isolated	4 (4 points/common) Isolated
Nominal Voltage Range	3–5 VDC	
Input Voltage Range	2–6 VDC	
Maximum Voltage	6VDC	
Input Impedance	870Ω @ 5VDC	
Input Current (typical)	6mA @ 5VDC	
Maximum Input Current	8mA @ 6VDC	
Heat Dissipation	0.6 W Max	1.1 W Max
ON Voltage Level	> 2.0 VDC	
OFF Voltage Level	< 0.8 VDC	
Minimum ON Current	1.2 mA (2V required-guarantee ON state)	
Maximum OFF Current	0.5 mA	
OFF-ON Response	2ms	
ON-OFF Response	2ms	
Status Indicators	Logic Side, Green	
Software Version Required	Do-more! Designer version 2.0 or later	Do-more! Designer version 2.8 or later

We recommend using prewired ZIPLink cables and connection modules. If you wish to hand-wire your module, a removable terminal block is available. See Wiring Termination Selection in this chapter for all options.



IMPORTANT!



Hot-Swapping Information

Note: This device cannot be Hot Swapped.

Discrete Input Wiring Diagrams

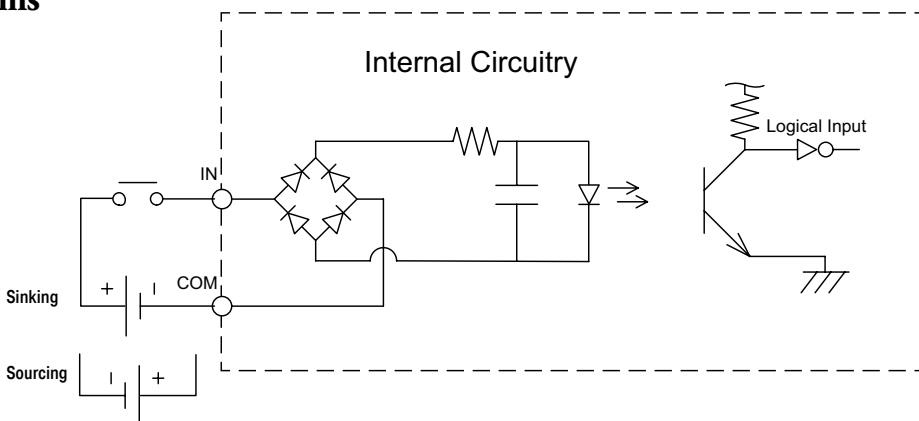
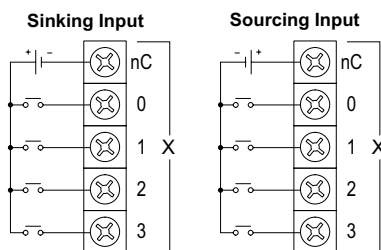

BX-xxND3 Sinking/Sourcing 12–24 VDC Input

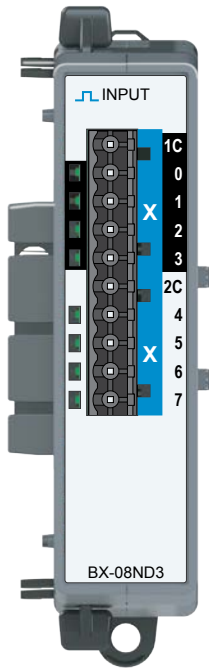

BX-08ND3

Input Module
8-pt, 12–24 VDC
Sink/Source

Terminal Blocks or
ZIPLink Cable
Sold Separately

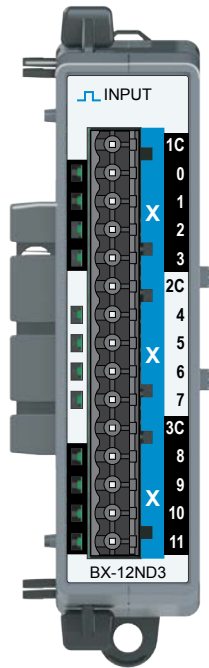

BX-12ND3

Input Module
12-pt, 12–24 VDC
Sink/Source

Terminal Blocks or
ZIPLink Cable
Sold Separately

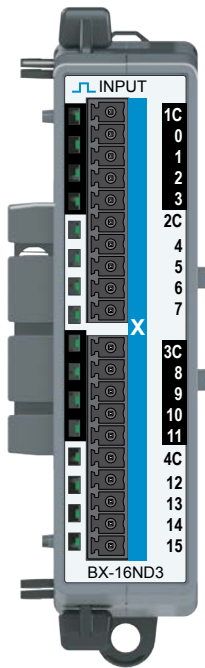

BX-16ND3

Input Module
16-pt, 12–24 VDC
Sink/Source

Terminal Blocks or
ZIPLink Cable
Sold Separately

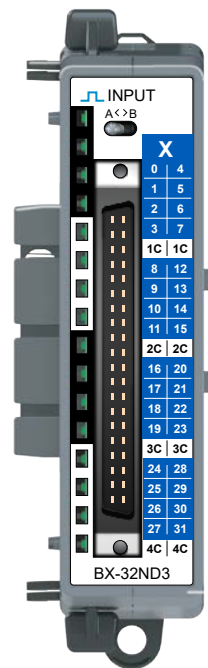

BX-32ND3

Input Module
32-pt, 12–24 VDC
Sink/Source

ZIPLink Cable
Sold Separately

We recommend using prewired ZIPLink cables and connection modules. See Wiring Termination Selection in this chapter for all options.



IMPORTANT!



Hot-Swapping Information

Note: This device cannot be Hot Swapped.

BX-xxND3 Sinking/Sourcing 12–24 VDC Input, continued

Discrete Input Specifications				
	BX-08ND3	BX-12ND3	BX-16ND3	BX-32ND3
Input Type	Sink/Source			
Inputs per Module	8	12	16	32
Commons (Isolated)	2	3	4	4
Points per Common	4	4	4	8
Nominal Voltage Range	12–24 VDC			
Input Voltage Range	9–30 VDC			
Maximum Voltage	30VDC			
Input Impedance	3k Ω @ 24VDC			8k Ω @ 24VDC
Input Current (typical)	8mA @ 24VDC			3mA @ 24VDC
Maximum Input Current	12mA @ 30VDC			6mA @ 30VDC
Heat Dissipation	3.1 W Max	4.7 W Max	6.1 W Max	6.2 W Max
ON Voltage Level	> 9.0 VDC			> 9.0 VDC
OFF Voltage Level	< 2.0 VDC			< 2.0 VDC
Minimum ON Current	5.0 mA (9V required to guarantee ON state)			3.0 mA (9V required to guarantee ON state)
Maximum OFF Current	2.0 mA			1.5 mA
OFF-ON Response	2ms			
ON-OFF Response	2ms			
Status Indicators	Logic Side, Green (32-point module has 16 LEDs for half of inputs, switchable via A/B switch)			
Software Version Required	Do-more! Designer version 2.0 or later			Do-more! Designer version 2.3 or later

Discrete Input Wiring Diagrams for 8, 12 and 16-point modules

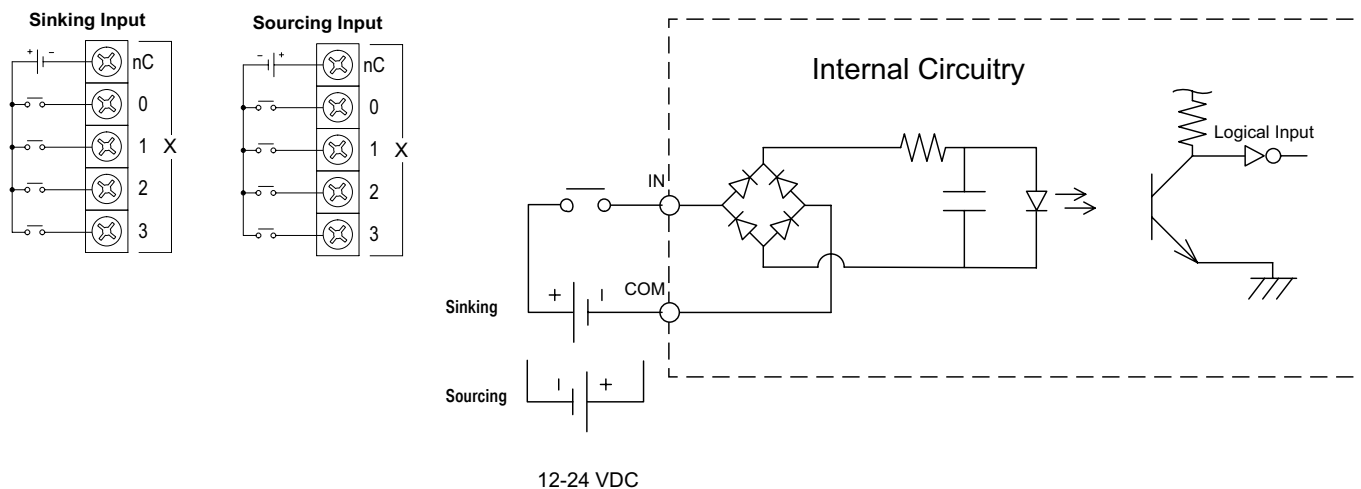

BX-xxND3 Sinking/Sourcing 12–24 VDC Input, continued

Discrete Input Wiring Diagrams, 32-point module

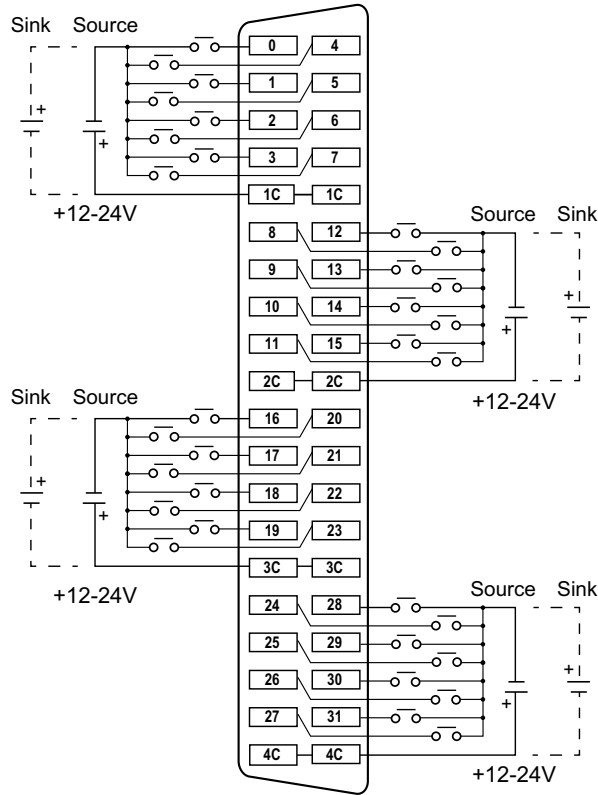

BX-xxNB 12–24 VAC Input

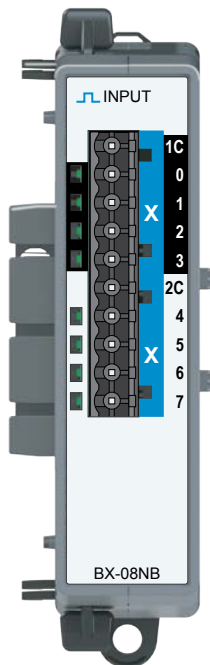

BX-08NB

Input Module
8-pt, 12–24 VAC

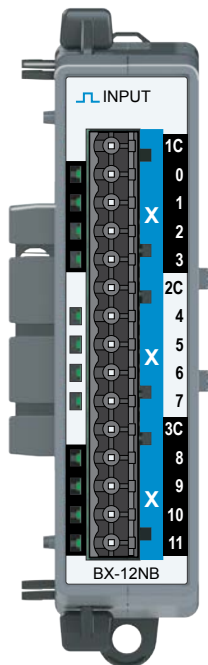

BX-12NB

Input Module
12-pt, 12–24 VAC

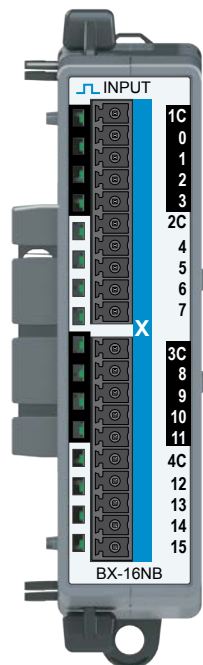

BX-16NB

Input Module
16-pt, 12–24 VAC



Terminal Blocks or
ZIPLink Cables Sold
Separately

We recommend using prewired ZIPLink cables and connection modules. If you wish to hand-wire your module, a removable terminal block is available. See Wiring Termination Selection in this chapter for all options.



IMPORTANT!



Hot-Swapping Information

Note: This device cannot be Hot Swapped.

BX-xxNB 12–24 VAC Input, continued

Discrete Input Specifications			
	BX-08NB	BX-12NB	BX-16NB
Input Type	AC		
Inputs per Module	8	12	16
Commons	2 (4pts / common) Isolated	3 (4pts / common) Isolated	4 (4pts / common) Isolated
Nominal Voltage Range	12–24 VAC		
Input Voltage Range	9–30 VAC		
Maximum Voltage	30VAC RMS		
AC Frequency	47–63 Hz		
Input Impedance	3kΩ @ 24VAC		
Input Current (typical)	8mA @ 24VAC		
Maximum Input Current	12mA @ 30VAC		
Heat Dissipation	3.1 W Max	4.7 W Max	6.1 W Max
ON Voltage Level	> 9.0 VAC		
OFF Voltage Level	< 2.0 VAC		
Minimum ON Current	5.0 mA (9V required-guarantee ON state)		
Maximum OFF Current	2.0 mA		
OFF-ON Response	10ms		
ON-OFF Response	10ms		
Status Indicators	Logic Side, Green		
Software Version Required	Do-more! Designer version 2.0 or later		

Discrete Input Wiring Diagram

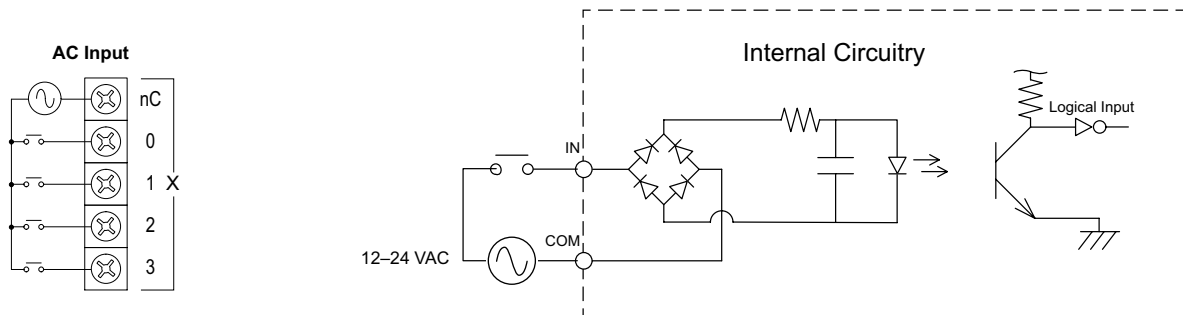

BX-xxNA 120–240 VAC Input

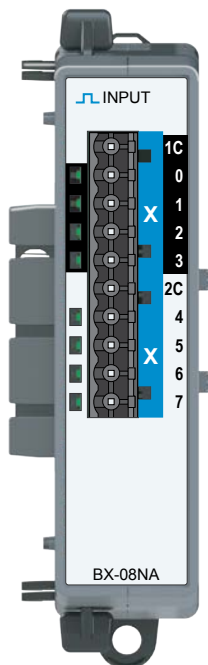

BX-08NA
Input Module
8-pt, 120–240 VAC

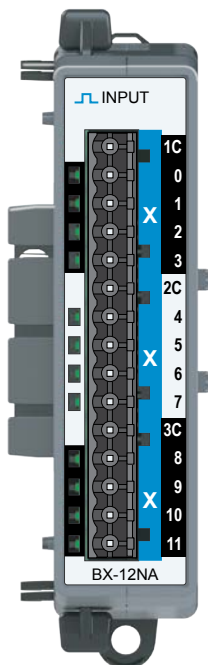

BX-12NA
Input Module
12-pt, 120–240 VAC

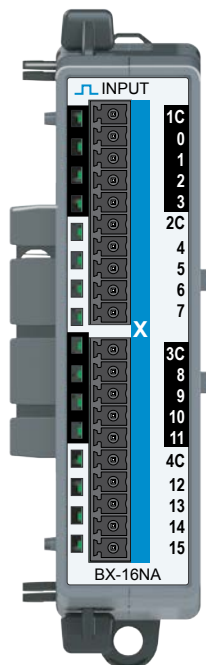

BX-16NA
Input Module
16-pt, 120–240 VAC



Terminal Blocks or
ZIPLink Cables Sold
Separately

We recommend using prewired ZIPLink cables and connection modules. If you wish to hand-wire your module, a removable terminal block is available. See Wiring Termination Selection in this chapter for all options.



IMPORTANT!



Hot-Swapping Information

Note: This device cannot be Hot Swapped.

BX-xxNA 120–240 VAC Input, continued

Discrete Input Specifications			
	BX-08NA	BX-12NA	BX-16NA
Input Type	AC		
Inputs per Module	8	12	16
Commons	2 (4pts / common) Isolated	3 (4pts / common) Isolated	4 (4pts / common) Isolated
Nominal Voltage Range	120–240 VAC		
Input Voltage Range	85–264 VAC		
Maximum Voltage	264VAC RMS		
AC Frequency	47–63 Hz		
Input Impedance	15k Ω		
Input Current (typical)	9mA @ 120VAC, 13mA @ 220VAC		
Maximum Input Current	14mA @ 120VAC, 20mA @ 220VAC		
Heat Dissipation	2.8 W Max	4.2 W Max	5.5 W Max
ON Voltage Level	> 85VAC		
OFF Voltage Level	< 40VAC		
Maximum OFF Current	2.5 mA		
OFF-ON Response	10ms		
ON-OFF Response	10ms		
Status Indicators	Logic Side, Green		
Software Version Required	Do-more! Designer version 2.0 or later		

Discrete Input Wiring Diagram

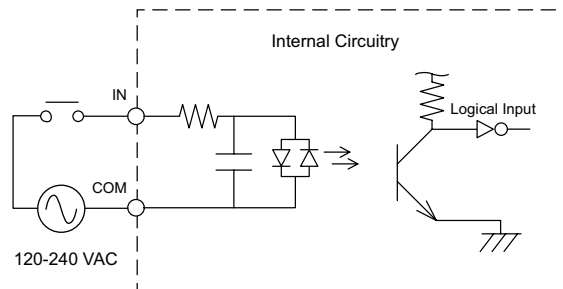
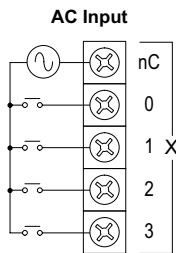

BX-08SIM Simulator Input

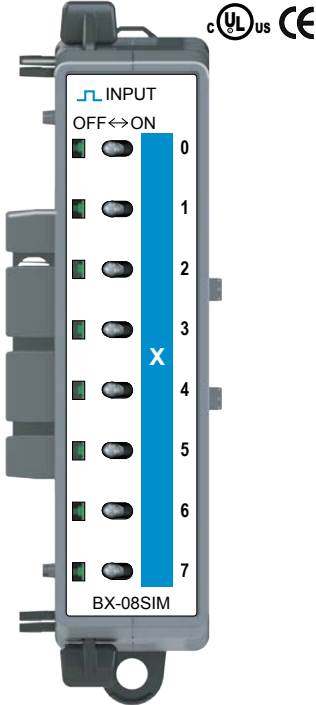

Discrete Input Specifications	
Input Type	Simulator
Inputs per Module	8
Heat Dissipation	0.2 W Max
Status Indicators	Logic Side, Green
Software Version Required	Do-more! Designer version 2.3 or later

IMPORTANT!



Hot-Swapping Information
Note: This device cannot be Hot Swapped.

BX-xxTD1 Sinking 12–24 VDC Output

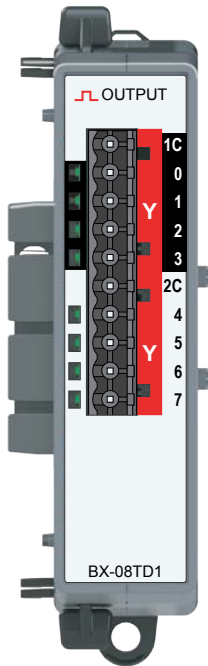

BX-08TD1

Output Module
8-pt, 12–24 VDC
Sinking

Terminal Blocks or
ZIPLink Cable
Sold Separately

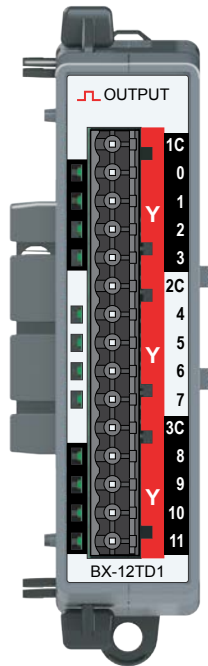

BX-12TD1

Output Module
12-pt, 12–24 VDC
Sinking

Terminal Blocks or
ZIPLink Cable
Sold Separately

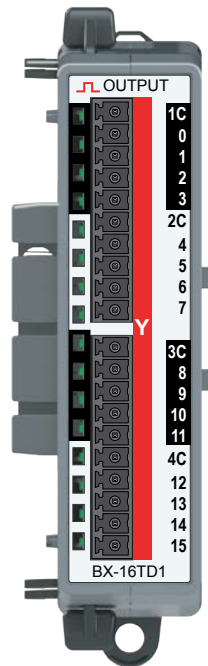

BX-16TD1

Output Module
16-pt, 12–24 VDC
Sinking

Terminal Blocks or
ZIPLink Cable
Sold Separately

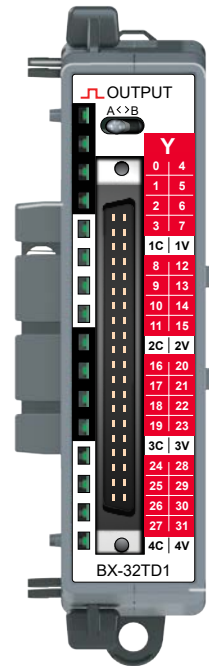

BX-32TD1

Output Module
32-pt, 12–24 VDC
Sinking

ZIPLink Cable
Sold Separately

We recommend using prewired ZIPLink cables and connection modules. See Wiring Termination Selection in this chapter for all options.



IMPORTANT!



Hot-Swapping Information

Note: This device cannot be Hot Swapped.

BX-xxTD1 Sinking 12–24 VDC Output, continued

Discrete Output Specifications				
	BX-08TD1	BX-12TD1	BX-16TD1	BX-32TD1
Output Type	Sinking			
Outputs per Module	8	12	16	32
Commons (Isolated)	2	3	4	4
Points per Common	4	4	4	8
Maximum Current per Common	2A			
Nominal Voltage Range	12–24 VDC			
Operating Voltage Range	5–36 VDC			
Maximum Voltage	36VDC			
Minimum Output Current	0.1 mA @ 24VDC			
Maximum Output (Load) Current	0.5 A per output, no derating over temperature range			
Maximum Inrush Current	5A for 50ms			
Maximum Leakage Current	10 μ A			
Heat Dissipation	1.0 W Max	1.4 W Max	1.6 W Max	3.2 W Max
ON Voltage Drop	0.05 VDC			
OFF-ON Response	< 5ms			
ON-OFF Response	< 2ms			
Maximum Switching Frequency	143Hz			
Overcurrent Protection	N/A			
Fuse Type	User-supplied external fuse			
Status Indicators	Logic Side, Green (32-point module has 16 LEDs for half of outputs, selectable via A/B switch)			
Software Version Required	Do-more! Designer version 2.0 or later			Do-more! Designer version 2.3 or later

Discrete Output Wiring Diagram for 8, 12 and 16-point modules

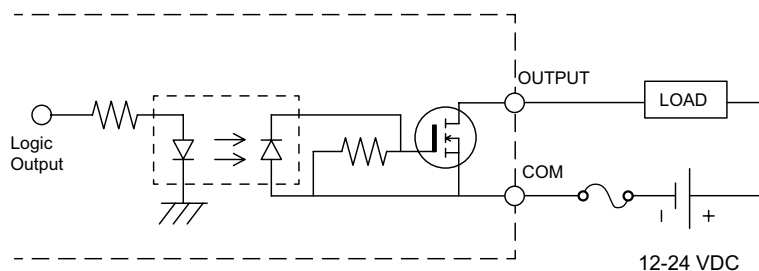
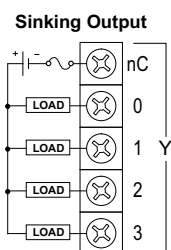

BX-xxTD1 Sinking 12–24 VDC Output, continued

Discrete Output Wiring Diagrams, 32-point module

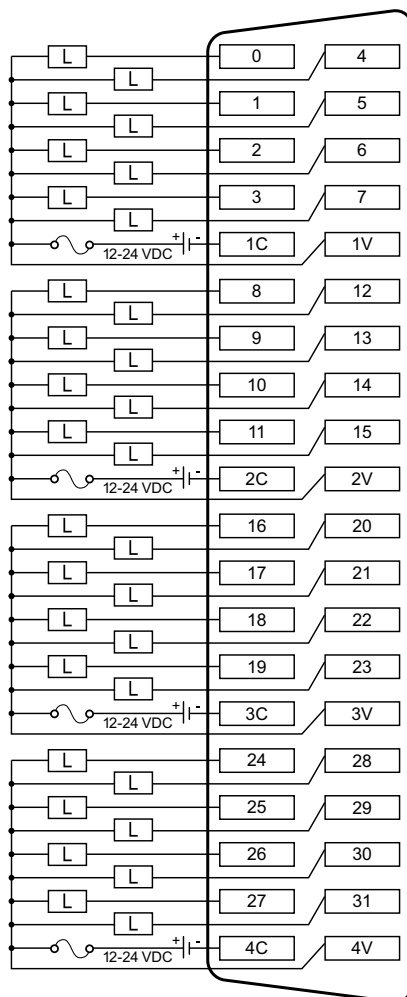

BX-xxTD2 Sourcing 12–24 VDC Output

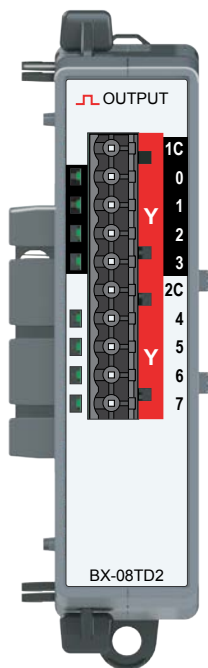

BX-08TD2

Output Module
8-pt, 12–24 VDC
Sourcing

Terminal Blocks or
ZIPLink Cable
Sold Separately

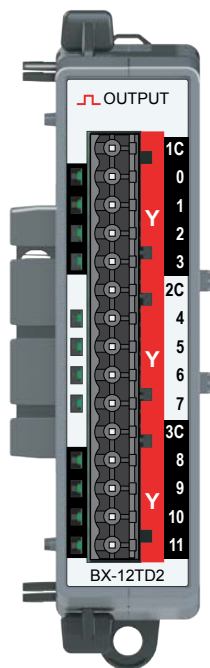

BX-12TD2

Output Module
12-pt, 12–24 VDC
Sourcing

Terminal Blocks or
ZIPLink Cable
Sold Separately

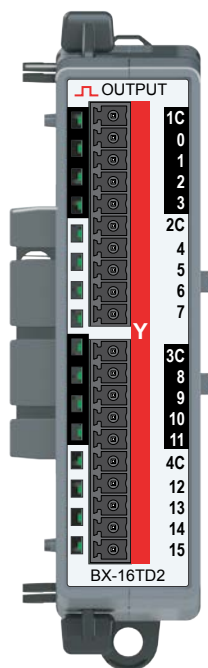

BX-16TD2

Output Module
16-pt, 12–24 VDC
Sourcing

Terminal Blocks or
ZIPLink Cable
Sold Separately

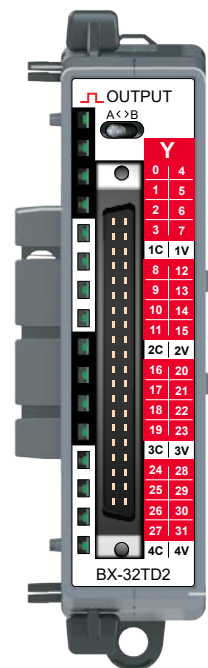

BX-32TD2

Output Module
32-pt, 12–24 VDC
Sourcing

ZIPLink Cable
Sold Separately

We recommend using prewired ZIPLink cables and connection modules. See Wiring Termination Selection in this chapter for all options.



IMPORTANT!



Hot-Swapping Information

Note: This device cannot be Hot Swapped.

BX-xxTD2 Sourcing 12–24 VDC Output, continued

Discrete Output Specifications				
	BX-08TD2	BX-12TD2	BX-16TD2	BX-32TD2
Output Type	Sourcing			
Outputs per Module	8	12	16	32
Commons (Isolated)	2	3	4	4
Points per Common	4	4	4	8
Maximum Current per Common	2A			
Nominal Voltage Range	12–24 VDC			
Operating Voltage Range	5–36 VDC			
Maximum Voltage	36VDC			
Minimum Output Current	0.1 mA @ 24VDC			
Maximum Output (Load) Current	0.5 A per output, no derating over temperature range			
Maximum Inrush Current	5A for 50ms			
Maximum Leakage Current	10 μ A			
Heat Dissipation	1.0 W Max	1.4 W Max	1.6 W Max	3.2 W Max
ON Voltage Drop	0.05 VDC			
OFF-ON Response	< 5ms			
ON-OFF Response	< 2ms			
Maximum Switching Frequency	143Hz			
Overcurrent Protection	N/A			
Fuse Type	User-supplied external fuse			
Status Indicators	Logic Side, Green (32-point module has 16 LEDs for half of outputs, selectable via A/B switch)			
Software Version Required	Do-more! Designer version 2.0 or later			Do-more! Designer version 2.3 or later

Discrete Output Wiring Diagram for 8, 12 and 16-point modules

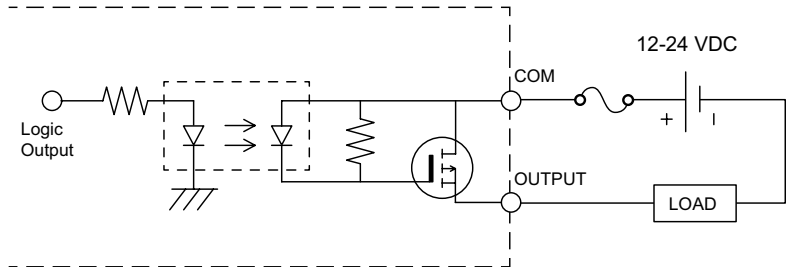
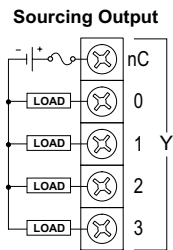

BX-xxTD2 Sourcing 12–24 VDC Output, continued

Discrete Output Wiring Diagrams, 32-point module

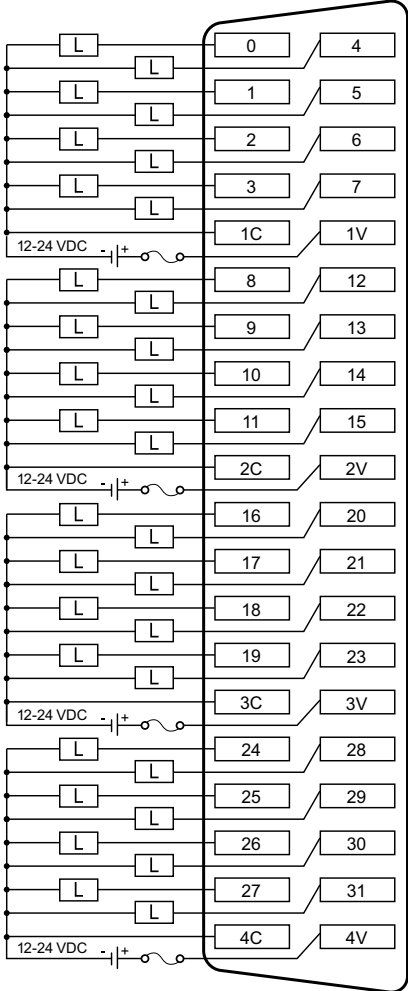

BX-16TF2 Sourcing 3–5 VDC Output

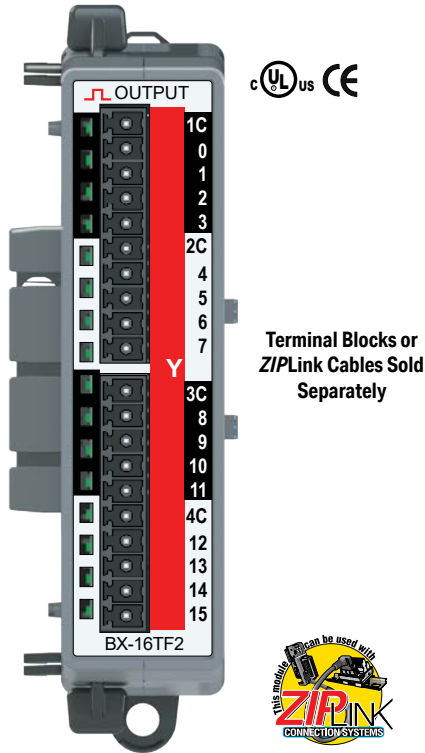

Discrete Output Specifications	
Output Type	Sourcing
Outputs per Module	16
Commons	4
Maximum Current per Common	96mA
Power Supply	Internal +5VDC
Peak Voltage	5.5 VDC
Minimum Output Current	0 μ A
Maximum Output Current	24mA per output, no derating over temperature range
Maximum Leakage Current	10 μ A
Heat Dissipation	1.2 W Max
ON Voltage Drop	0.05 VDC
ON-OFF Response	<2ms
OFF-ON Response	<5ms
Fuses, Overcurrent Protection	N/A
Backplane Power Consumption	0.9 W
Status Indicators	Logic Side, Green
Software Version Required	Do-more! Designer version 2.8 or later

We recommend using prewired ZIPLink cables and connection modules. If you wish to hand-wire your module, a removable terminal block is available. See Wiring Termination Selection in this chapter for all options.

IMPORTANT!



Hot-Swapping Information

Note: This device cannot be Hot Swapped.

Discrete Output Wiring Diagram

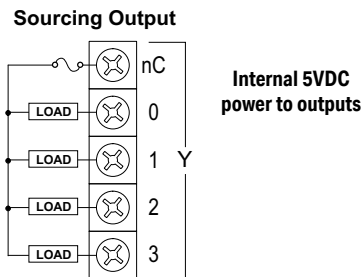

BX-xxTR Relay Output

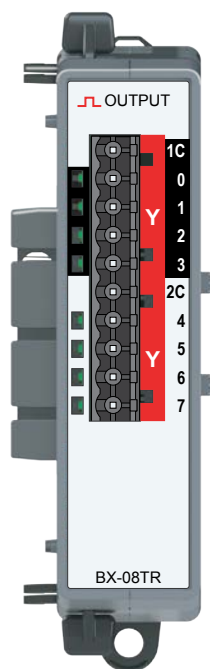

BX-08TR

Output Module 8-pt,
Relay Form A (SPST)

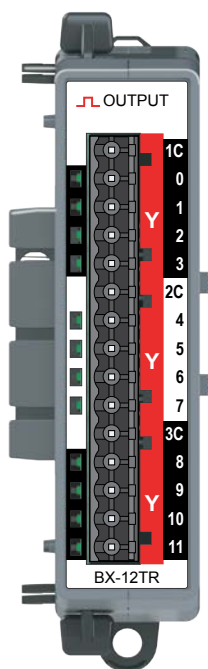

BX-12TR

Output Module 12-pt,
Relay Form A (SPST)

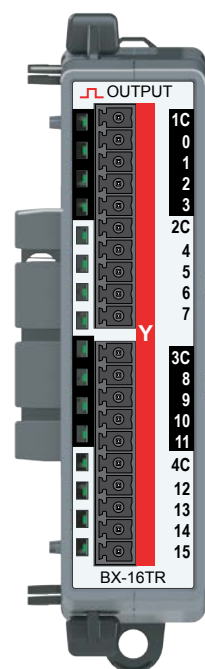

BX-16TR

Output Module 16-pt,
Relay Form A (SPST)

Terminal Blocks or
ZIPLink Cables Sold
Separately

We recommend using prewired ZIPLink cables and connection modules.

If you wish to hand-wire your module, a removable terminal block is available. See Wiring Termination Selection in this chapter for all options.



IMPORTANT!



Hot-Swapping Information

Note: This device cannot be Hot Swapped.



NOTE: When using relay expansion modules, adding 32 or more relay points requires you to perform a power budget calculation. See Appendix C for more information.

BX-xxTR Relay Output, continued

Discrete Output Specifications			
	BX-08TR	BX-08TR	BX-16TR
Output Type	Relay, Form A (SPST)		
Outputs per Module	8	12	16
Commons	2 (4pts / common) Isolated	3 (4pts / common) Isolated	4 (4pts / common) Isolated
Surge Suppression	Yes		
Maximum Current per Common	8A		
Nominal Voltage Range	12–48 VDC 24–240 VAC		
Operating Voltage Range	5–60 VDC 5–264 VAC		
Maximum Voltage	60VDC, 264VAC		
Minimum Output Current	0.1 mA @ 24V AC/DC		
Maximum Output Current	2A		
Maximum Inrush Current	5A for 50ms		
Maximum Leakage Current	1µA (DC), 300µA (AC) due to RC snubber circuit		
Heat Dissipation	4.9 W Max	7.3 W Max	9.8 W Max
ON Voltage Drop	> 0.2 Vmax		
Fuse Type	User-supplied external fuse		
Maximum Switching Frequency	10Hz		
Relay Cycle Life Mechanical Endurance Electrical Endurance	5 Million Operations 120,000 Operations		
Status Indicators	Logic Side, Green		
Software Version Required	Do-more! Designer version 2.0 or later		

Relay Output Wiring Diagram

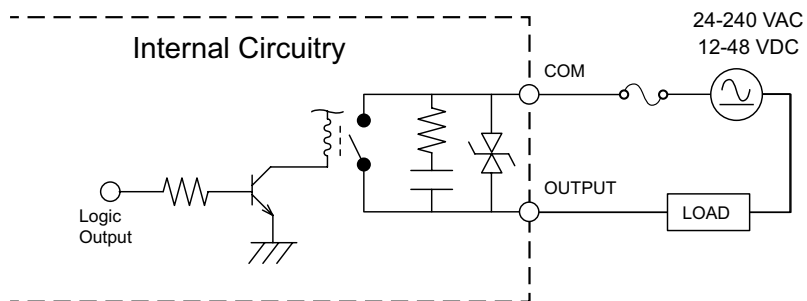
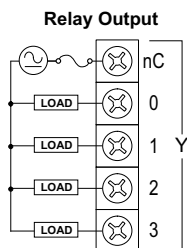

BX-xxTRZ Relay Output

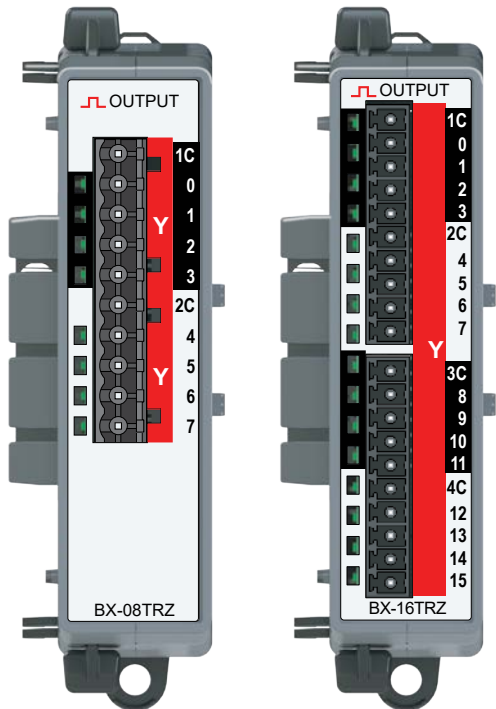

BX-08TRZ

Output Module 8-pt,
Relay Form A (SPST)
No surge suppression

**Terminal Blocks or
ZIPLink Cable
Sold Separately**

BX-16TRZ

Output Module 16-pt,
Relay Form A (SPST)
No surge suppression

**Terminal Blocks or
ZIPLink Cable
Sold Separately**

Discrete Output Specifications		
	BX-08TRZ	BX-16TRZ
Output Type	Relay, Form A (SPST)	
Outputs per Module	8	16
Commons	2 (4pts / common) Isolated	4 (4pts / common) Isolated
Surge Suppression	No	
Maximum Current per Common	8A	
Nominal Voltage Range	5–48 VDC, 24–240 VAC	
Operating Voltage Range	5–60 VDC, 18–264 VAC	
Maximum Voltage	60VDC, 264VAC	
Minimum Output Current	0.1 mA @ 24VDC	
Maximum Output Current	2A	
Maximum Inrush Current	5A for 50ms	
Maximum Leakage Current	1nA	
Heat Dissipation	4.9 W Max	9.8 W Max
Backplane Power Consumption	1.7 W	3.4 W
ON Voltage Drop	0.2 Vmax	
Relay Cycle Life	5 Million Operations	
Mechanical Endurance	120,000 Operations	
Electrical Endurance		
Status Indicators	Logic Side, Green	
Software Version Required	Do-more! Designer version 2.8 or later	

We recommend using prewired ZIPLink cables and connection modules. If you wish to hand-wire your module, a removable terminal block is available. See Wiring Termination Selection in this chapter for all options.



IMPORTANT!



Hot-Swapping Information

Note: This device cannot be Hot Swapped.

Relay Output Wiring Diagram

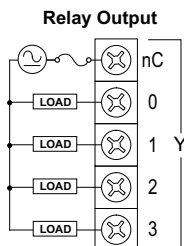

BX-05TRS Relay Output

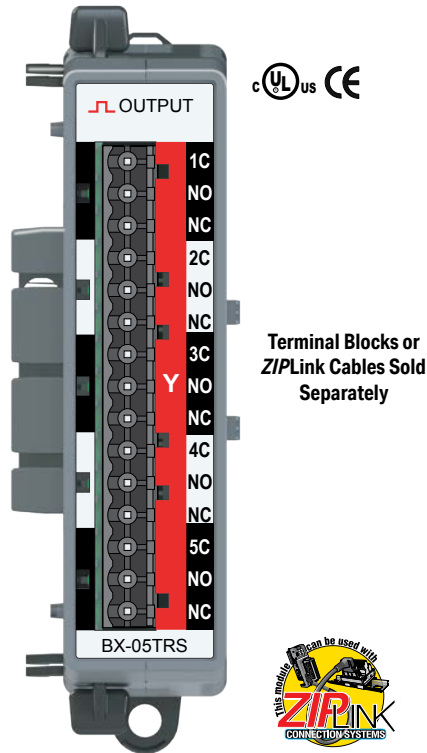

Terminal Blocks or ZIPLink Cables Sold Separately

We recommend using prewired ZIPLink cables and connection modules. If you wish to hand-wire your module, a removable terminal block is available. See Wiring Termination Selection in this chapter for all options.

Discrete Output Specifications	
Output Type	Relay, Form C (SPDT)
Outputs per Module	5
Commons	5 Isolated
Maximum Current per Common	2A
Nominal Voltage Range	12–48 VDC 24–240 VAC
Operating Voltage Range	5–60 VDC 5–264 VAC
Maximum Voltage	60VDC, 264VAC
Minimum Output Current	0.1 mA @ 24V AC/DC
Maximum Output Current	2A
Maximum Inrush Current	5A for 50ms
Maximum Leakage Current	1µA (DC), 300µA (AC) due to RC snubber circuit
Heat Dissipation	3.8 W Max
ON Voltage Drop	> 0.2 Vmax
ON-OFF Response	<10ms
OFF-ON Response	<10ms
Fuse Type	User-supplied external fuse
Maximum Switching Frequency	10Hz
Relay Cycle Life	
Mechanical Endurance	10 Million Operations
Electrical Endurance	50,000 Operations
Status Indicators	Logic Side, Green
Software Version Required	Do-more! Designer version 2.0 or later

IMPORTANT!



Hot-Swapping Information

Note: This device cannot be Hot Swapped.



NOTE: When using relay expansion modules, adding 32 or more relay points requires you to perform a power budget calculation. See Appendix C for more information.

Relay Output Wiring Diagram

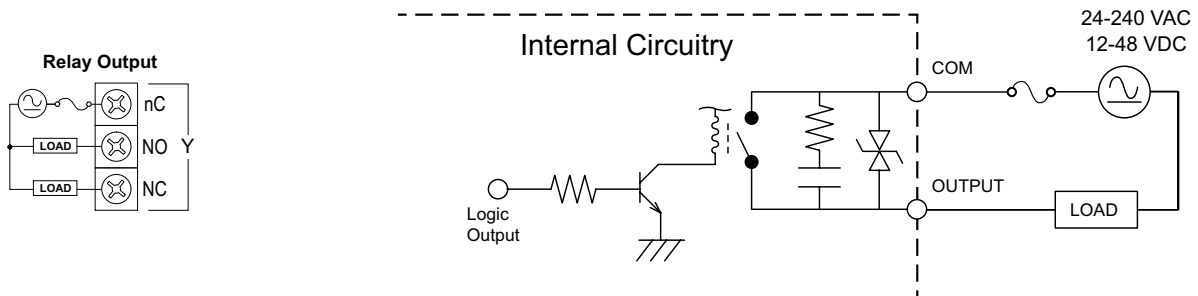

BX-05TRS-1 Relay Output

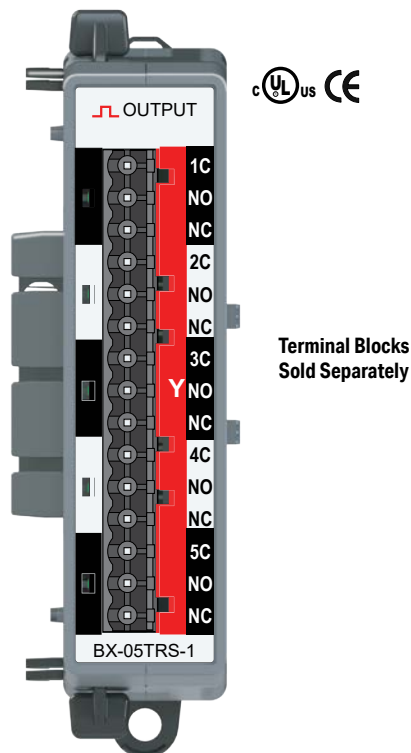

Terminal Blocks
Sold Separately



NOTE: This device does not support ZIPLink Wiring Systems.

IMPORTANT!



Hot-Swapping Information

Note: This device cannot be Hot Swapped.

Discrete Output Specifications	
Output Type	Relay, Form C (SPDT)
Outputs per Module	5
Commons	5 Isolated
Maximum Current per Common	8A
Nominal Voltage Range	5–48 VDC, 24–240 VAC
Operating Voltage Range	5–120 VDC, 18–264 VAC
Peak Voltage	120VDC, 264VAC
Minimum Output Current	0.1 mA @ 24VDC
Maximum Output Current	
@30VDC Resistive Load	8A
@50VDC Resistive Load	3A
@120VDC Resistive Load	0.5 A
@120VAC Resistive Load	8A
@240VAC Resistive Load	5A
@120VAC Inductive 0.4 Power Factor	5A
@240VAC Inductive 0.4 Power Factor	2A
Maximum Inrush Current	15A for 50ms
Maximum Leakage Current	10µA
Heat Dissipation	308W Max
Backplane Power Consumption	1.8 W Max
ON Voltage Drop	0.2 Vmax
ON-OFF Response	<10ms
OFF-ON Response	<10ms
Fuse Type	N/A
Maximum Switching Frequency	10Hz
Relay Cycle Life	
Mechanical Endurance	5 Million Operations
Electrical Endurance	120,000 Operations
Status Indicators	Logic Side, Green
Software Version Required	Do-more! Designer version 2.8 or later



NOTE: When using relay expansion modules, adding 32 or more relay points requires you to perform a power budget calculation. See Appendix C for more information.

Relay Output Wiring Diagram

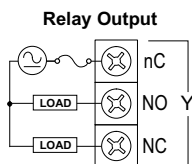

BX-xxTA 120–240 VAC Output

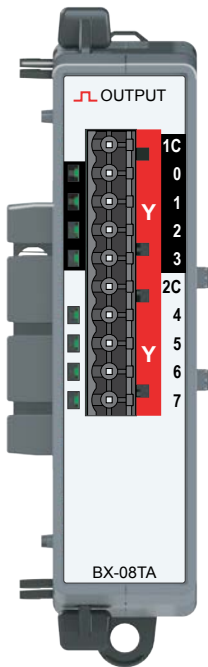

BX-08TA
Output Module
8-pt, 120–240 VAC

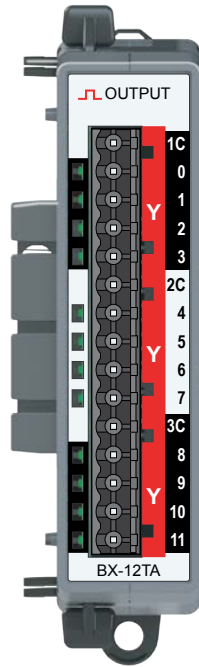

BX-12TA
Output Module
12-pt, 120–240 VAC

Terminal Blocks or
ZIPLink Cables Sold
Separately

We recommend using prewired ZIPLink cables and connection modules. If you wish to hand-wire your module, a removable terminal block is available. See Wiring Termination Selection in this chapter for all options.



IMPORTANT!



Hot-Swapping Information
Note: This device cannot be Hot Swapped.

BX-xxTA 120–240 VAC Output, continued

Discrete Output Specifications		
	BX-08TA	BX-12TA
Output Type	Triac	
Outputs per Module	8	12
Commons	2 (4 points/common) Isolated	3 (4 points/common) Isolated
Maximum Current per Common	2A	
Nominal Voltage Range	120–240 VAC	
Operating Voltage Range	5–258 VAC	
Maximum Voltage	258VAC	
Maximum Output Current	0.5 A across temp range	
Current Derating	Linear by Common: 2A @ 25°C - 1A @ 60°C	
Maximum Inrush Current	5A for 50ms	
Maximum Leakage Current	1µA	
Heat Dissipation	4.8 W Max	7.1 W Max
ON Voltage Drop	2.5 Vmax	
ON-OFF Response	<10ms	
OFF-ON Response	<10ms	
Fuse Type	User-supplied external fuse	
Status Indicators	Logic Side, Green	
Software Version Required	Do-more! Designer version 2.0 or later	

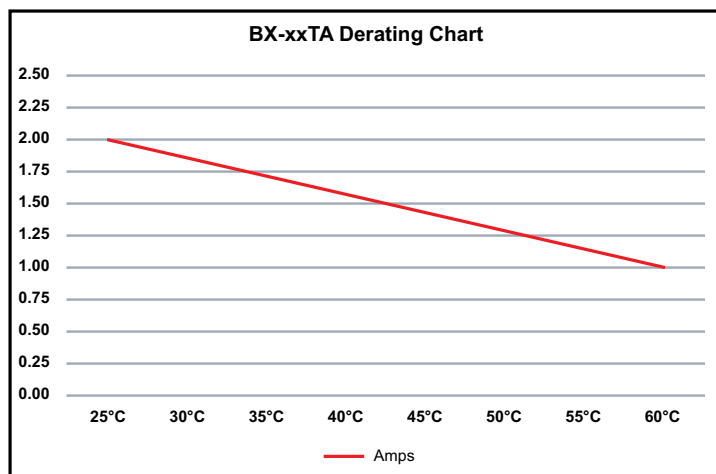

Triac Output Wiring Diagram

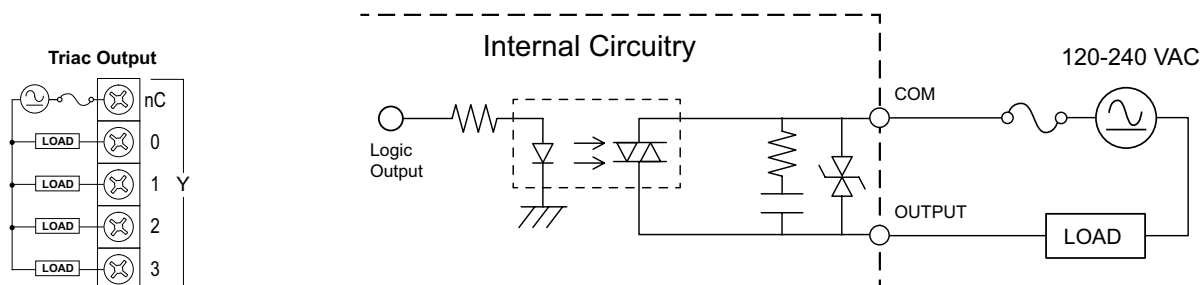

BX-08CD3R Combination DC Input/Relay Output

The BX-08CD3R Combination DC Input/Relay Output Expansion Module provides a total of eight (8) points; four (4) 12–24 VDC sink/source inputs and four (4) Form A (SPST) relay outputs.

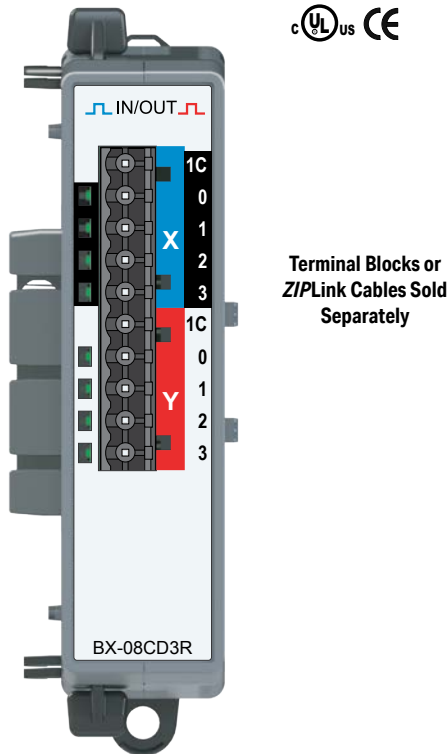

We recommend using prewired Z/PLink cables and connection modules. If you wish to hand-wire your module, a removable terminal block is available. See Wiring Termination Selection in this chapter for all options.



IMPORTANT!



Hot-Swapping Information

Note: This device cannot be Hot Swapped.

Module Specifications

Heat Dissipation	4.1 W Max
Status Indicators	Logic Side, Green
Software Version Required	Do-more! Designer version 2.0 or later

Discrete Input Specifications

Input Type	Sink/Source
Inputs per Module	4
Nominal Voltage Range	12–24 VDC
Input Voltage Range	9–30 VDC
Maximum Voltage	30VDC
Commons	1 (4 points/common)
Input Current (typical)	8mA @ 24VDC
Maximum Input Current	12mA @ 30VDC
Input Impedance	3kΩ @ 24VDC
ON Voltage Level	> 9.0 VDC
OFF Voltage Level	< 2.0 VDC
Minimum ON Current	5.0 mA (9V required-guarantee ON state)
Maximum OFF Current	2.0 mA
OFF-ON Response	2ms
ON-OFF Response	2ms

Discrete Output Specifications

Output Type	Relay, Form A (SPST)
Outputs per Module	4
Commons	1 (4 points/common)
Maximum Current per Common	8A
Nominal Voltage Range	12–48 VDC 24–240 VAC
Operating Voltage Range	5–60 VDC 5–264 VAC
Maximum Voltage	60VDC, 264VAC
Minimum Output Current	0.1 mA @24VDC
Maximum Output Current	2A
Maximum Inrush Current	5A for 50ms
Maximum Leakage Current	1μA
ON Voltage Drop	0.2 Vmax
ON-OFF Response	<10ms
OFF-ON Response	<10ms
Fuse Type	User-supplied external fuse
Maximum Switching Frequency	10Hz
Relay Cycle Life	
Mechanical Endurance	5 Million Operations
Electrical Endurance	120,000 Operations

BX-08CD3R Combination DC Input/Relay Output, continued

Discrete Input Wiring Diagrams

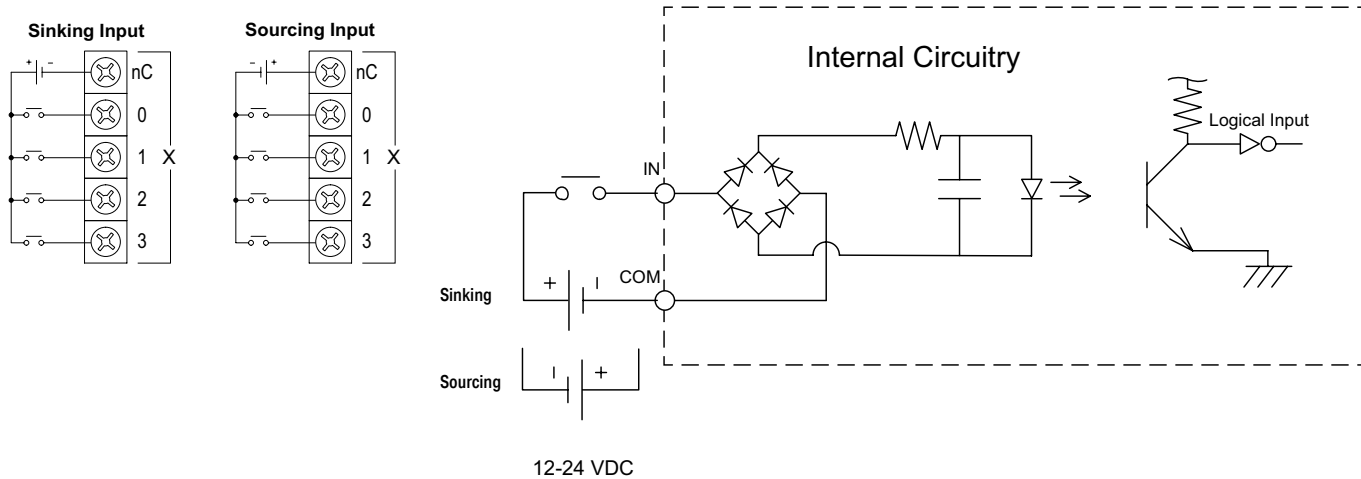

Relay Output Wiring Diagrams

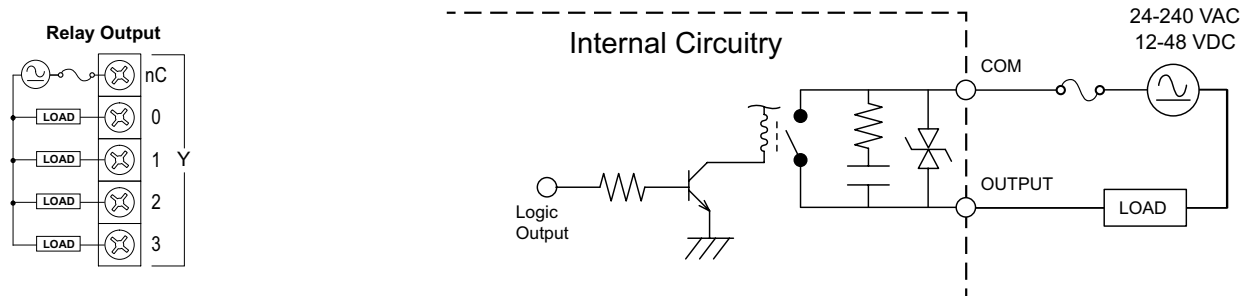

BX-xxCD3D1 Combination DC Input/Sinking DC Output

The BX-xxCD3D1 Combination DC Input/Sourcing Output Expansion Modules provides a total of twelve (12) or sixteen (16) points; eight (8) 12–24 VDC sink/source inputs and either four (4) or eight (8) 12–24 VDC sinking outputs.

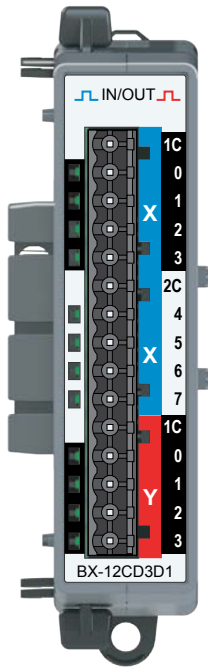

BX-12CD3D1

Combination Discrete Module
 Input: 8-pt, 12–24 VDC, Sink/Source,
 Output: 4-pt, 12–24 VDC, Sinking

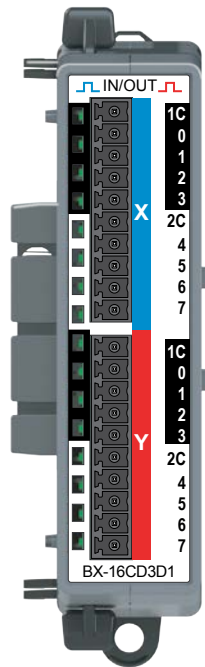

BX-16CD3D1

Combination Discrete Module
 Input: 8-pt, 12–24 VDC, Sink/Source,
 Output: 8-pt, 12–24 VDC, Sinking



Terminal Blocks or
 ZIPLink Cables Sold
 Separately

We recommend using prewired ZIPLink cables and connection modules. If you wish to hand-wire your module, a removable terminal block is available. See Wiring Termination Selection in this chapter for all options.



IMPORTANT!



Hot-Swapping Information

Note: This device cannot be Hot Swapped.

BX-xxCD3D1 Combination DC Input/Sinking DC Output, continued

Module Specifications		
	BX-12CD3D1	BX-16CD3D1
Heat Dissipation	3.5 W Max	3.9 W Max
Status Indicators	Logic Side, Green	
Software Version Required	Do-more! Designer version 2.0 or later	

Discrete Input Specifications		
	BX-12CD3D1	BX-16CD3D1
Input Type	Sink/Source	
Inputs per Module	8	
Commons	2 (4 points/common) Isolated	
Nominal Voltage Range	12–24 VDC	
Input Voltage Range	9–30 VDC	
Maximum Voltage	30VDC	
Input Impedance	3k Ω @ 24VDC	
Input Current (typical)	8mA @ 24VDC	
Maximum Input Current	12mA @ 30VDC	
ON Voltage Level	> 9.0 VDC	
OFF Voltage Level	< 2.0 VDC	
Minimum ON Current	5.0 mA (9V required-guarantee ON state)	
Maximum OFF Current	2.0 mA	
OFF-ON Response	2ms	
ON-OFF Response	2ms	

Discrete Output Specifications		
	BX-12CD3D1	BX-16CD3D1
Output Type	Sinking	
Outputs per Module	4	8
Commons	1 (4 points/common)	2 (4 points/common) Isolated
Maximum Current per Common	2A	
Nominal Voltage Range	12–24 VDC	
Operating Voltage Range	5–36 VDC	
Maximum Voltage	36VDC	
Minimum Output Current	0.1 mA @ 24VDC	
Maximum Output Current	0.5 A per output, no derating over temperature range	
Maximum Inrush Current	5A for 50ms	
Maximum Leakage Current	10 μ A	
ON Voltage Drop	0.05 VDC	
Fuse Type	User-supplied external fuse	
OFF-ON Response	< 5ms	
ON-OFF Response	< 2ms	

BX-xxCD3D1 Combination DC Input/DC Sinking Output, continued

Discrete Input Wiring Diagrams

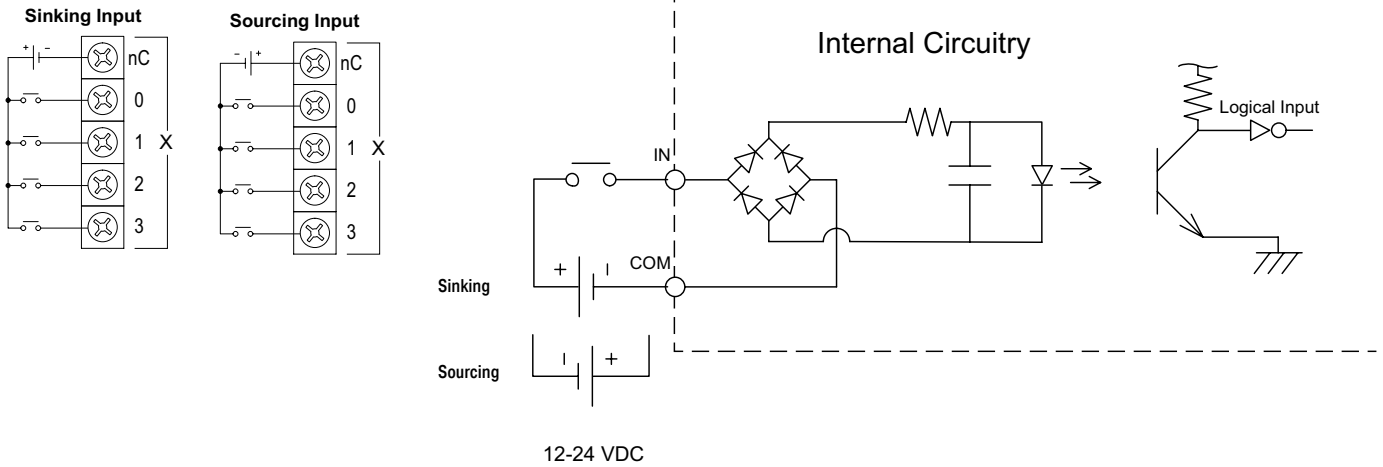

Discrete Output Wiring Diagrams

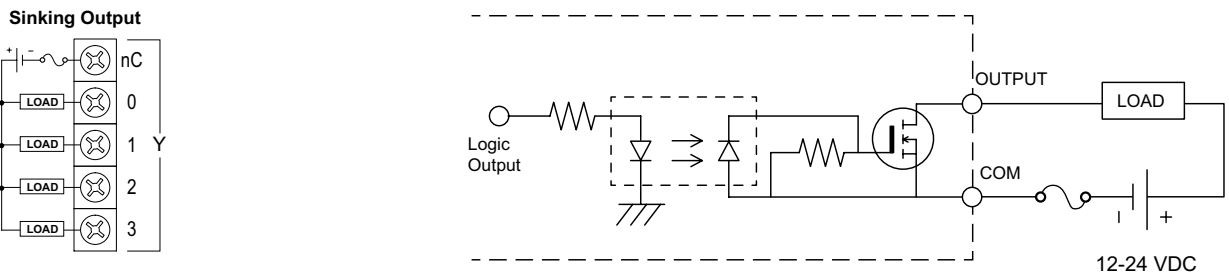

BX-xxCD3D2 Combination DC Input/Sourcing DC Output

The BX-xxCD3D2 Combination Input/Output Expansion Modules provides a total of twelve (12) or sixteen (16) points; eight (8) 12–24 VDC sink/source inputs and either four (4) or eight (8) 12-24 VDC sourcing outputs.

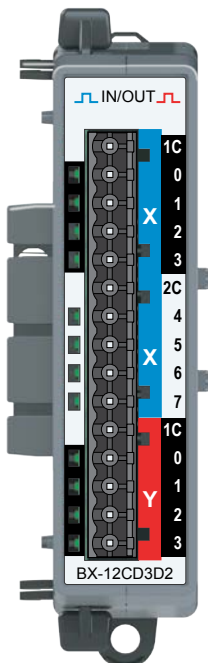

BX-12CD3D2

Combination Discrete Module
 Input: 8-pt, 12–24 VDC, Sink/Source
 Output: 4-pt, 12–24 VDC, Sourcing

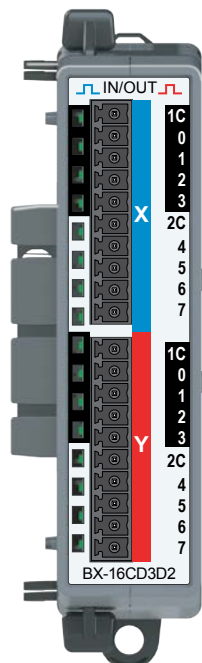

BX-16CD3D2

Combination Discrete Module
 Input: 8-pt, 12–24 VDC, Sink/Source,
 Output: 8-pt, 12–24 VDC, Sourcing



Terminal Blocks or
 ZIPLink Cables Sold
 Separately

We recommend using prewired ZIPLink cables and connection modules.

If you wish to hand-wire your module, a removable terminal block is available. See Wiring Termination Selection in this chapter for all options.



IMPORTANT!



Hot-Swapping Information

Note: This device cannot be Hot Swapped.

BX-xxCD3D2 Combination

DC Input/Sourcing DC Output, continued

Module Specifications		
	BX-12CD3D2	BX-16CD3D2
Heat Dissipation	3.5 W Max	3.9 W Max
Status Indicators	Logic Side, Green	
Software Version Required	Do-more! Designer version 2.0 or later	

Discrete Input Specifications		
	BX-12CD3D2	BX-16CD3D2
Input Type	Sink/Source	
Inputs per Module	8	
Commons	2 (4 points/common) Isolated	
Nominal Voltage Range	12–24 VDC	
Input Voltage Range	9–30 VDC	
Maximum Voltage	30VDC	
Input Impedance	3k Ω @ 24VDC	
Input Current (typical)	8mA @ 24VDC	
Maximum Input Current	12mA @ 30VDC	
ON Voltage Level	> 9.0 VDC	
OFF Voltage Level	< 2.0 VDC	
Minimum ON Current	5.0 mA (9V required-guarantee ON state)	
Maximum OFF Current	2.0 mA	
OFF-ON Response	2ms	
ON-OFF Response	2ms	

Discrete Output Specifications		
	BX-12CD3D2	BX-16CD3D2
Output Type	Sourcing	
Outputs per Module	4	8
Commons	1 (4 points/common)	2 (4 points/common) Isolated
Maximum Current per Common	2A	
Nominal Voltage Range	12–24 VDC	
Operating Voltage Range	5–36 VDC	
Maximum Voltage	36VDC	
Minimum Output Current	0.1 mA @ 24VDC	
Maximum Output Current	0.5 A per output, no derating over temperature range	
Maximum Inrush Current	5A for 50ms	
Maximum Leakage Current	10 μ A	
ON Voltage Drop	0.05 VDC	
Fuse Type	User-supplied external fuse	
OFF-ON Response	< 5ms	
ON-OFF Response	< 2ms	

BX-xxCD3D2 Combination DC Input/DC Sourcing Output, continued

Discrete Input Wiring Diagrams

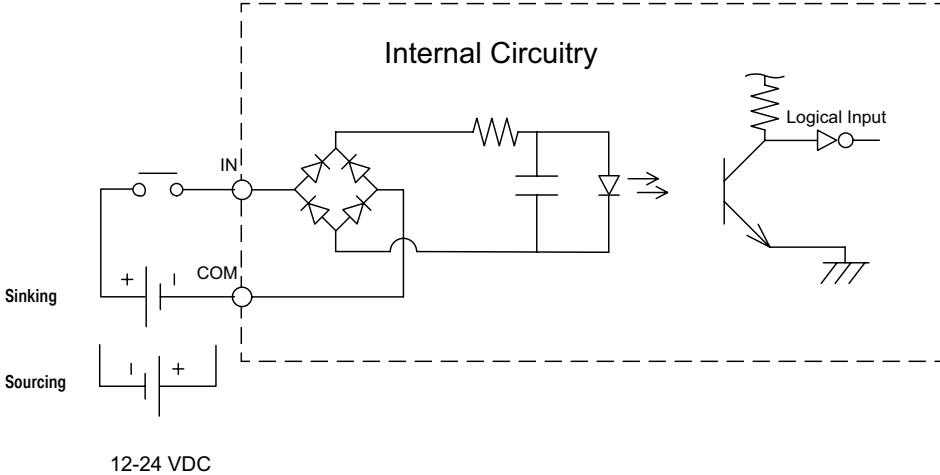
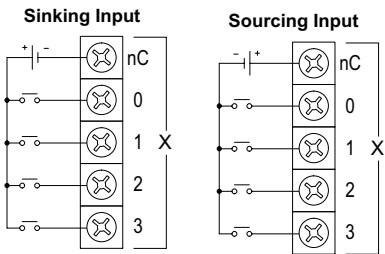

Discrete Output Wiring Diagrams

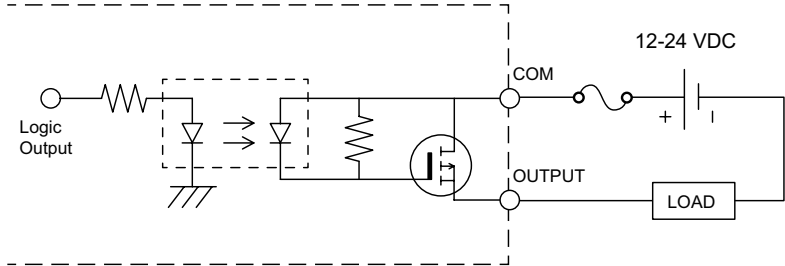
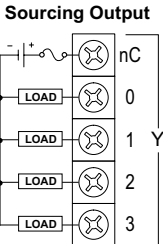

BX-16CF3F2 Combination DC Input/DC Sourcing Output

The BX-16CF3F2 Combination DC Input/DC Sourcing Output Expansion Module provides a total of sixteen (16) points; eight (8) 3–5 VDC sink/source inputs and eight (8) 3–5 VDC sourcing outputs.

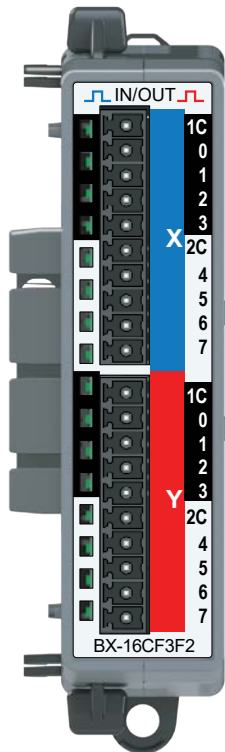

Terminal Blocks or
Z/PLink Cables Sold
Separately

We recommend using prewired Z/PLink cables and connection modules. If you wish to hand-wire your module, a removable terminal block is available. See Wiring Termination Selection in this chapter for all options.



IMPORTANT!



Hot-Swapping Information

Note: This device cannot be Hot Swapped.

Module Specifications

Heat Dissipation	1.5 W Max
Backplane Power Consumption	1.0 W Max
Status Indicators	Logic Side, Green
Software Version Required	Do-more! Designer version 2.8 or later

Discrete Input Specifications

Input Type	Sink/Source
Inputs per Module	8
Nominal Voltage Range	3–5 VDC
Input Voltage Range	2–6 VDC
Maximum Voltage	6VDC
Commons	2 (4 points/common)
Input Impedance	870Ω @ 5VDC
Input Current (typical)	6mA @ 5VDC
Maximum Input Current	8mA @ 6VDC
ON Voltage Level	> 2.0 VDC
OFF Voltage Level	< 0.8 VDC
Minimum ON Current	1.2 mA (2.0 V required to guarantee ON state)
Maximum OFF Current	0.5 mA
OFF-ON Response	2ms
ON-OFF Response	2ms

Discrete Output Specifications

Output Type	Sourcing
Outputs per Module	8
Commons	2 (4 points/common)
Maximum Current per Common	96mA
Power Supply	Internal +5VDC
Peak Voltage	5.5 VDC
Minimum Output Current	0μA
Maximum Output Current	24mA per output, no derating over temperature range
Maximum Leakage Current	10μA
ON Voltage Drop	0.05 VDC
Fuse Type	N/A
OFF-ON Response	< 5ms
ON-OFF Response	< 2ms

BX-16CF3F2 Combination DC Input/DC Sourcing Output, continued

Discrete Input Wiring Diagrams

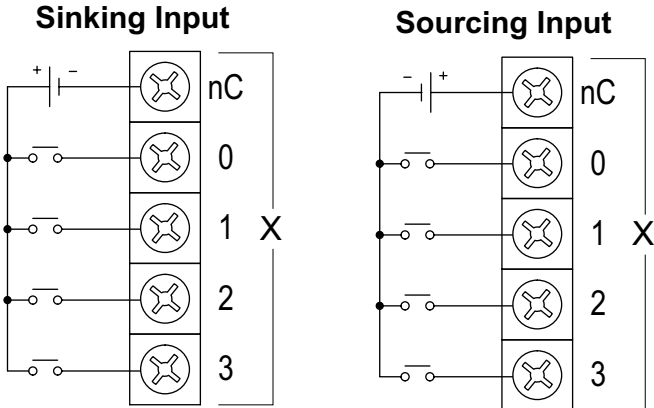

Discrete Output Wiring Diagrams

