

BX-MBIO MODBUS I/O CONTROLLER



In This Chapter...

Overview.....	15-2
BX-MBIO I/O Controllers	15-3
General Specifications	15-3
Serial Port Connector	15-4
Power Supply Connector	15-5
Power Supply Specifications for BX-MBIO-M.....	15-6
Power Supply Connections	15-6
Power Supply Specifications for BX-MBIO-M-D	15-7
Power Supply Connections	15-7
Configuration	15-8
DIP Switch Specifications	15-8
Status Indicators.....	15-9
Modbus Protocol Function Codes Supported by BX-MBIO.....	15-10
Modbus Protocol Exception Responses	15-13
Modbus RTU, Serial Communications.....	15-15
Modbus TCP, Ethernet Communications	15-20
BX-MBIO Configuration.....	15-20
Troubleshooting with Modbus Poll	15-34
Detailed Example: Using the Modbus Poll Utility to Verify Communications With BX-MBIO.....	15-34
Additional BX-EBC100 and BX-MBIO Modbus Mapping Information.....	15-45
Modbus Mapping for I/O	15-45
System Memory Modbus Mapping	15-45
Error Codes	15-47

Overview

The BX-MBIO Modules are remote I/O controller modules that provides a remote I/O drop using the Modbus protocol for communications. They are Modbus RTU slave devices and Modbus TCP servers. They function as listening/replying devices and can connect with any mastering (client) device that communicates using the Modbus protocol.

Modbus RTU is supported over an RS-485 serial connection. Modbus TCP is supported over an Ethernet connection. Any Modbus RTU master and Modbus TCP client that adheres to the Modbus.Org standards, and support the function codes listed in this chapter, can communicate with the BX-MBIO.

The units have no built-in I/O points. The user can customize the I/O to meet the needs of their application by adding as many as eight (8) BRX Expansion Modules, allowing more flexibility while keeping control costs down.

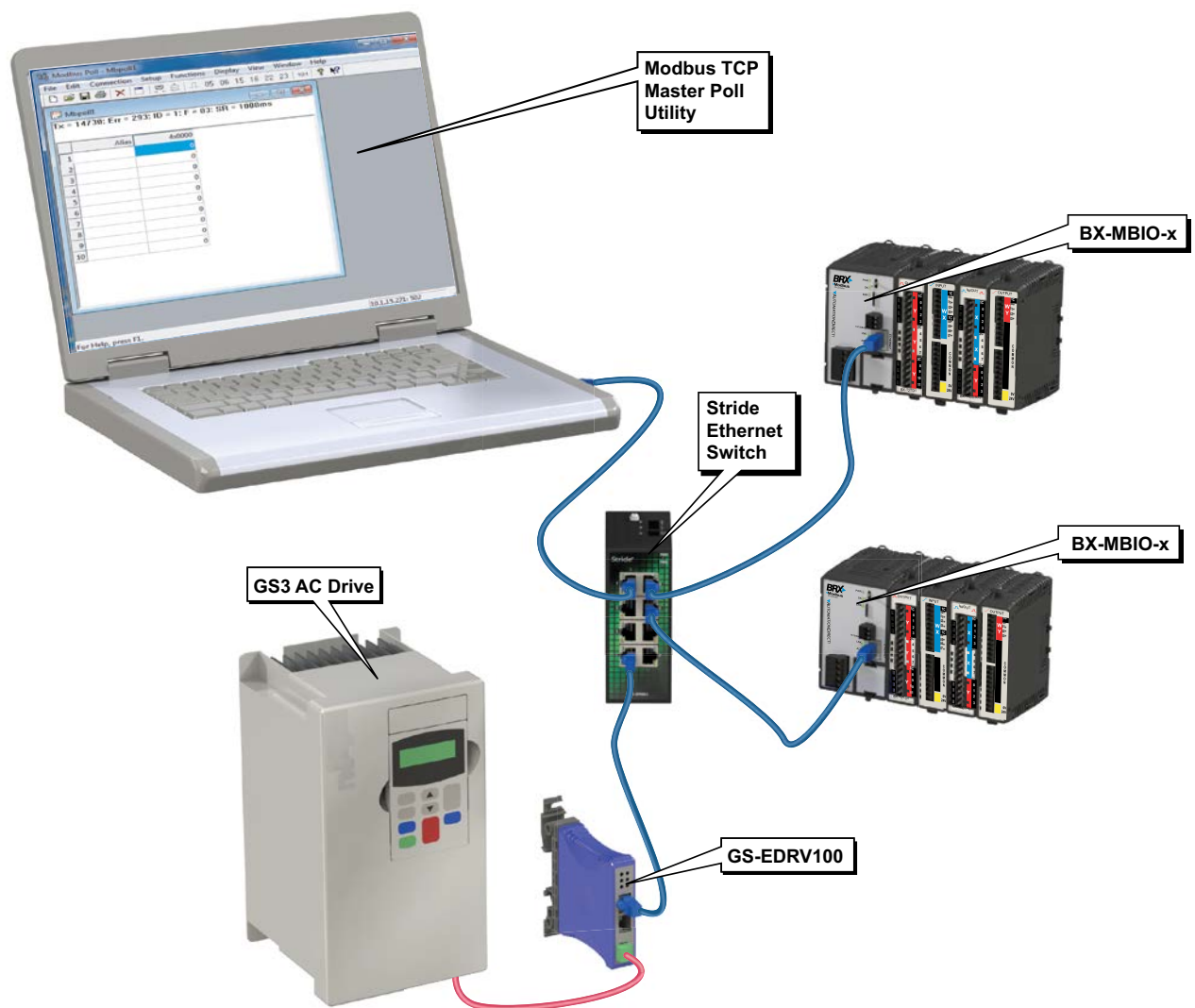

BX-MBIO I/O Controllers

General Specifications

- RJ45 Ethernet port for communications via Modbus TCP
- RS485 serial port for communications via Modbus RTU
- No support for Pluggable Option Module (POM)
- Supports up to 8 additional Expansion Modules
- No built-in discrete or analog I/O
- AC and DC powered units available
- AC powered units include an integral 24VDC auxiliary output power supply
- Power connector and serial port connector included



BX-MBIO-M
Modbus I/O Controller



BX-MBIO-M-D
Modbus I/O Controller

BX-MBIO Controllers			
Part Number	External Power	Expansion Modules	Can be Used With
BX-MBIO-M	120–240 VAC	8	Modbus RTU Modbus TCP
BX-MBIO-M-D	12–24 VDC	8	

General Specifications, continued

General Specifications		
Part Number	BX-MBIO-M	BXC-MBIO-M-D
Operating Temperature	0° to 60°C (32° to 140°F)	
Storage Temperature	-20° to 85°C (-4° to 185°F)	
Humidity	5 to 95% (non-condensing)	
Environmental Air	No corrosive gases permitted	
Vibration	IEC60068-2-6 (Test Fc)	
Shock	IEC60068-2-27 (Test Ea)	
Enclosure Type	Open Equipment	
Agency Approvals	UL61010-2 - UL File # E185989 Canada and USA CE Compliant EN61131-2	
Noise Immunity	NEMA ICS3-304	
EU Directive	See the "EU Directive" topic in the Help File	
Heat Dissipation	10.8 W Max	8.6 W Max
Weight	198g (7oz)	170g (6oz)
Software Version	NetEdit Version 3.15 or later	



NOTE: Eight (8) Expansion Modules can be connected to add I/O capability. Only Discrete and Analog Expansion Modules are supported.



NOTE: If you are a Do-more! user and are looking to add additional remote I/O you should consider the BX-DMIO or the BX-EBC100 for a lower cost and easier installation and startup. (See Chapter 14 for more detail.) The BX-MBIO Controllers are designed for systems that use Modbus Clients as remote I/O drops.

Serial Port Connector

BX-MBIO Serial Port Connector Specifications	
Part Number	BX-RTB03S
Connector Type	Screw Type-90° (included with unit)
Wire Exit	180 deg
Pitch	3.5 mm
Screw Size	M2
Recommended Screw Torque	< 1.77 lb-in (0.2 N·m)
Screwdriver Blade Width	2.5 mm
Wire Gauge (Single wire)	28-16 AWG
Wire Gauge (Two wires)	28-16 AWG
Wire Strip Length	0.24 in (6mm)
Equiv. Dinkle P/N	EC350V-03P-BK



BX-RTB03S

Power Supply Connector

The power supply terminal block connector is included with each controller. The power supply connector is a screw type, removable terminal block. Replacement connectors and specifications are listed in the tables that follow.

BX-MBIO-M AC Power Supply Connector Specifications			
Part Number	BX-RTB05 (Included w/Unit)	BX-RTB05-1	BX-RTB05-2
Connector Type	Screw Type-90 deg	Spring Clamp Type-180 deg	Screw Type-180 deg
Wire Exit	180 deg	180 deg	180 deg
Pitch	5.0 mm	5.0 mm	5.0 mm
Screw Size	M2.5	N/A	M2.5
Recommended Screw Torque	< 3.98 lb·in (0.45 N·m)	N/A	< 3.98 lb·in (0.45 N·m)
Screwdriver Blade Width	3.5 mm	3.5 mm	3.5 mm
Wire Gauge (Single wire)	28–12 AWG	28–14 AWG	28–14 AWG
Wire Gauge (Two wire)	28–16 AWG	28–16 AWG (Dual Wire Ferrule Required)	28–16 AWG (Dual Wire Ferrule Required)
Wire Strip Length	0.3 in (7.5 mm)	0.37 in (9.5 mm)	0.37 in (9.5 mm)
Equiv. Dinkle P/N	5ESDV-05P-BK	5ESDSR-05P-BK	5ESDF-05P-BK



BX-RTB05



BX-RTB05-1



BX-RTB05-2

BX-MBIO-M-D DC Power Supply Connector Specifications			
Part Number	BX-RTB03 (Included w/Unit)	BX-RTB03-1	BX-RTB03-2
Connector Type	Screw Type-90 deg	Spring Clamp Type-180 deg	Screw Type-180 deg
Wire Exit	180 deg	180 deg	180 deg
Pitch	5.0 mm	5.0 mm	5.0 mm
Screw Size	M2.5	N/A	M2.5
Recommended Screw Torque	< 3.98 lb·in (0.45 N·m)	N/A	< 3.98 lb·in (0.45 N·m)
Screwdriver Blade Width	3.5 mm	3.5 mm	3.5 mm
Wire Gauge (Single wire)	28–12 AWG	28–14 AWG	28–12 AWG
Wire Gauge (Two wires)	28–16 AWG	28–16 AWG (Dual Wire Ferrule Required)	28–16 AWG
Wire Strip Length	0.3 in (7.5 mm)	0.37 in (9.5 mm)	0.3 in (7.5 mm)
Equiv. Dinkle P/N	5ESDV-03P-BK	5ESDSR-03P-BK	5ESDF-03P



BX-RTB03



BX-RTB03-1



BX-RTB03-2

Power Supply Specifications for BX-MBIO-M

BX-MBIO-M Power Supply Specifications	
Nominal Voltage Range	120–240 VAC
Input Voltage Range (Tolerance)	85–264 VAC
Rated Operating Frequency	47–63 Hz
Maximum Input Power	40VA
Cold Start Inrush Current	1.5 A, 2ms
Maximum Inrush Current (Hot Start)	1.5 A, 2ms
Internal Input Fuse Protection	Micro fuse 250V, 2A Non-replaceable
Acceptable External Power Drop Time	10ms
Under Input Voltage Lock-out	80VAC
Input Transient Protection	Input choke and line filter
Output Protection for Over Current, Over Voltage, and Over Temperature	Self resetting
Auxiliary 24VDC Output	24VDC @ 0.3 A max, <1V P-P Ripple, Integrated self-resetting short circuit protection, Isolated
Voltage Withstand (dielectric)	1500VAC Power Inputs to Ground applied for 1 minute 1500VAC Ground to 24VDC Output applied for 1 minute
Insulation Resistance	>10M Ω @ 500VDC

Power Supply Connections

Pin	Connection
1	L
2	N
3	GND
4	V-
5	V+



Removable Connector Included
ADC Part # BX-RTB05

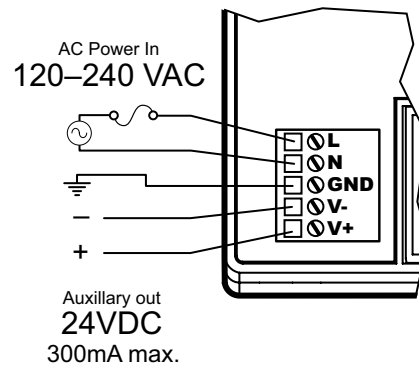

WARNING: Do not exceed the 24VDC auxiliary power supply load limit of 300mA.



WARNING: The BRX System **MUST** have a proper earth ground. Do not operate the BRX MPU without proper earth grounding.

Power Supply Specifications for BX-MBIO-M-D

BX-MBIO-M-D Power Supply Specifications	
Nominal Voltage Range*	12–24 VDC
Input Voltage Range (Tolerance)*	10–36 VDC
Maximum Input Voltage Ripple	< ±10%
Maximum Input Power	30W
Cold Start Inrush Current	5A, 2ms
Maximum Inrush Current (Hot Start)	5A, 2ms
Internal Input Protection	Reverse polarity protection and undervoltage lockout via transistor circuit
Acceptable External Power Drop Time	10ms
Under Input Voltage Lock-out	<9VDC
Output Protection for Over Current, Over Voltage, and Over Temperature	Self resetting
Auxiliary 24VDC Output	None
Voltage Withstand (dielectric)	1500VAC power Inputs to ground applied for 1 minute
Insulation Resistance	>10MΩ @ 500VDC

* Class 2 or LPS Power Supply required.

Power Supply Connections

Pin	Connection
1	GND
2	PWR –
3	PWR +



Removable Connector Included
ADC Part # BX-RTB03

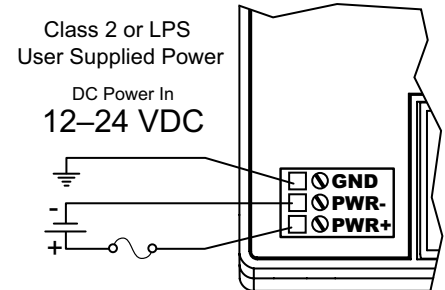

WARNING: The BRX System **MUST** have a proper earth ground. Do not operate the BRX MPU without proper earth grounding.

Configuration

The BX-MBIO controller can be configured as a serial Modbus RTU slave or as a Ethernet Modbus TCP server.

As a Modbus RTU serial slave you can simply use the dip switches and set the module ID. Using the default settings no other setup is needed. Any changes to the configuration of the controller is done through the Ethernet port using the NetEdit 3 utility to get access to the web configuration page of the controller. See Appendix E if needed on how to use the NetEdit 3 utility to gain this access.

Default settings:

- The serial port - 115,200 baud, 8 data bits, parity None, 1 stop bit
- The attached expansion modules - see the expansion module specifications for the default settings for each module.

As a Modbus TCP Ethernet server the NetEdit 3 utility will be needed to set the Ethernet settings and to gain access to the web configuration page. See appendix E if needed on how to use the NetEdit 3 Utility to gain this access.

DIP Switch Specifications

The BX-MBIO Modbus I/O controller has a block of DIP switches, located on the top of the chassis, that are used to setup the serial port station number, write protect the module and disable the Web configuration page. The DIP switch settings are read when the system is powered up. The default position for all DIP switches is OFF.



WARNING: The BX-MBIO Modbus I/O controller must be powered down prior to changing DIP switch settings.

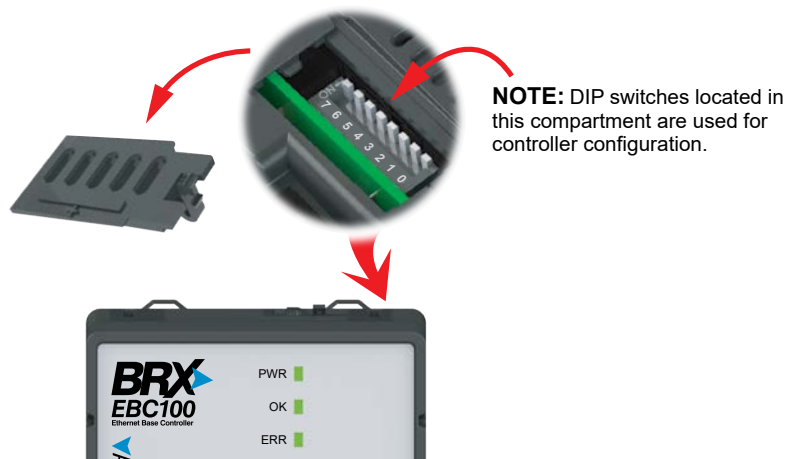

The following table describes the position and function associated with each DIP switch.

DIP Switch Settings		
DIP#	Switch Position	Function
7	ON	Reserved
6	ON	Reset the module to factory default
5	ON	Write protect the module. No writes to flash memory are allowed. Disable Web configuration page.
4	ON	Station number: DIP Switch 0–4: Supports addresses 1 to 31. All DIP Switch OFF: Station number from flash. Enter via Nedit 3 or Web configuration page. Supports addresses 1 to 247.
3	ON	
2	ON	
1	ON	
0	ON	



DIP Switch position is read when power is applied to the module. Power down the module before changing DIP switch settings.

DIP switches 0 to 4: Use to set a fixed serial port station number, from 1 to 31. If all five switches are left in the OFF position, the station number will be read from the module flash. The user can use the utility NetEdit 3 or, if enabled, the user can use the Web configuration page to set the RS-485 station number, from 1 to 247.

DIP Switch 5: When ON, it will write protect the module. It will not be possible to update the network settings, update the firmware or the booter version. It also disables access to the Web configuration page.

DIP Switch 6: When ON, the module is reset to factory defaults.

Status Indicators

BX-MBIO Status Indicators		
Indicator	Status	Description
PWR	OFF	Base Power is OFF
	GREEN	Base Power is Good
OK	GREEN	Controller is Functioning Normally
	GREEN (Blinking)	Reset Mode (Booter without OS)
	YELLOW	Analog Module Mismatch
	OFF	Controller HW Error or Power is OFF
ERR	OFF	Controller is Functioning Normally
	RED	Controller HW Error or Communications Watchdog Timeout
	RED (Blinking)	Reset Mode (Booter without OS)
TX	OFF	No Transmit Activity
	GREEN (Blinking)	Data is being Transmitted
RX	OFF	No Receive Activity
	GREEN (Blinking)	Data is being Received
LNK	OFF	No Ethernet Link
	GREEN	Ethernet Link is Good
ACT	OFF	No Ethernet Activity
	GREEN (Blinking)	Ethernet Activity

Modbus Protocol Function Codes Supported by BX-MBIO

Modbus Protocol Function Codes		
Function Type	Modbus Function Code	
	(Decimal)	(Hex)
Read Coil Status	01	01
Read Input Status	02	02
Read Holding Registers	03	03
Read Input Registers	04	04
Force Single Coil	05	05
Preset Single Register	06	06
Force Multiple Coils	15	0F
Force Multiple Registers	16	10
Mask Write Register	22	16



NOTE: Please visit Modbus.org to get information on the latest revision of the Modbus Protocol Specifications.

Function 01 (0x01) Read Coils

This function code is used to read the status of a block (1 to 2000) of contiguous coils (bits) in a remote device. Depending on the type of Modbus slave, coils can be used as internal bits or physical discrete outputs.

Modbus data type identifier: 0xxxxx

Modbus address range: 000001 to 065536

Example: Coil 17 is referred to as 000017

Function 02 (0x02) Read Discrete Inputs

This function code is used to read the status of a block (1 to 2000) of contiguous discrete inputs (bits) in a remote device.

Modbus data type identifier: 1xxxxx

Modbus address range: 100001 to 165536

Example: Discrete input 31 is referred to as 1000031

Function 03 (0x03) Read Holding Registers

This function code is used to read the contents of a block (1 to 125) of contiguous holding registers in a remote device. Holding registers are 16 bit words. Depending on the Modbus slave, Holding Registers may be used to address Analog Outputs or used as general purpose registers to store values in the program.

Modbus data type identifier: 4xxxxx

Modbus address range: 400001 to 465536

Example: Holding Register 2035 is referred to as 402035

Modbus Protocol Function Codes Supported by BX-MBIO, continued

Function 04 (0x04) Read Input Registers

This function code is used to read the contents of a block (1 to 125) of contiguous input registers in a remote device. Input Registers are 16 bit words. Depending on the Modbus slave, they may be used to address Analog Inputs or read-only values.

Modbus data type identifier: 3xxxxx

Modbus address range: 300001 to 365536

Example: Input Register 1027 is referred to as 301027

Function 05 (0x05) Write Single Coil

This function code is used to write a single output to either ON or OFF in a remote device. Depending on the type of Modbus slave, coils can be used as internal bits or physical discrete outputs.

Modbus data type identifier: 0xxxxx

Modbus address range: 000001 to 065536

Example: Coil 17 is referred to as 000017

Function 06 (0x06) Write Single Register

This function code is used to write a single holding register in a remote device. Holding registers are 16-bit words. Depending on the Modbus slave, Holding Registers may be used to address Analog Outputs or used as general purpose registers to store values in the program.

Modbus data type identifier: 4xxxxx

Modbus address range: 400001 to 465536

Example: Holding Register 2035 is referred to as 402035

Function 15 (0x0F) Write Multiple Coils

This function code is used to force each coil in a sequence (1 to 1968) of coils (bits) to either ON or OFF in a remote device. Depending on the type of Modbus slave, coils can be used as internal bits or physical discrete outputs.

Modbus data type identifier: 0xxxxx

Modbus address range: 000001 to 065536

Example: Coil 64 is referred to as 000064

Function 16 (0x10) Write Multiple Registers

This function code is used to write a block (1 to 123 registers) of contiguous Holding Registers in a remote device. Holding registers are 16 bit words. Depending on the Modbus slave, Holding

Registers may be used to address Analog Outputs or used as general purpose registers to store values in the program.

Modbus Protocol Function Codes Supported by BX-MBIO, continued

Modbus data type identifier: 4xxxxx

Modbus address range: 400001 to 465536

Example: Holding Register 2035 is referred to as 402035

Function 22 (0x16) Mask Write Register

This function code is used to modify the contents of a specified holding register using a combination of an AND mask, an OR mask, and the register's current contents. The function can be used to set or clear individual bits in the register.

The request specifies the holding register to be written, the data to be used as the AND mask, and the data to be used as the OR mask.

The function's algorithm is:

Result = (Current Contents AND And_Mask) OR (Or_Mask AND (NOT And_Mask))

For example:

Mask Write Register Example		
	Hex	Binary
Current Contents	12	0001 0010
And_Mask =	F2	1111 0010
Or_Mask =	0D	0000 1101
(NOT And_Mask) =	17	0001 0111
Result =	17	0001 0111

Note:

- If the Or_Mask value is zero, the result is simply the logical ANDing of the current contents and And_Mask. If the And_Mask value is zero, the result is equal to the Or_Mask value.
- The contents of the register can be read with the Read Holding Registers function (function code 03). They could, however, be changed subsequently as the controller scans its user logic program.

Modbus data type identifier: 4xxxxx

Modbus address range: 400001 to 465536

Example: Holding Register 2035 is referred to as 402035

Modbus Protocol Exception Responses

Except for a broadcast message, when a client (master) device sends a request to a server (slave) device it expects a normal response. One of four possible events can occur from the client's (master) query:

- If the server (slave) device receives the query without a communication error, and can handle the query normally, it returns a normal response.
- If the server (slave) does not receive the query due to a communication error, no response is returned. The client (master) will eventually process a timeout condition for the request. (Timeout is fixed at 800ms. Once the first character arrives, the controller waits 800ms for the entire request to arrive.)
- If the server (slave) receives the query, but detects a communication error (parity, LRC, CRC, ...), no response is returned. The client (master) will eventually process a timeout condition for the request. (Timeout is fixed at 800ms. Once the first character arrives, the controller waits 800ms for the entire request to arrive.)
- If the server receives the query without a communication error, but cannot handle it (for example, if the request is to read a non-existent coil or register), the server (slave) will return an Exception Response informing the client (master) of the nature of the error. This Exception Response value from the server (slave) can optionally be stored in a memory location. The BX-MBIO uses a 1-byte Exception Code on an exception response.

Modbus Protocol Exception Responses, continued

List of Modbus Exception Response Codes		
Code	Name	Meaning
01	Illegal Function	The function code received in the query is not an allowable action for the server (or slave). This may be because the function code is only applicable to newer devices, and was not implemented in the unit selected. It could also indicate that the server (or slave) is in the wrong state to process a request of this type, for example because it is unconfigured and is being asked to return register values.
02	Illegal Data Address	The function code received in the query is not an allowable action for the server (or slave). This may be because the function code is only applicable to newer devices, and was not implemented in the unit selected. It could also indicate that the server (or slave) is in the wrong state to process a request of this type, for example because it is unconfigured and is being asked to return register values.
03	Illegal Data Value	A value contained in the query data field is not an allowable value for server (or slave). This indicates a fault in the structure of the remainder of a complex request, such as that the implied length is incorrect. It specifically does NOT mean that a data item submitted for storage in a register has a value outside the expectation of the application program, since the Modbus protocol is unaware of the significance of any particular value of any particular register.
04	Slave Device Failure	An unrecoverable error occurred while the server (or slave) was attempting to perform the requested action.
05	Acknowledge	Specialized use in conjunction with programming commands. The server (or slave) has accepted the request and is processing it, but a long duration of time will be required to do so. This response is returned to prevent a timeout error from occurring in the client (or master). The client (or master) can next issue a Poll Program Complete message to determine if processing is completed.
06	Slave Device Busy	Specialized use in conjunction with programming commands. The server (or slave) is engaged in processing a long duration program command. The client (or master) should retransmit the message later when the server (or slave) is free.
08	Memory Parity Error	Specialized use in conjunction with function codes 20 and 21 and reference type 6, to indicate that the extended file area failed to pass a consistency check. The server (or slave) attempted to read record file, but detected a parity error in the memory. The client (or master) can retry the request, but service may be required on the server (or slave) device.
0A	Gateway Path Unavailable	Specialized use in conjunction with gateways, indicates that the gateway was unable to allocate an internal communication path from the input port to the output port for processing the request. Usually means that the gateway is misconfigured or overloaded.
0B	Gateway Target Device Failed to Respond	Specialized use in conjunction with gateways, indicates that no response was obtained from the target device. Usually means that the device is not present on the network.

Modbus RTU, Serial Communications



RS-485 is a multi-point wiring standard that can be used to connect external devices to the PLC. The RS-485 port has a removable three-pin screw terminal block located on the front of the CPU. The serial port has a software-selectable 120Ω termination resistor available if needed.

RS-485 Specifications	
Port Type	RS-485
Description	Non-isolated serial port that can communicate via RS-485. Includes ESD protection and built-in surge protection. 120Ω Termination resistor is available (software selectable). Includes internal biasing to be a true failsafe receiver while maintaining EIA/TIA-485 compatibility.
Supported Protocols	Modbus RTU (Slave)
Data Rates	1200, 2400, 4800, 9600, 19200, 38400, 57600, and 115200
Timeout	Fixed at 800ms. Once the first character arrives, the controller waits 800ms for the entire request to arrive.
Default Settings	RS-485, 115200 bps, No Parity, 8 Data Bits, 1 Stop Bit, Station #1
Port Type	3-pin terminal strip 3.5mm pitch
RS-485 Station Addresses	1-247
Cable Requirements	RS-485 use L19954-XXX from AutomationDirect.com
Replacement Connector	ADC Part # BX-RTB03S

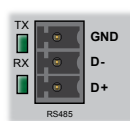

Pinout	RS-485
1	GND
2	D-
3	D+

Removable connector included (ADC Part# BX-RTB03S)

The RS-485 standard supports distances of up to 1000 meters without requiring a repeater. The distance can be increased by placing an RS-485 repeater on the network, if necessary.

RS-485 utilizes a differential signal which makes it much more immune to noise and grounding issues than RS-232 and is therefore a much better choice when available for communications. This port only supports RS-485, 2-wire connections. Please note that there are no connections for RTS (Ready To Send), CTS (Clear To Send) or for port powered devices (+5VDC).

Modbus RTU, Serial Communications, continued

Field Wiring information:

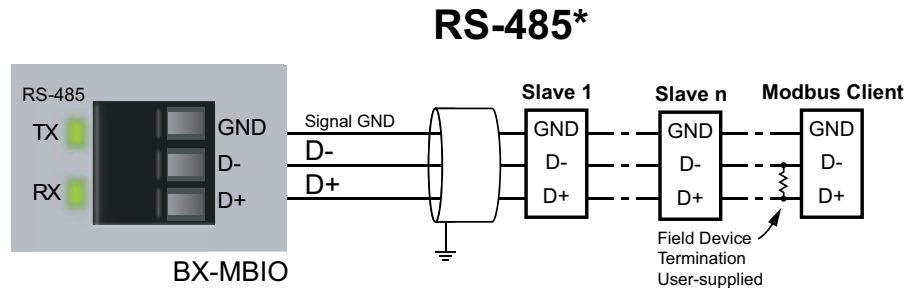

***NOTE:** Termination resistor is built-in and software selectable.
 ADC # L19954-xxx or equivalent is recommend for RS-485 networks.

RS-485 example wiring diagrams

Example Wiring BX-MBIO to PC via RS-485, using Modbus Poll Software as Modbus RTU Master

RS-485 Modbus RTU Network

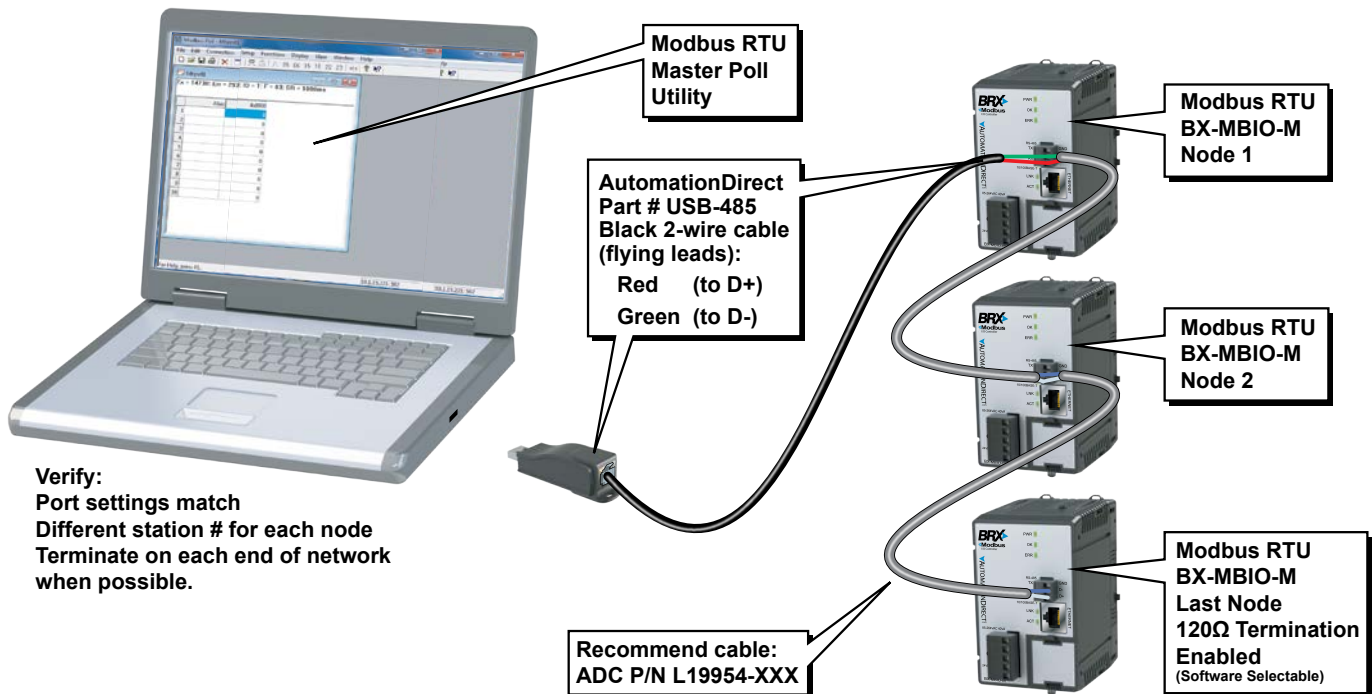

Modbus RTU, Serial Communications, continued

Example Wiring BX-MBIO to C-more HMI via RS-485

RS-485 *C-more* RTU Network

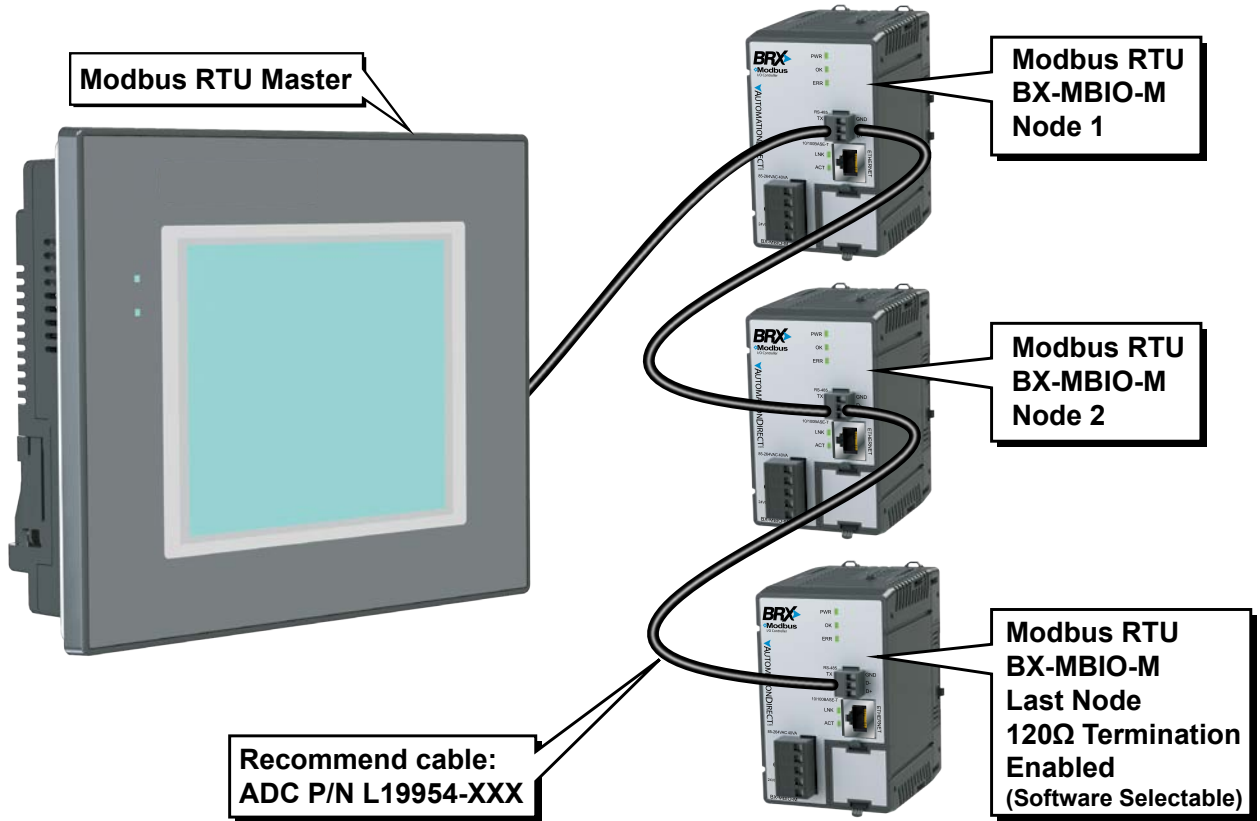

EA-COMCON-3 (-3A)
Terminal Block Adapter
plugs into *C-more* 15-pin
PLC Serial Comm. Port

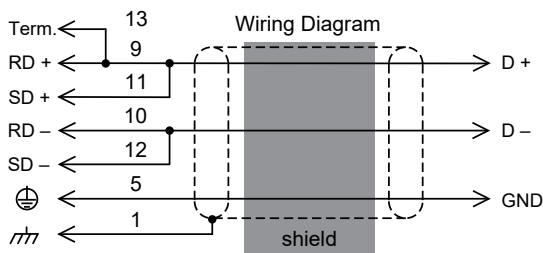
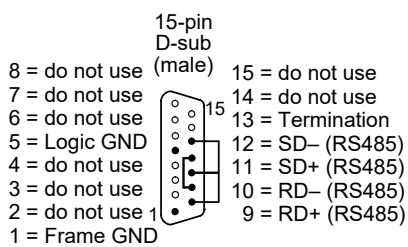
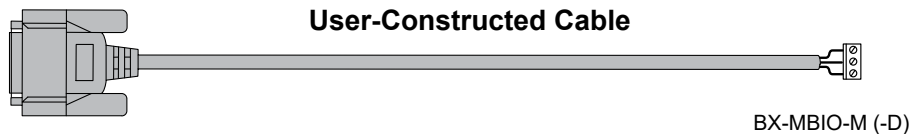
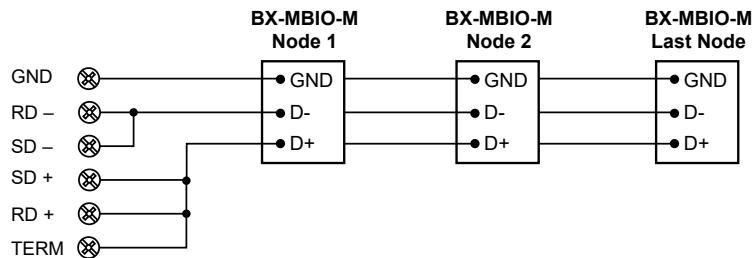
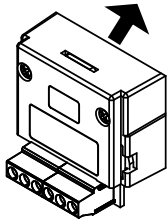

Modbus RTU, Serial Communications, continued

Example Wiring BX-MBIO to Click PLC via RS-485

RS-485 Click to BX-MBIO

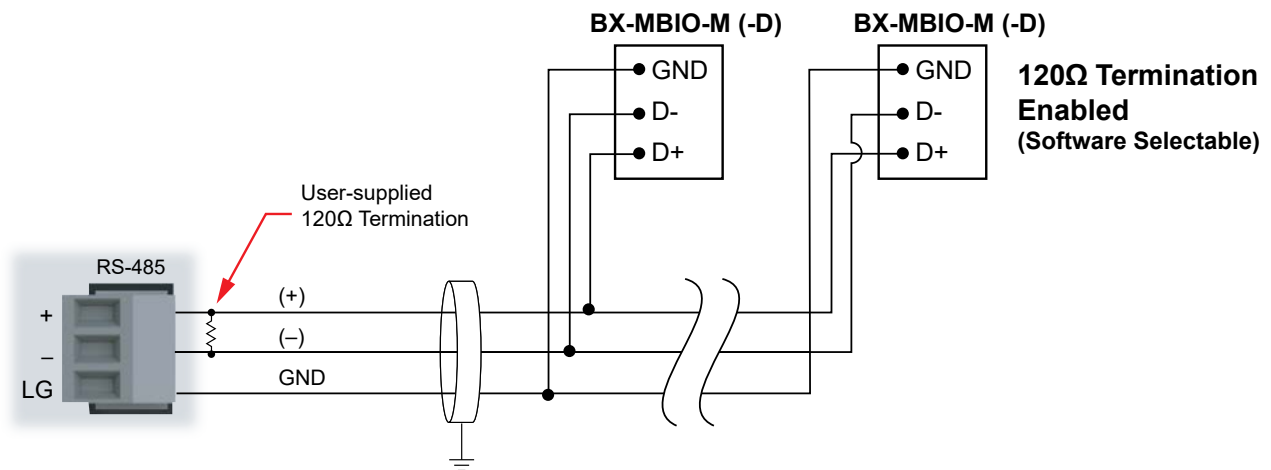
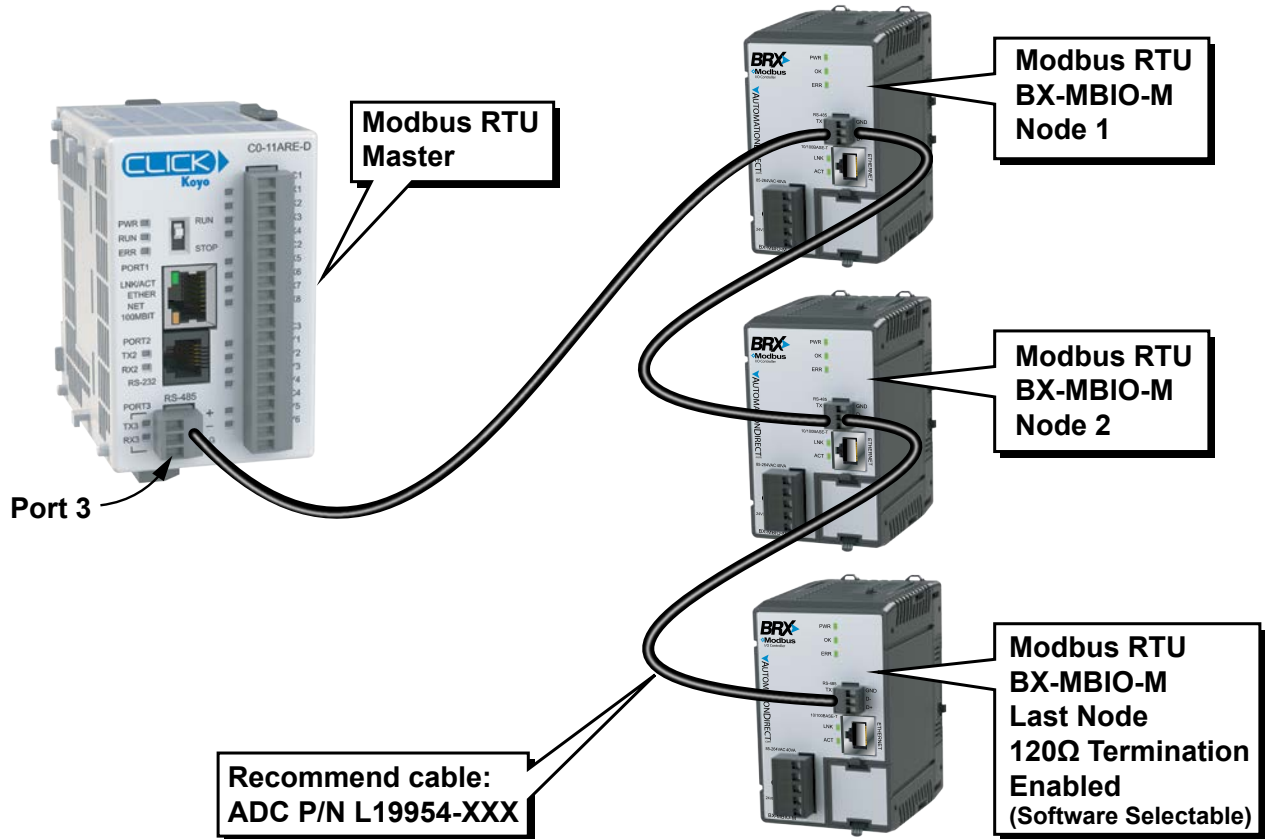

Modbus RTU, Serial Communications, continued

Example Wiring BX-MBIO to Productivity PLC via RS-485

RS-485 Productivity to BX-MBIO

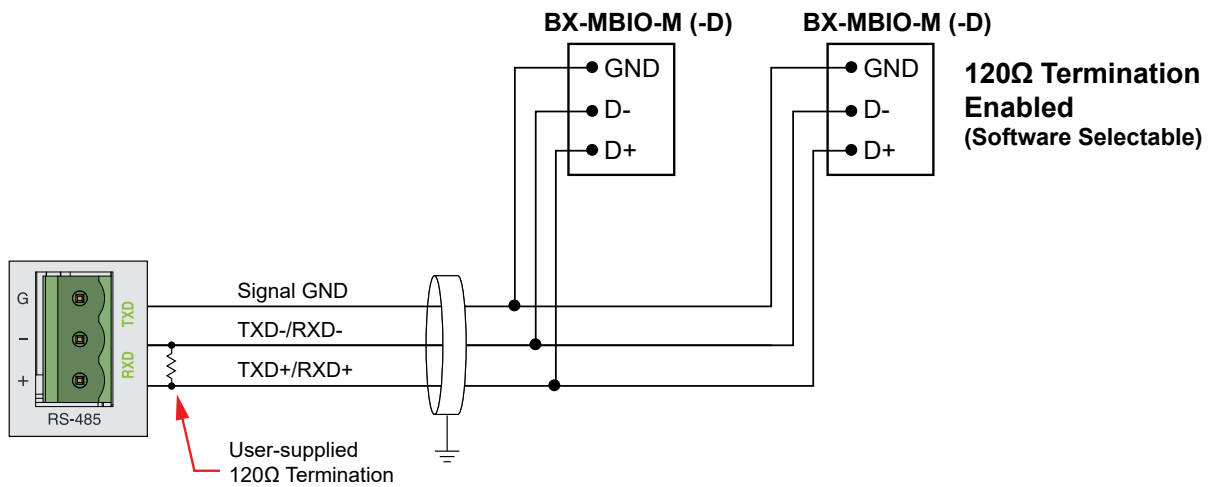
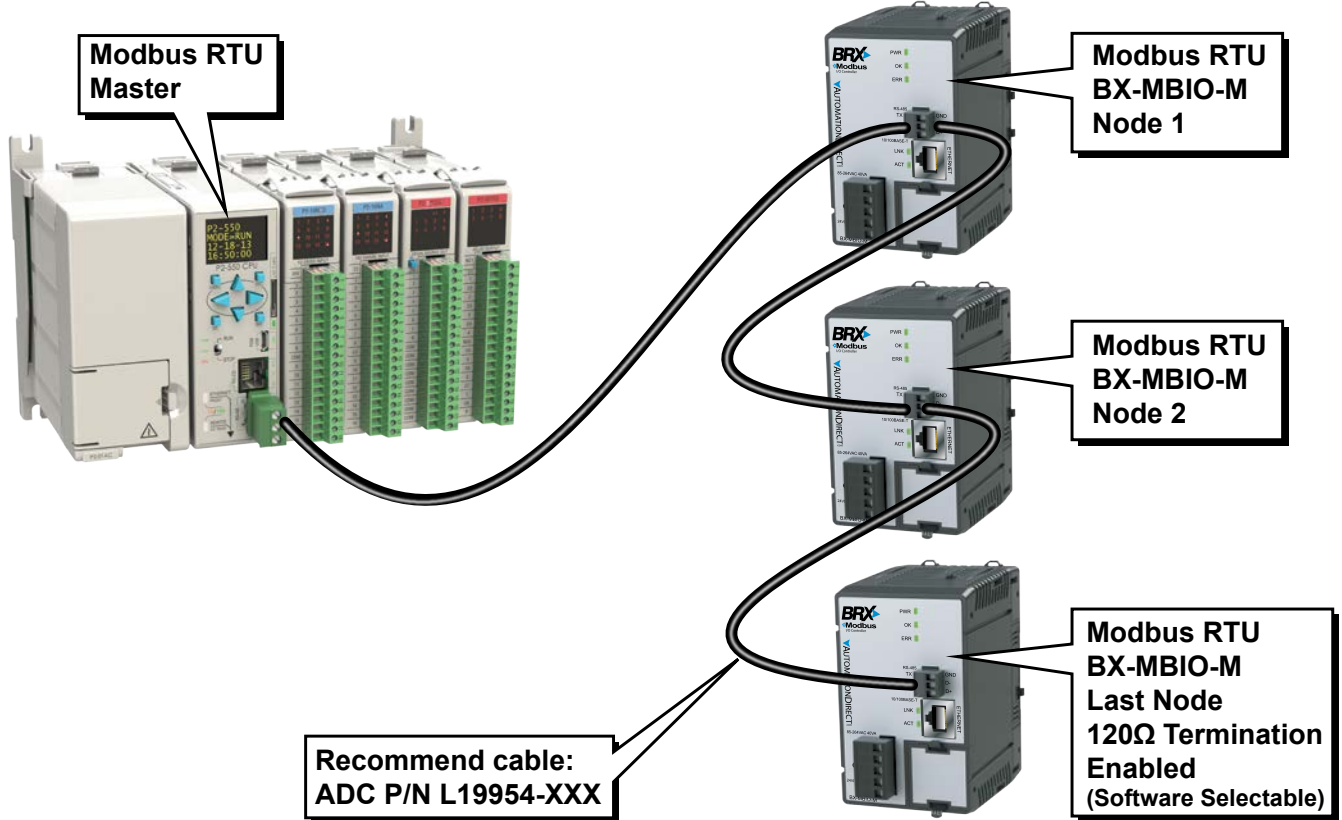

Modbus TCP, Ethernet Communications

The RJ-45 Ethernet port connector is located on the CPU faceplate. Rated at 10/100 Mbps, it accepts standard CAT5e cable and has built-in auto-crossover capability.

Ethernet Specifications	
Port Type	Ethernet
Description	Standard transformer-isolated Ethernet port with built-in surge protection.
Transfer Rate	10Mbps and 100Mbps
Port Status LED	LINK LED is solid when network LINK is established. ACT LED flashes when port is active.
Timeout	Fixed at 800ms. Once the first character arrives, the controller waits 800ms for the entire request to arrive.
Supported Protocols	Modbus TCP (Server)
Cable Recommendation	C5E-STxxx-xx from AutomationDirect.com
Port Type	RJ45, Category 5, 10/100 BASE-T, Auto Crossover
Ethernet Port Numbers: Modbus TCP (Server)	502, TCP

BX-MBIO Configuration

To perform the initial configuration of the BX-MBIO, use the NetEdit 3 utility. Please refer to Appendix E of this manual for information on how the free NetEdit 3 utility is used to manage all aspects of HOST Ethernet-enabled devices. This includes the configuration of the network settings, updating the firmware in the devices, and setting up any runtime configuration options that are available to the HOST device.

Once the BX-MBIO has been assigned an IP address and subnet by using NetEdit 3, it is possible to use the Web Configuration Page to perform additional configurations.

The Web Configuration Page can be accessed via NetEdit 3 or via a browser.

BX-MBIO Configuration, continued

If using NetEdit 3, select BX-MBIO from the list of available HOST Ethernet devices. You can select the “Start Web based Config” from the (1) MBIO Settings tab or from the (2) drop down list you get when you right click on the BX-MBIO row.

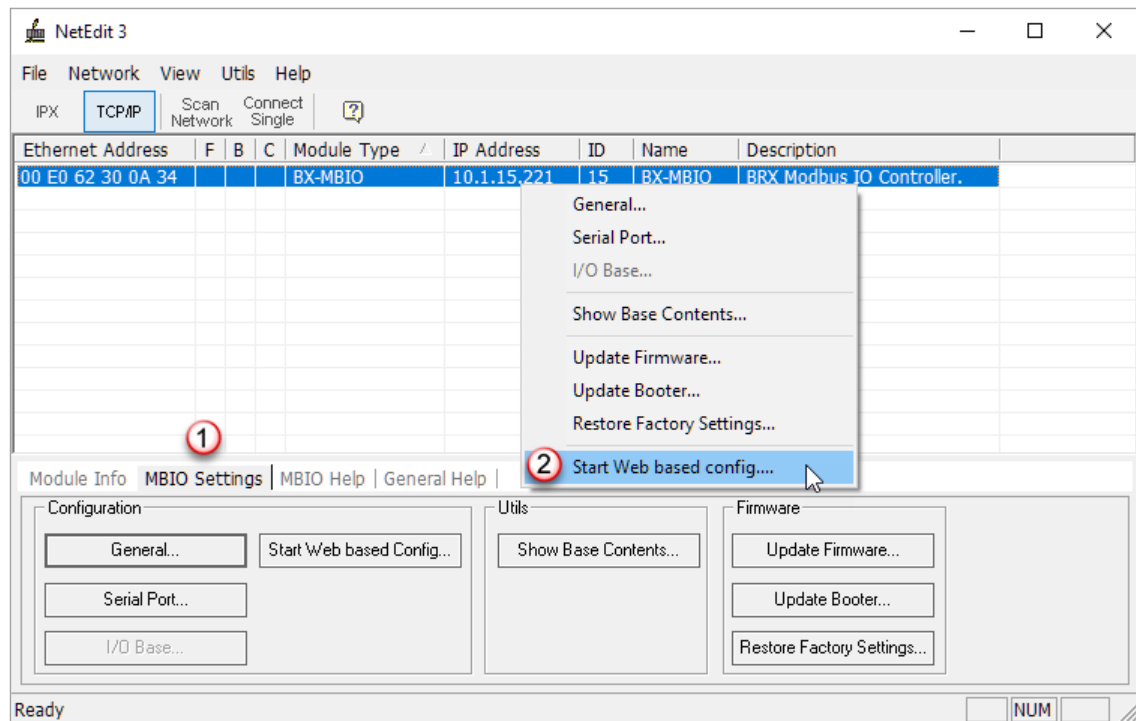

If using a web browser, enter the IP address of the BX-MBIO you want to configure in the URL address field of the web browser.

After selecting “Start Web based Config...” in NetEdit 3 or accessing the IP address of the BX-MBIO via a browser page, the following web page will open in your default Web Browser:

BX-MBIO by AutomationDirect.com	
Module Name:	BX-MBIO (a)
Module Description:	BRX Modbus IO Controller. (b)
Ethernet Address:	00 E0 62 30 0A 34 (c)
IP Setup:	Address: 10.1.15.221 Subnet: 255.255.255.0 Gateway: 0.0.0.0 (d)
Serial Port Setup:	Station: 15 115200-8-N-1-Modbus Slave-No Pre Delay (e)
Module Setup:	Setup Module Configuration (f)
I/O Mapping:	Display Modbus I/O Mapping (g)
Booter Version:	4.1.128 (h)
OS Version:	4.1.314 (i)
Firmware Updates:	Hosteng.com (j)
NetEdit Download:	http://www.hosteng.com/sw-products/netedit3.htm (k)
BRX User Manual:	http://www.automationdirect.com/pn/doc/manual/BX-MBIO (l)
BRX Spec Sheet:	http://www.automationdirect.com/pn/doc/spec/BX-MBIO (m)

BX-MBIO Configuration, continued

(a) Module Name

The user is able to change the name of the module, making it meaningful to the location or the process. Select the (a) link to change the name. The Module Name can be 255 characters long.

(b) Module Description

The user is able to change the description of the module, allowing the addition of pertinent information to the process. Select the (b) link to edit the module description. The Module Description can be 255 characters long.

Selecting the link to change the (a) Module Name or the (b) Module Description, brings up this page:

(1) Back button, returns you to the main setup page of the Web configuration page.

(2) Send button, writes the modified information to the BX-MBIO.

(3) Reset button, changes any edits back to default.

To complete editing the Module Name or Description, select the (2) Send button. Once it is complete, a dialog box will confirm “Module Data setup complete.”

(c) Ethernet Address

This field displays the MAC address of the BX-MBIO. This is a static field.

(d) IP Setup

The user is able to change the IP address, the subnet and the gateway of the module. Access the setup page by selecting the (d) link. This brings up the Set up IP Configuration page:

BX-MBIO Configuration, continued

- (1) Mode: gives you two options from a drop-down menu:
 - (i) Obtain an IP address automatically. Use only if DHCP server is available.
 - (ii) Use the following IP address
- (3) IP Address: Enter the BX-MBIO network IP address. This should be in the same family as that of the Modbus client.
- (4) Subnet Mask: Enter the Subnet Mask associated with the network to which the BX-MBIO is added.
- (5) Gateway: Enter the IP address of the network gateway.
- (6) Back button, returns you to the main setup page of the Web configuration page.
- (7) Send button, writes the modified information to the BX-MBIO.
- (8) Reset button, changes any edits back to default.

To complete editing the Set up IP Configuration, select the (6) Send button. Once it is complete, a dialog box will confirm “Set up IP Configuration complete.”

(e) Serial Port Setup

Selecting the serial port setup link brings up the Set up RS485 Port page:

Set up RS485 Port	
Station ID:	1
Baud Rate:	115200 ▼
Parity:	None ▼
Data Bits:	8 ▼
Stop Bits:	1 ▼
<input type="checkbox"/> Enable 120 Ohm Termination	
Pre-Transmit Delay (ms):	0
<input type="button" value="Back"/> <input type="button" value="Send"/> <input type="button" value="Reset"/>	

- (1) Station ID: Enter a valid station number, 1-247. Each device on the network must have a unique station ID.
- (2) Baud Rate: The rate at which the data is transmitted. The higher the number the faster the data will be transmitted. Choosing a lower value can help with issues when the data is not being received reliably. Available Baud Rate choices: 115200, 57600, 38400, 19200, 9600, 4800, 2400, 1200. This must match the baud rate of the Modbus RTU master.
- (3) Parity: The method of error detection used during transmission. Available choices: Even, Odd, None.
- (4) Data Bits: The number of bits in each character. Available choices: 7 or 8.
- (5) Stop Bits: The number of bits sent to denote the end of each character. Available choices: 1 or 2.

BX-MBIO Configuration, continued

- (6) Enable 120-ohm Termination: When enabled, a 120-ohm termination resistor is added to the BX-MBIO RS-485 circuit. Use only at the beginning and end of the RS-485 network.
 - (7) Pre-Transmit Delay (ms): Enter a time from 0 to 500ms. This allows the user to adjust the response rate based on what master is talking to it. For example, a radio may require a delay before they are ready to “receive” a packet of information.
 - (8) Back button, returns you to the main setup page of the Web configuration page.
 - (9) Send button, writes the modified information to the BX-MBIO.
 - (10) Reset button, changes any edits back to default.
 - (11) To complete editing the Serial Port Setup, select the (9) Send button. Once it is complete, a dialog box will confirm “Serial Port Setup complete.”
- (f) Module Setup

The user is able to view which expansion modules are in each slot. If Analog I/O modules are installed, the user will be able to change the module configuration. Access the setup page by selecting the (f) link. This brings up the Set up Module Configuration page. In general, the page will display a list of slot numbers and the module part number installed in that slot. Configuration fields will be available for the slot with an installed Analog I/O module.

Each displayed module part number is a hyperlink to the product insert for that module on www.AutomationDirect.com.

One example configuration used to illustrate the module setup interface comprises the following:

Slot 1: BX-05TRS

Slot 2: BX-08TR

Slot 3: BX-08NA

Slot 4: BX-04THM

Slot 5: BX-08AD-2B

Slot 6: BX-08DA-2B

Slot 7: BX-08AD-1

Slot 8: BX-08DA-1

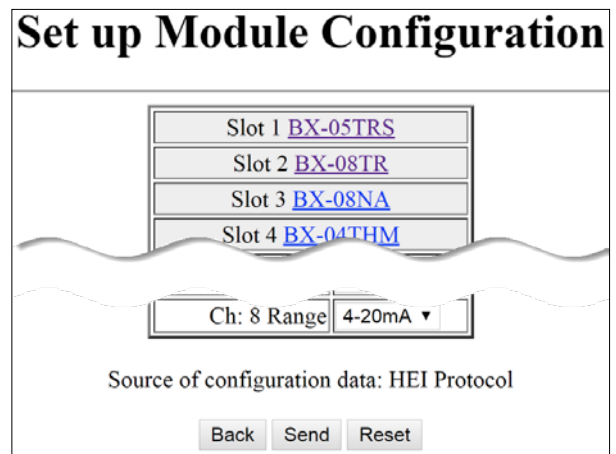

We will step through the Set up Module Configuration page for this example slot-by-slot.

Slots 1–3 (Discrete I/O modules):

In this example we have three discrete I/O modules installed. There is nothing to configure for these discrete I/O modules. All Discrete I/O expansion modules available to the BRX series work in a similar manner.

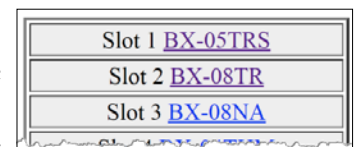

BX-MBIO Configuration, continued

Slot 4 (BX-04THM):

The BX-04THM analog temperature module is installed in slot 4 in this example. The BX-04THM module has the following configuration options:

- (i) Channels Enabled: (1–4)
- (ii) Temp Scale: Celsius or Fahrenheit.
- (iii) Burn Out Mode: Select if the Input register should read a Low or High value on burn out or if burn out detection should be disabled. Note: Burn Out Mode must be set to Disabled in order to use a Thermocouple Calibrator.
- (iv) Input Range for Channels 1 to 4: These are the settings for each channel of the analog temperature module. Available choices are: J, K, E, R, S, T, B, N, C, 0-39mV, +/-39mV, +/-78mV, 0-156mV, +/-156mV, 0-1.25V.

Slot 4 BX-04THM	
Channels Enabled	Ch 1-4 ▼
Temp Scale	Fahrenheit ▼
Burn Out Mode	Low Side ▼
Ch: 1 Range	J ▼
Ch: 2 Range	J ▼
Ch: 3 Range	J ▼
Ch: 4 Range	J ▼

Slot 5 (BX-08AD-2B):

The BX-08AD-2B is installed in slot 5 in this example. The BX-08AD-2B module has the following configuration options:

- (i) Channels Enabled: (1–8)
- (ii) Range for Input Channels 1 to 8: There is a configuration field for each channel. Available choices are: 0-5V, 0-10V, +/-5V, +/-10V.

Slot 5 BX-08AD-2B	
Channels Enabled	Ch 1-8 ▼
Ch: 1 Range	0-10V ▼
Ch: 2 Range	0-10V ▼
Ch: 3 Range	0-10V ▼
Ch: 4 Range	0-10V ▼
Ch: 5 Range	0-10V ▼
Ch: 6 Range	0-10V ▼
Ch: 7 Range	0-10V ▼
Ch: 8 Range	0-10V ▼

Slot 6 (BX-08DA-2B):

The BX-08DA-2B is installed in slot 6 of this example. The BX-08DA-2B module has the following configuration options:

- (i) Channels Enabled: (1–8)
- (ii) Range for Output Channels 1 to 8: There is a configuration field for each channel. Available choices are: 0–5V, 0–10V, ±5V, ±10V.

Slot 6 BX-08DA-2B	
Channels Enabled	Ch 1-8 ▼
Ch: 1 Range	0-10V ▼
Ch: 2 Range	0-10V ▼
Ch: 3 Range	0-10V ▼
Ch: 4 Range	0-10V ▼
Ch: 5 Range	0-10V ▼
Ch: 6 Range	0-10V ▼
Ch: 7 Range	0-10V ▼
Ch: 8 Range	0-10V ▼

BX-MBIO Configuration, continued

Slot 7 (BX-08AD-1):

The BX-08AD-1 is installed in slot 7 of this example. The BX-08AD-1 module has the following configuration options:

- (i) Channels Enabled: (1–8)
- (ii) Range for Input Channels 1 to 8: There is a configuration field for each channel. Available choices are: 0–20mA, 4–20mA.

Slot 7 BX-08AD-1	
Channels Enabled	Ch 1-8 ▾
Ch: 1 Range	4-20mA ▾
Ch: 2 Range	4-20mA ▾
Ch: 3 Range	4-20mA ▾
Ch: 4 Range	4-20mA ▾
Ch: 5 Range	4-20mA ▾
Ch: 6 Range	4-20mA ▾
Ch: 7 Range	4-20mA ▾
Ch: 8 Range	4-20mA ▾

Slot 8 (BX-08DA-1):

The BX-08DA-1 is installed in slot 8 of the sample drop. The BX-08DA-1 module has the following configuration options:

- (i) Channels Enabled: (1–8)
- (ii) Range for Output Channels 1 to 8: There is a configuration field for each channel. Available choices are: 0–20mA, 4–20mA.

Slot 8 BX-08DA-1	
Channels Enabled	Ch 1-8 ▾
Ch: 1 Range	4-20mA ▾
Ch: 2 Range	4-20mA ▾
Ch: 3 Range	4-20mA ▾
Ch: 4 Range	4-20mA ▾
Ch: 5 Range	4-20mA ▾
Ch: 6 Range	4-20mA ▾
Ch: 7 Range	4-20mA ▾
Ch: 8 Range	4-20mA ▾

The Back button returns you to the main setup page of the Web configuration page, the Send button writes the modified information to the BX-MBIO, and the Reset button changes any edits back to default.

To complete editing the Setup Module Configuration, select the Send button. The BX-MBIO will be rebooted in order to use the new configuration. A warning and confirmation message box will be displayed:

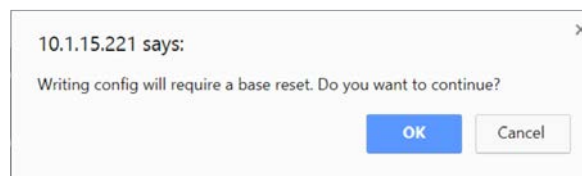

If you press the OK button, the new configuration will be written to the BX-MBIO.



WARNING: Output states are not retained when a new configuration is written to the BX-MBIO. Only authorized persons should write a configuration.

Once the write is complete, a dialog box will confirm “Setup complete.”

BX-MBIO Configuration, continued

(g) I/O Mapping

The Modbus I/O Mapping page is viewable by selecting the (g) link. This page displays the Modbus I/O addressing associated with each slot plus error and device information.

Based on the example set of installed modules listed previously, the following Modbus I/O Mapping table is displayed.

Modbus I/O Mapping				
Description	Inputs Offset: 100000	Coils Offset: 0	Input Regs Offset: 300000	Holding Regs Offset: 400000
Slot 1 BX-05TRS				
5 Bit Outputs		1 - 8		402001 - 402001 LO
Slot 2 BX-08TR				
8 Bit Outputs		9 - 16		402001 HI - 402001
Slot 3 BX-08NA				
8 Bit Inputs	100001 - 100008		302001 - 302001 LO	411625 - 411625 LO
Slot 4 BX-04THM				
24 Bit Inputs	100009 - 100032		302001 HI - 302002	411625 HI - 411626
4 Word Inputs			300001 - 300004	412252 - 412255
Slot 5 BX-08AD-2B				
24 Bit Inputs	100033 - 100056		302003 - 302004 LO	411627 - 411628 LO
8 Word Inputs			300005 - 300012	412256 - 412263
Slot 6 BX-08DA-2B				
24 Bit Inputs	100057 - 100080		302004 HI - 302005	411628 HI - 411629
8 Word Outputs				400001 - 400008
Slot 7 BX-08AD-1				
24 Bit Inputs	100081 - 100104		302006 - 302007 LO	411630 - 411631 LO
8 Word Inputs			300013 - 300020	412264 - 412271
Slot 8 BX-08DA-1				
24 Bit Inputs	100105 - 100128		302007 HI - 302008	411631 HI - 411632
8 Word Outputs				400009 - 400016
Error Information (write 0 to clear):				
Module Error				410001
Bit Per Slot Error				410002
Device Information:				
Firmware Version			307001 - 307006	419251 - 419256
Millisecond Tick			307007 - 307008	419257 - 419258
MAC Address			307016 - 307018	419266 - 419268
DIP Switches			307022	419272
IP Addressing			307036 - 307041	419286 - 419291
Additional Mapping Information				
<input type="button" value="Back"/>				

Description column:

Displays the slot number, the module installed in that slot and the Input/Output bits and/or words used by the module. The module part number is a link to the module insert.

BX-MBIO Configuration, continued

Inputs column:

Displays the discrete input addressing. The offset is 100000. If a module has discrete input addresses associated with it, the Modbus discrete input address range is shown. For example, in slot 3, the BX-08NA module is mapped to 8 discrete input addresses, 100001 – 100008.

Coils column:

Displays the discrete output addressing. The offset is 0. If a module has discrete output addresses associated with it, the Modbus discrete output range is shown. For example, in slot 1, the BX-05TRS module is mapped to 5 discrete output addresses. However, the addressing is mapped in byte ranges, which means the module takes up 8 bits, 1 – 8. For this module, BX-05TRS, the user will use the first 5 bits of the addressed range, 1-5.

Input Regs column:

Displays the input register addressing. The offset is 300000. If a module has input registers associated with it, the Modbus input register range is shown. Input registers are typically used to store analog input values. Input registers are typically read only registers. For example, in slot 4, the BX-04THM module is mapped to 24 discrete input bits and 4 input words. These 4 words are mapped to 4 input registers, 300001 – 300004, one word for each input channel. In this case, data read from channel 1 of the BX-04THM is stored in Modbus input register 300001.

Discrete inputs are also mapped to input registers. For example BX-08NA, an 8-point input module, mapped to 302001 LO. This is the lower 8 bits of the 16-bit word 302001.

Analog and Temperature modules have 24 discrete inputs used as error status flags. These are also mapped to input registers. For example, BX-04THM has 24 discrete input bits mapped to 302001 HI to 302002 input registers. This is the top 8 bits of 302001 and 16 bits of 302002.

Refer to Chapter 8, “BRX Analog I/O Expansion Modules,” for information on the function of the 24 bits associated with Analog I/O and Temperature modules.

Holding Regs column:

Displays the holding register addressing. The offset is 400000. If a module has holding registers associated with it, the Modbus holding register range is shown. Holding registers are typically used to store analog output values or to store variable data used by the system. Holding registers are typically read/write registers. For example, in slot 6, the BX-08DA-2B module is mapped to 24 discrete input bits and 8 output words. These 8 words are mapped to 8 holding registers, 400001 – 400008, one word for each output channel. In this case, data written to channel 1 of the BX-08DA-2B is stored in Modbus holding register 400001.

Discrete inputs are also mapped to holding registers. For example BX-08NA, an 8-point input module, mapped to 411625 LO. This is the lower 8 bits of the 16-bit word 411625.

Analog and Temperature modules have 24 discrete inputs used as error status flags. These are also mapped to holding registers. For example, BX-04THM has 24 discrete input bits mapped to 411625 HI to 411626 holding registers. This is the top 8 bits of 411625 and 16 bits of 411626.

Refer to Chapter 8, “BRX Analog I/O Expansion Modules,” for information on the function of the 24 bits associated with Analog I/O and Temperature modules.

BX-MBIO Configuration, continued

Extra information available in the Modbus I/O mapping table:

Addressing of available error information is mapped to holding registers. Module Error and Bit Per Slot Error can be read from holding registers 410001 and 410002, for this setup. To clear an error, write a value of 0 to the corresponding holding register.

BX-MBIO Diagnostic Information (write 0 to clear):		
Data	Input Registers	Holding Registers
Module Error		410001
Bit Per Slot Error		410002
Reserved*		410003 – 410006
Link Monitor Timeout		410007

* This section is for use by the MBIO operating system. Do not write to this area.

Device Information is comprised of a block of 40 words. A Modbus client (master) can read the entire block or a specific portion.

BX-MBIO Device Information		
Data	Input Registers	Holding Registers
Firmware Version	307001 – 307006	419251 – 419256
Millisecond Tick	307007 – 307008	419257 – 419258
Reserved*	307009 – 307015	419259 – 419265
MAC Address	307016 – 307018	419266 – 419268
Reserved*	307019 – 307022	419269 – 419271
DIP Switches	307022	419272
Reserved*	307023 – 307035	419273 – 419285
IP Addressing	307036 – 307041	419286 – 419291

* This section is for use by the MBIO operating system. Do not write to this area.

The Device Information displays items from those available in the table above. These are as follows:

- (1) Firmware Version: six words hold information on the Firmware and Booter version of the BX-MBIO, mapped to input registers 307001-307006 and to holding registers 419251-419256.

BX-MBIO Firmware and Booter versions:				
Firmware: 4.1.299 Booter: 4.1.128				
Modbus Input Register	Modbus Holding Register	MAC address value viewed as Signed Decimal		
307001	419251	4	Hold the Firmware version	least significant word
307002	419252	1		
307003	419253	299		most significant word
307004	419254	4	Hold the Booter version	least significant word
307005	419255	1		
307006	419256	128		most significant word

BX-MBIO Configuration, continued

- (2) Millisecond Tick: Two words hold information on the Millisecond Tick clock of the BX-MBIO, which could be used to indicate communications is active with the BX-MBIO, mapped to input registers 307007-307008 and to holding registers 419257-419258.

BX-MBIO Millisecond Tick			
Modbus Input Register	Modbus Holding Register	MAC address value viewed as HEX	
307007	419257	0xE000	least significant word
307008	419258	0x3062	most significant word

- (3) MAC Address: Three words hold information on the MAC address of the BX-MBIO, mapped to input registers 307016-307018 and to holding registers 419266-419268.

BX-MBIO MAC address: 00:E0:62:30:0A:34			
Modbus Input Register	Modbus Holding Register	MAC address value viewed as HEX	
307016	419266	0xE000	least significant word
307017	419267	0x3062	
307018	419268	0x340A	most significant word

- (4) DIP Switches: One word holds information about the position of the DIP Switches of the BX-MBIO, which provides the status of the DIP switch position, mapped to input register 307022 and holding register 419272.

BX-MBIO DIP Switch: Example with DIP Switches 0 to 3 ON, serial port Station # 15			
Modbus Input Register	Modbus Holding Register	DIP Switch value viewed as Unsigned Decimal	DIP Switch value viewed in Binary
307022	419272	15	0000 0000 0000 1111 msb -----lsb

- (5) IP Addressing: Six words hold information about the IP address, the Gateway address, and the Subnet mask of the BX-MBIO, mapped to input registers 307036-307041 and to holding registers 419286-419291.

BX-MBIO IP and Subnet address: IP: 10.1.15.221 Gateway: 192.168.2.1 Subnet: 255.255.255.0					
Modbus Input Register	Modbus Holding Register	MAC address value viewed in HEX			
307036	419286	0x010A	where: 01 = 1, 0A = 10	IP Address	least significant word
307037	419287	0xDD0F	where: DD = 221, 0F = 15		most significant word
307038	419288	0xA8C0	where: A8 = 168, C0 = 192	Gateway address	least significant word
307039	419289	0x0102	where: 01 = 1, 02 = 2		most significant word
307040	419290	0xFFFF	where: FF = 255, FF = 255	Subnet mask	least significant word
307041	419291	0x00FF	where: 00 = 0, FF = 255		most significant word

BX-MBIO Configuration, continued

(h) Booter Version

This field displays the current booter version of the BX-MBIO controller. This is a fixed field. It is necessary to use the NetEdit 3 utility to update the booter.

(i) OS Version

This field displays the current OS version of the BX-MBIO controller. This is a fixed field. It is necessary to use the NetEdit 3 utility to update the OS.

(j) Firmware Updates

This field contains a link to the firmware download location on the HOST Engineering website: Hosteng.com (<http://www.hosteng.com/hw-products/firmware.htm>).

(k) NetEdit Download

This field contains a link to the NetEdit 3 utility download page: <http://www.hosteng.com/sw-products/netedit3.htm>.

(l) BRX User Manual

This field contains a link to the BRX user manual web page: <http://www.automationdirect.com/pn/doc/manual/BX-MBIO>.

(m) BRX Spec Sheet

This field contains a link to the BX-MBIO-M insert page: <http://www.automationdirect.com/pn/doc/spec/BX-MBIO>.

List of modules supported by BX-MBIO						
Module	Number of Points		Address Offset	Bytes Used	Function Codes	Example Addressing: Module Installed in Slot 1
	In	Out				
Discrete IO						
BX-08NF3	8		1-8	1	02	100001-100008
BX-08ND3	8		1-8	1	02	100001-100008
BX-08NB	8		1-8	1	02	100001-100008
BX-08NA	8		1-8	1	02	100001-100008
BX-08SIM	8		1-8	1	02	100001-100008
BX-12ND3	12		1-12 ¹	2	02	100001-100016 ¹
BX-12NB	12		1-12 ¹	2	02	100001-100016 ¹
BX-12NA	12		1-12 ¹	2	02	100001-100016 ¹
BX-16NF3	16		1-16	2	02	100001-100016
BX-16ND3	16		1-16	2	02	100001-100016
BX-16NB	16		1-16	2	02	100001-100016
BX-16NA	16		1-16	2	02	100001-100016
BX-32ND3	32		1-16, 17-32	4	02	100001-100016 100017-100032
BX-05TRS		5	1-5 ²	1	01, 05, 15	000001-000008 ²
BX-05TRS-1		5	1-5 ²	1	01, 05, 15	000001-000008 ²
BX-08TD1		8	1-8	1	01, 05, 15	000001-000008
BX-08TD2		8	1-8	1	01, 05, 15	000001-000008
BX-08TR		8	1-8	1	01, 05, 15	000001-000008

Table continued on next page

BX-MBIO Configuration, continued

List of modules supported by BX-MBIO (continued)						
Module	Number of Points		Address Offset	Bytes Used	Function Codes	Example Addressing: Module Installed in Slot 1
	In	Out				
BX-08TRZ		8	1–8	1	01, 05, 15	000001–000008
BX-08TA		8	1–8	1	01, 05, 15	000001–000008
BX-12TD1		12	1–12 ¹	2	01, 05, 15	000001–000016 ¹
BX-12TD2		12	1–12 ¹	2	01, 05, 15	000001–000016 ¹
BX-12TR		12	1–12 ¹	2	01, 05, 15	000001–000016 ¹
BX-12TA		12	1–12 ¹	2	01, 05, 15	000001–000016 ¹
BX-16TD1		16	1–16	2	01, 05, 15	000001–000016
BX-16TD2		16	1–16	2	01, 05, 15	000001–000016
BX-16TF2		16	1–16	2	01, 05, 15	000001–000016
BX-16TR		16	1–16	2	01, 05, 15	000001–000016
BX-16TRZ		16	1–16	2	01, 05, 15	000001–000016
BX-32TD1		32	1–16, 17–32	4	01, 05, 15	100001–100016 100017–100032
BX-32TD2		32	1–16, 17–32	4	01, 05, 15	100001–100016 100017–100032
BX-08CD3R	4	4	Input: 1–4 ³ Output: 1–4 ³	1 1	02 01, 05, 15	100001–100008 ³ 000001–000008 ³
BX-12CD3D1	8	4	Input: 1–8 Output: 1–4 ³	1 1	02 01, 05, 15	100001–100008 000001–000008 ³
BX-12CD3D2	8	4	Input: 1–8 Output: 1–4 ³	1 1	02 01, 05, 15	100001–100008 000001–000008 ³
BX-16CD3D1	8	8	Input: 1–8 Output: 1–8	1 1	02 01, 05, 15	100001–100008 000001–000008
BX-16CD3D2	8	8	Input: 1–8 Output: 1–8	1 1	02 01, 05, 15	100001–100008 000001–000008
BX-12CF3F2	8	8	Input: 1–8 Output: 1–8	1 1	02 01, 05, 15	100001–100008 000001–000008
Analog IO						
BX-04ADM-1	4		Data Words: 1–4 Status Flags ⁴ : 1–24	2 (per word) 3	04 02	300001–300004 100001–100024
BX-04AD-1	4		Data Words: 1–4 Status Flags ⁴ : 1–24	2 (per word) 3	04 02	300001–300004 100001–100024
BX-08AD-1	8		Data Words: 1–8 Status Flags ⁴ : 1–24	2 (per word) 3	04 02	300001–300008 100001–100024
BX-16AD-1	16		Data Words: 1–16 Status Flags ⁴ : 1–24	2 (per word) 3	04 02	300001–300016 100001–100024
BX-04AD-2B	4		Data Words: 1–4 Status Flags ⁴ : 1–24	2 (per word) 3	04 02	300001–300004 100001–100024
BX-08AD-2B	8		Data Words: 1–8 Status Flags ⁴ : 1–24	2 (per word) 3	04 02	300001–300008 100001–100024
BX-16AD-2B	16		Data Words: 1–16 Status Flags ⁴ : 1–24	2 (per word) 3	04 02	300001–300016 100001–100024
BX-04AD-3	4		Data Words: 1–4 Status Flags: 1–8	2 (per word) 1	04 02	300001–300004 100001–100008
BX-08AD-3	8		Data Words: 1–8 Status Flags: 1–8	2 (per word) 1	04 02	300001–300008 100001–100008
BX-04DA-1		4	Data Words: 1–4 Status Flags ⁴ : 1–24	2 (per word) 3	03, 06, 16 02	400001–400004 100001–100024

Table continued on next page

BX-MBIO Configuration, continued

List of modules supported by BX-MBIO (continued)						
Module	Number of Points		Address Offset	Bytes Used	Function Codes	Example Addressing: Module Installed in Slot 1
	In	Out				
BX-08DA-1		8	Data Words: 1–8 Status Flags ⁴ : 1–24	2 (per word) 3	03, 06, 16 02	400001–400008 100001–100024
BX-04DA-2B		4	Data Words: 1–4 Status Flags ⁴ : 1–24	2 (per word) 3	03, 06, 16 02	400001–400004 100001–100024
BX-08DA-2B		8	Data Words: 1–8 Status Flags ⁴ : 1–24	2 (per word) 3	03, 06, 16 02	400001–400008 100001–100024
BX-04DA-3		4	Data Words: 1–4 Status Flags: 1–8	2 (per word) 1	03, 06, 16 02	400001–400004 100001–100008
BX-08DA-3		8	Data Words: 1–8 Status Flags: 1–8	2 (per word) 1	03, 06, 16 02	400001–400008 100001–100008
BX-2AD2DA-1	2	2	Input Data Words: 1–2 Output Data Words: 1–2 Status Flags ⁴ : 1–24	2 (per word) 2 (per word) 3	04 03, 06, 16 02	300001–300002 400001–400002 100001–100024
BX-4AD2DA-1	4	2	Input Data Words: 1–4 Output Data Words: 1–2 Status Flags ⁴ : 1–24	2 (per word) 2 (per word) 3	04 03, 06, 16 02	300001–300004 400001–400002 100001–100024
BX-2AD2DA-2B	2	2	Input Data Words: 1–2 Output Data Words: 1–2 Status Flags ⁴ : 1–24	2 (per word) 2 (per word) 3	04 03, 06, 16 02	300001–300002 400001–400002 100001–100024
BX-4AD2DA-2B	4	2	Input Data Words: 1–4 Output Data Words: 1–2 Status Flags ⁴ : 1–24	2 (per word) 2 (per word) 3	04 03, 06, 16 02	300001–300004 400001–400002 100001–100024
BX-2AD2DA-3	2	2	Input Data Words: 1–2 Output Data Words: 1–2 Status Flags: 1–8	2 (per word) 2 (per word) 1	04 03, 06, 16 02	300001–300002 400001–400002 100001–100008
BX-4AD4DA-3	4	4	Input Data Words: 1–4 Output Data Words: 1–4 Status Flags: 1–8	2 (per word) 2 (per word) 1	04 03, 06, 16 02	300001–300004 400001–400002 100001–100008
Temperature						
BX-04THM	4		Data Words: 1–4 Status Flags (Bits) ⁴ : 1–24	2 (per word) 3	04 02	300001–300004 100001–100024
BX-08THM	8		Data Words: 1–8 Status Flags (Bits) ⁴ : 1–24	2 (per word) 3	04 02	300001–300008 100001–100024
BX-06RTD	6		Data Words: 1–6 Status Flags (Bits) ⁴ : 1–24	2 (per word) 3	04 02	300001–300006 100001–100024
BX-04UT	4		Data Words: 1–4 Status Flags (Bits): 1–16	2 (per word) 2	04 02	300001–300004 100001–100016
BX-08UT	8		Data Words: 1–8 Status Flags (Bits): 1–16	2 (per word) 2	04 02	300001–300008 100001–100016
BX-08NTC	8		Data Words: 1–8 Status Flags (Bits) ⁴ : 1–24	2 (per word) 3	04 02	300001–300008 100001–100024
<i>Table continued on next page</i>						

BX-MBIO Configuration, continued

List of modules supported by BX-MBIO (continued)						
Module	Number of Points		Address Offset	Bytes Used	Function Codes	Example Addressing: Module Installed in Slot 1
	In	Out				
BX-4RTD4DA-1	4	4	Input Data Words: 1–4 Output Data Words: 1–4 Status Flags (Bits) ⁴ : 1–24	2 (per word) 2 (per word) 3	04 03, 06, 16 02	300001–300004 400001–400002 100001–100024
BX-4THM4DA-1	4	4	Input Data Words: 1–4 Output Data Words: 1–4 Status Flags (Bits) ⁴ : 1–24	2 (per word) 2 (per word) 3	04 03, 06, 16 02	300001–300004 400001–400002 100001–100024
BX-4UT4DA-3	4	4	Input Data Words: 1–4 Output Data Words: 1–4 Status Flags: 1–8	2 (per word) 2 (per word) 1	04 03, 06, 16 02	300001–300004 400001–400002 100001–100008
BX-4UT4TD1	4	4	Input Data Words: 1–4 Output Data Words: 1–4 Status Flags: 1–8	2 (per word) 2 (per word) 1	04 03, 06, 16 02	300001–300004 400001–400002 100001–100008
BX-4UT4TD2	4	4	Input Data Words: 1–4 Output Data Words: 1–4 Status Flags: 1–8	2 (per word) 2 (per word) 1	04 03, 06, 16 02	300001–300004 400001–400002 100001–100008
BX-4UT4TR	4	4	Input Data Words: 1–4 Output Data Words: 1–4 Status Flags: 1–8	2 (per word) 2 (per word) 1	04 03, 06, 16 02	300001–300004 400001–400002 100001–100008

1. *The 12-point modules use 12 addressing bits, but they are mapped to 16 bits (two bytes). Addressing follows a Byte boundary.*
2. *The 5-point module uses 5 addressing bits, mapped to 8 bits (one byte). Addressing follows a Byte boundary.*
3. *The 8- and 12-point combo modules with four input or four output points use 4 addressing bits, but are mapped to 8 bits (one byte). Addressing follows a Byte boundary.*
4. *Module uses 24 bits as Status Flags. These are mapped to 24 addressing bits (3 bytes). Addressing follows a Byte boundary.*

Troubleshooting with Modbus Poll

Detailed Example: Using the Modbus Poll Utility to Verify Communications With BX-MBIO

This example explains how to use the Modbus client utility, Modbus Poll, to establish communications with a BX-MBIO Modbus server (slave) and read and write information related to the discrete and analog I/O modules connected to the BX-MBIO.

For this test, the following hardware will be used:

- Slot 0: BX-MBIO-M
- Slot 1: BX-05TRS
- Slot 2: BX-08TR
- Slot 3: BX-08NA
- Slot 4: BX-04THM
- Slot 5: BX-08AD-2B
- Slot 6: BX-08DA-2B
- Slot 7: BX-08AD-1
- Slot 8: BX-08DA-1

Troubleshooting with Modbus Poll, continued

Start by wiring the modules to provide live data for the test:

1. Wire the BX-08TR to the BX-08NA. When an output point is turned on, the corresponding input will turn on.
2. Wire the BX-08AD-2B to the BX-08DA-2B and wire the BX-08AD-1 to the BX-08DA-1. When a value is written to an analog output channel, the corresponding input channel should read a value that is approximately the same as the output value. For example, if a value of 32750 is written to BX-08DA-1, we would expect the BX-08AD-1 to read a value of 32750 or very close to it. Note that the values may not be identical due to the nature of analog I/O.

Connect the BX-MBIO to the same network switch as the PC running the Modbus Poll utility. It is also possible to connect a PC Ethernet port directly to the BX-MBIO. Apply power to the unit.

Open the NetEdit 3 utility and select the BX-MBIO on the list. Under the MBIO Settings table, click on the General button to configure the IP address and the subnet mask:

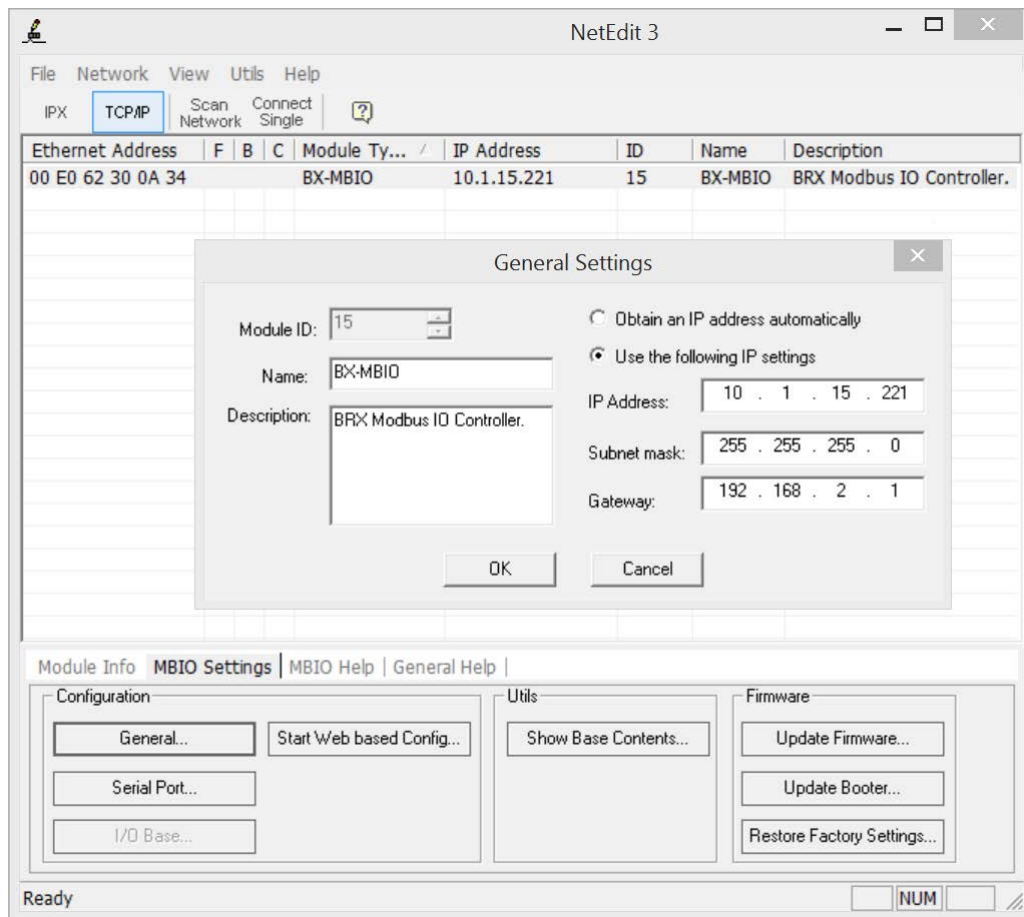

From the example above, the test BX-MBIO is configured with IP address of 10.1.15.221 and a subnet mask of 255.255.255.0. If needed, a Gateway address can be configured here.

Troubleshooting with Modbus Poll, continued

Using NetEdit 3, select the Start Web based Config button to open the Web based configuration page, as shown below:

BX-MBIO by AutomationDirect.com	
Module Name:	BX-MBIO
Module Description:	BRX Modbus IO Controller.
Ethernet Address:	00 E0 62 30 0A 34
IP Setup:	Address: 10.1.15.221 Subnet: 255.255.255.0 Gateway: 0.0.0.0
Serial Port Setup:	Station: 15 115200-8-N-1-Modbus Slave-No Pre Delay
Module Setup:	Setup Module Configuration
I/O Mapping:	Display Modbus I/O Mapping
Booter Version:	4.1.128
OS Version:	4.1.314
Firmware Updates:	Hosteng.com
NetEdit Download:	http://www.hosteng.com/sw-products/netedit3.htm
BRX User Manual:	http://www.automationdirect.com/pn/doc/manual/BX-MBIO
BRX Spec Sheet:	http://www.automationdirect.com/pn/doc/spec/BX-MBIO

Open the Module setup by clicking on the Setup Module Configuration link. This page displays each of the modules connected to the BX-MBIO, as explained on page 15-24. Edit the configuration of the analog modules to meet your test requirements.

For this test:

1. Slots 1 to 3 are discrete I/O and do not need to be configured.
2. Slot 4, BX-08THM: Enabled 4 channels, all for type J thermocouple.
3. Slot 5, BX-08AD-2B: Enabled 8 channels, all for 0–10 VDC.
4. Slot 6, BX-08DA-2B: Enabled 8 channels, all for 0–10 VDC.
5. Slot 7, BX-08AD-1: Enabled 8 channels, all for 4–20 mA.
6. Slot 8, BX-08DA-1: Enabled 8 channels, all for 4–20 mA.

Once edits are made, click on the Send button to write the new configuration to the flash memory.

At this point, we have a BX-MBIO that is powered up and available on the network with a proper IP address. The discrete and analog I/O modules are properly installed and the analog I/O have been configured.

Troubleshooting with Modbus Poll, continued

From the main BX-MBIO Web configuration page select the Display Modbus I/O Mapping link. The following chart shows the Modbus mapping for each module.

Modbus I/O Mapping				
Description	Inputs Offset: 100000	Coils Offset: 0	Input Regs Offset: 300000	Holding Regs Offset: 400000
Slot 1 BX-05TRS				
5 Bit Outputs		1 - 8		402001 - 402001 LO
Slot 2 BX-08TR				
8 Bit Outputs		9 - 16		402001 HI - 402001
Slot 3 BX-08NA				
8 Bit Inputs	100001 - 100008		302001 - 302001 LO	411625 - 411625 LO
Slot 4 BX-04THM				
24 Bit Inputs	100009 - 100032		302001 HI - 302002	411625 HI - 411626
4 Word Inputs			300001 - 300004	412252 - 412255
Slot 5 BX-08AD-2B				
24 Bit Inputs	100033 - 100056		302003 - 302004 LO	411627 - 411628 LO
8 Word Inputs			300005 - 300012	412256 - 412263
Slot 6 BX-08DA-2B				
24 Bit Inputs	100057 - 100080		302004 HI - 302005	411628 HI - 411629
8 Word Outputs				400001 - 400008
Slot 7 BX-08AD-1				
24 Bit Inputs	100081 - 100104		302006 - 302007 LO	411630 - 411631 LO
8 Word Inputs			300013 - 300020	412264 - 412271
Slot 8 BX-08DA-1				
24 Bit Inputs	100105 - 100128		302007 HI - 302008	411631 HI - 411632
8 Word Outputs				400009 - 400016
Error Information (write 0 to clear):				
Module Error				410001
Bit Per Slot Error				410002
Device Information:				
Firmware Version			307001 - 307006	419251 - 419256
Millisecond Tick			307007 - 307008	419257 - 419258
MAC Address			307016 - 307018	419266 - 419268
DIP Switches			307022	419272
IP Addressing			307036 - 307041	419286 - 419291
Additional Mapping Information				

We will use the mapping in Modbus Poll to read/write data.

For this test we will use the following addresses:

Slot 1: BX-05TRS. Modbus coils 1–8.

Slot 2: BX-08TR. Modbus coils 9–16.

Slot 3: BX-08NA. Modbus discrete inputs 100001–100008.

When Coil 9 is turned on, discrete input 100001 will come on.

Troubleshooting with Modbus Poll, continued

Slot 4: BX-04THM.

Modbus Input Registers 300001–300004. If a type J thermocouple is wired to channel 1 to read room temperature, the reading will be read in Input Register 300001. There are 24 status flag bits associated with this module mapped to discrete inputs 100009–100032. The table below shows the addressing for the status flags.

Error Flag Specifications									
	MSB							LSB	
1st Byte of status flags						100011	100010	100009	
Module Status	-	-	-	-	-	Data Not Valid	Missing 24VDC	Self Test Failed	
2nd Byte of status flags						100020	100019	100018	100017
Channel Out of Range	-	-	-	-	Channel 4	Channel 3	Channel 2	Channel 1	
3rd Byte of status flags						100028	100027	100026	100025
Channel Open (Burn Out)	-	-	-	-	Channel 4	Channel 3	Channel 2	Channel 1	

Slot 5:

BX-08AD-2B. Modbus Input Registers 300005–300012. If a transducer is wired to channel 1, the value is read in Input Register 300005. There are 24 status flag bits associated with this module, mapped to discrete inputs 100033–100056. The table below shows the addressing for the status flags.

Error Flag Specifications									
	MSB							LSB	
1st Byte of status flags						100035	100034	100033	
Module Status	-	-	-	-	-	Data Not Valid	Missing 24VDC	Self Test Failed	
2nd Byte of status flags									
	100048	100047	100046	100045	100044	100043	100042	100041	
Channel Out of Range	Channel 8	Channel 7	Channel 6	Channel 5	Channel 4	Channel 3	Channel 2	Channel 1	
3rd Byte of status flags									
Unused	-	-	-	-	-	-	-	-	

Slot 6:

BX-08DA-2B. Modbus Holding Registers 400001–400008. If channel 1 is used to drive the speed reference of a VFD, the value is written to Holding Register 400001. There are 24 status flag bits associated with this module, mapped to discrete inputs 100057–100080. The table below shows the addressing for the status flags.

Error Flag Specifications									
	MSB							LSB	
1st Byte of status flags						100059	100058	100057	
Module Status	-	-	-	-	-	Data Not Valid	Missing 24VDC	Self Test Failed	
2nd Byte of status flags									
Unused	-	-	-	-	-	-	-	-	
3rd Byte of status flags									
Unused	-	-	-	-	-	-	-	-	

Troubleshooting with Modbus Poll, continued

Slot 7:

BX-08AD-1. Modbus Input Registers 300013–300020. If a transducer is wired to channel 1, the value is read in Input Register 300013. There are 24 status flag bits associated with this module, mapped to discrete inputs 100081–100104. The table below shows the addressing for the status flags.

Error Flag Specifications								
	MSB							LSB
1st Byte of status flags						100083	100082	100081
Module Status	-	-	-	-	-	Data Not Valid	Missing 24VDC	Self Test Failed
2nd Byte of status flags								
	100096	100095	100094	100093	100092	100091	100090	100089
Channel Open (Broken Transmitter)	Channel 8	Channel 7	Channel 6	Channel 5	Channel 4	Channel 3	Channel 2	Channel 1
3rd Byte of status flags								
Unused	-	-	-	-	-	-	-	-

Slot 8:

BX-08DA-1. Modbus Holding Registers 400009-400016. If channel 1 is used to drive the speed reference of a VFD, the value is written to Holding Register 400009. There are 24 status flag bits associated with this module, mapped to discrete inputs 100105-100128. The table below shows the addressing for the status flags.

Error Flag Specifications								
	MSB							LSB
1st Byte of status flags						100107	100106	100105
Module Status	-	-	-	-	-	Data Not Valid	Missing 24VDC	Self Test Failed
2nd Byte of status flags								
Unused	-	-	-	-	-	-	-	-
3rd Byte of status flags								
Unused	-	-	-	-	-	-	-	-

Ready to connect with the Modbus Poll

We have all the information we need to connect with our target BX-MBIO, as summarized below:

1. IP Address of BX-MBIO: 10.1.15.221
2. Coil addresses: 000001–000016. This covers the two relay output modules.
3. Discrete inputs: 100001–100128. This covers the discrete input addresses and the set of 24 status flags for each of the 5 analog I/O and temperature modules.
4. Input Registers: 300001–300020. This covers the analog and temperature input modules.
5. Holding Registers: 400001–400016. This covers the analog output modules.

With Modbus Poll running, we will start by setting up the read and write blocks for each group of addressing.

Troubleshooting with Modbus Poll, continued

For coils related to BX-05TRS and BX-08TR, use the Mbpoll1 window. Write to coils 1 to 16:

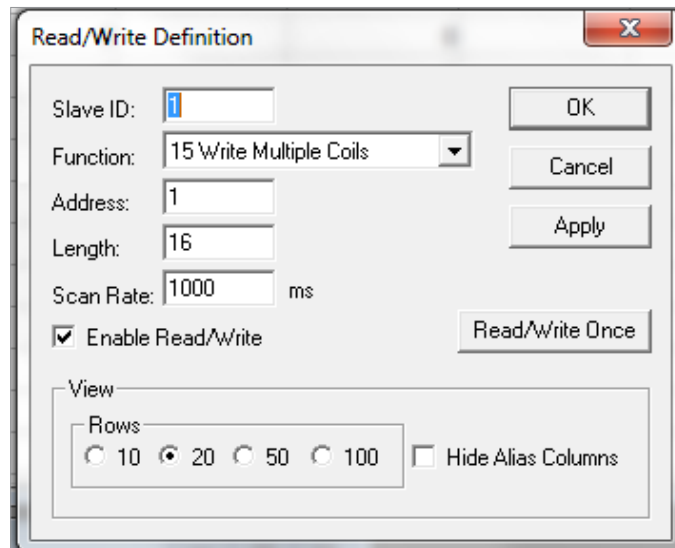

1. From the Display menu, select PLC Address (Base 1).
2. From the Setup menu, select Read/Write Definition.
 - a. Slave ID = 1, change to match BX-MBIO module ID.
 - b. Function = 15 Write Multiple Coils
 - c. Address = 1
 - d. Length = 16
 - e. Scan rate = 1000ms (user preference)
 - f. View rows = 20 (user preference)

For discrete inputs related to the BX-08NA and the four groups of 24 status flags related to the analog and temperature modules, use the Mbpoll2 window. Read from discrete inputs 100001 to 100128.

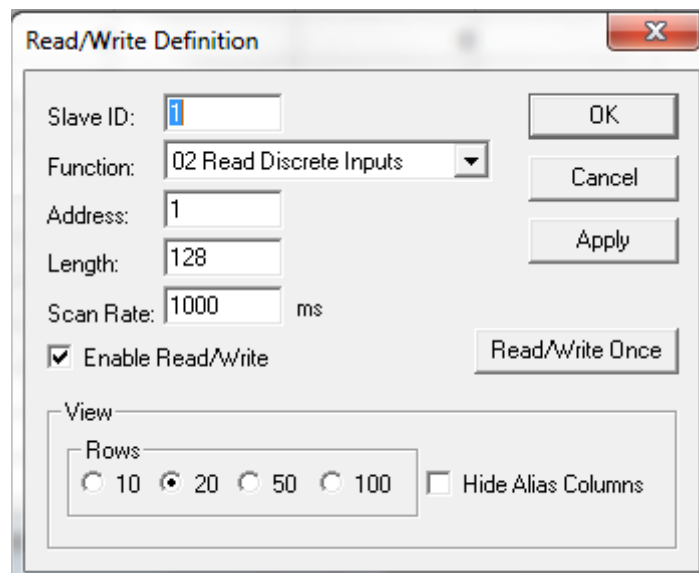

Troubleshooting with Modbus Poll, continued

1. From the Display menu, select PLC Address (Base 1).
2. From the Setup menu, select Read/Write Definition.
 - a. Slave ID = 1, change to match BX-MBIO module ID.
 - b. Function = 02 Read Discrete Inputs
 - c. Address = 1
 - d. Length = 128
 - e. Scan rate = 1000ms (user preference)
 - f. View rows = 20 (user preference)

For input registers related to the BX-04THM, BX-08AD-2B and BX-08AD-1 modules, use the Mbpoll3 window. Read from input registers 300001 to 300020.

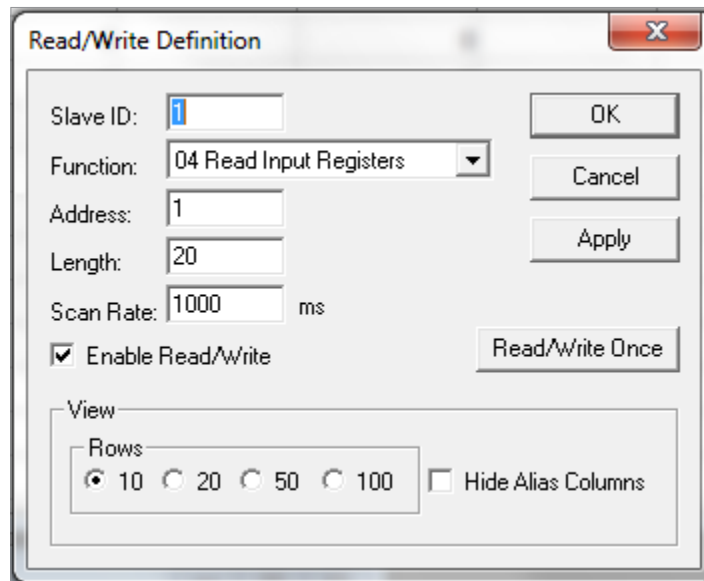

1. From the Display menu, select PLC Address (Base 1).
2. From the Setup menu, select Read/Write Definition.
 - a. Slave ID = 1, change to match BX-MBIO module ID.
 - b. Function = 04 Read Input Registers
 - c. Address = 1
 - d. Length = 20
 - e. Scan rate = 1000ms (user preference)
 - f. View rows = 10 (user preference)

Troubleshooting with Modbus Poll, continued

For holding registers related to the BX-08DA-2B and BX-08DA-1 modules, use the Mbpoll4 window. Read from holding registers 400001 to 400016.

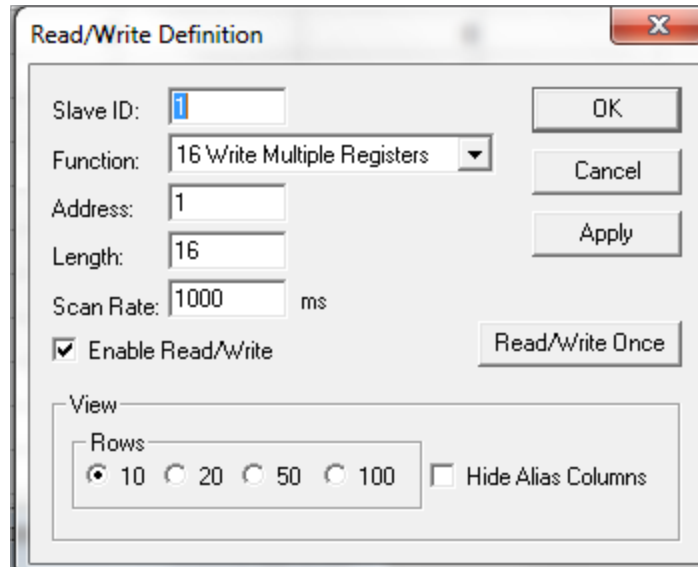

1. From the Display menu, select PLC Address (Base 1).
2. From the Setup menu, select Read/Write Definition.
 - a. Slave ID = 1, change to match BX-MBIO module ID.
 - b. Function = 16 Write Multiple Registers
 - c. Address = 1
 - d. Length = 16
 - e. Scan rate = 1000ms (user preference)
 - f. View rows = 10 (user preference)

Troubleshooting with Modbus Poll, continued

Once each addressing group is configured, the Modbus Poll screen should look as follows (user must re-size windows):

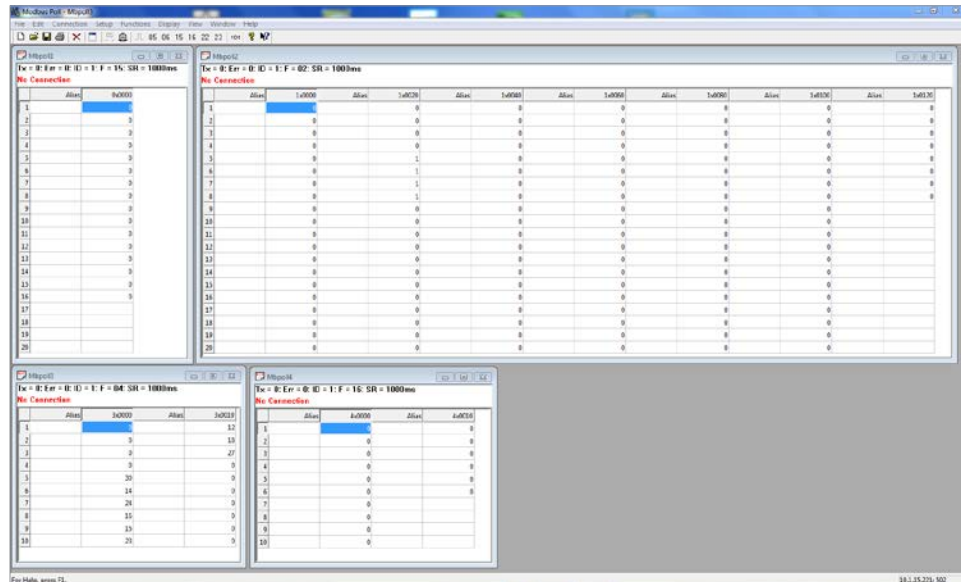

From the Connect menu, select Connect, to establish a connection with the BX-MBIO.

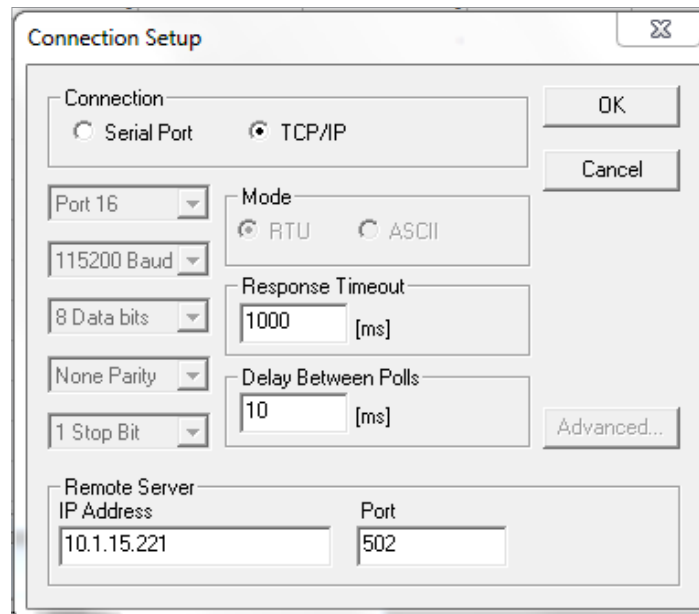

To setup the connection:

1. Connection = select TCP/IP.
2. Response timeout = 1000ms
3. Delay Between Polls = 10ms
4. IP Address = 10.1.15.221, the IP address of BX-MBIO
5. Port = 502

Troubleshooting with Modbus Poll, continued

Let's Get Some Values

Now that everything is wired, configured and mapped in Modbus Poll, we can write an output and see the corresponding input turn on. We will write an output from BX-08TR and that should turn on an input on the BX-08NA. We will then write a value to the analog output modules, BX-08DA-2B and BX-08DA-1 and we will see the input channel on the BX-08AD-2B and BX-08AD-1 display a value in the range of the output value.

Discrete I/O: BX-08TR to BX-08NA

- Coil 000009 turns on input 100001
- Coil 000010 turns on input 100002
- Coil 000011 turns on input 100003
- Coil 000012 turns on input 100004
- Coil 000013 turns on input 100005
- Coil 000014 turns on input 100006
- Coil 000015 turns on input 100007
- Coil 000016 turns on input 100008

Temperature input: BX-04THM wired to thermocouple

- Channel 1 data read to 300001
- Channel 2 data read to 300002
- Channel 3 data read to 300003
- Channel 4 data read to 300004

Analog I/O, voltage: BX-08DA-2B to BX-08AD-2B

- Output driven by 400001 wired to input value in 300005
- Output driven by 400002 wired to input value in 300006
- Output driven by 400003 wired to input value in 300007
- Output driven by 400004 wired to input value in 300008
- Output driven by 400005 wired to input value in 300009
- Output driven by 400006 wired to input value in 300010
- Output driven by 400007 wired to input value in 300011
- Output driven by 400008 wired to input value in 300012

Analog I/O, current: BX-08DA-1 to BX-08AD-1

- Output driven by 400009 wired to input value in 300013
- Output driven by 400010 wired to input value in 300014
- Output driven by 400011 wired to input value in 300015
- Output driven by 400012 wired to input value in 300016
- Output driven by 400013 wired to input value in 300017
- Output driven by 400014 wired to input value in 300018
- Output driven by 400015 wired to input value in 300019
- Output driven by 400016 wired to input value in 300020

Additional BX-EBC100 and BX-MBIO Modbus Mapping Information

Modbus Mapping for I/O

BX-EBC100 and BX-MBIO Discrete Input and Output Modbus Mapping				
Modbus Data Type (Bit)	Memory Type	Address Range Bit (Input/Hold Registers)	Words (Bytes/Bits)	Access
Coil	Discrete Output	000001 – 000512 (402001 – 402032)	32 (64/512)	R/W
Input	Discrete Inputs	100001 – 100512 (302001 – 302032) (411625 – 411656)*	32 (64/512)	R

BX-EBC100 and BX-MBIO Analog Input and Output Modbus Mapping				
Modbus Data Type (Word)	Memory Type	Address Range Input/Hold Registers	Words (Bytes)	Access
Input Register	Analog Input Register	300001 – 300128 (412251 – 412378)	128 (256)	R
Holding Register	Analog Output Register	400001 – 400128	128 (256)	R/W

System Memory Modbus Mapping

BX-EBC100 and BX-MBIO System Memory Modbus Mapping					
	Input Registers	Holding Registers	Words (Bytes)	Description	Access
Version Data	307001 307002 307003 307004 307005 307006	419251 419252 419253 419254 419255 419256	6 (12)	1 - OS Major Version 2 - OS Minor Version 3 - OS Build Version 4 - Booter Major Version 5 - Booter Minor Version 6 - Booter Build Version	R
MS Tick Data	307007 – 307008	419257 – 419258	2 (4)	Millisecond Tick Data Registers	R
Reserved*	307009 – 307010		2 (4)	Used by the System	
Device Data	307011 307012 307013 307014 307015 307016 – 307018 307019 307020 307021 307022 307023 307024 – 307027 307028 307029 307030 307031 307032 307033 307034 307035 307036 – 307041 307042 – 307100	419261 419262 419263 419264 419265 419266 – 419268 419269 419270 419271 419272 419273 419274 – 419277 419278 419279 419280 419281 419282 419283 419284 419285 419286 – 419291 419292 – 419350	90 (180)	1 - Version of Device 2 - Family 3 - Processor 4 - Module Type 5 - Status Code (6-8) - Ethernet Address 9 - RAM Size 10 - Flash Size 11 - Batt Switch 12 - DIP Settings 13 - Media Type (14-17) - Reserved* 18 - Model Number 19 - Ethernet Speed 20 - Reserved* 21 - IO -tal Byte Count 22 - Bit Input Byte Count 23 - Bit Output Byte Count 24 - Non-bit Input Byte Count 25 - Non-bit Output Byte Count (26-31) - IP Configuration (32-90) Reserved*	R
<i>Table continued on next page</i>					

Additional BX-EBC100 & BX-MBIO Modbus Mapping Info, continued

BX-EBC100 and BX-MBIO System Memory Modbus Mapping (continued)					
	Input Registers	Holding Registers	Words (Bytes)	Description	Access
Module IDs	307101 – 307109	419351 – 419359	9 (18)	I/O module ID numbers per slot location. Address 307102 (419352) is for the first expansion I/O module, Slot 1.	R
Module Information	307201 – 307204	419451 – 419454	36 (72)	(4 words per slot) Slot 0 words; Reserved*	R
	Slot 1 307205 307206 307207 307208	Slot 1 419455 419456 419457 419458		Slot 1 words: 1 - Bit Input Count 2 - Bit Output Count 3 - Non-bit Input Count 4 - Non-bit Output Count	
	307209 – 307236	419459 – 419486		Words for Slot 2 to Slot 8	
I/O Module Status	307401 – 307420	419651 – 419670	200 (400)	(20 words per slot) Slot 0 words; Reserved*	R
	Slot 1 307421	Slot 1 419671		Slot 1 words: 1 - Flags with bits indicating presence of an Error Bit 0: If set, indicates that Error Value is non-zero	
	307422 307423 – 307440	419672 419673 – 419690		2 - Error Code - refer to Error Codes Table. 3 - 20: Reserved*	
	307441 – 307580	419691 – 419830		Words for Slot 2 to Slot 8	
	307581 – 307600	419831 – 419850		Reserved*	
Reserved*		404001 – 408096	4096 (8192)	Used by system	
Dynamic Data		410001	20 (40)	Words per BX-EBC100 1 - Refer to Error Codes Table. Bits 0 to 11: Error code. Bit 12: Module error exists. May be triggered by: 1. Internal Error 2. Too much I/O to fit into the internal buffer Bits 13 to 15: Reserved for system use. Example of error E126: 410001 = 4222 = 107E (hex), Where 126 = 7E (hex), plus 4096 when bit 12 is on. 2-6 - Reserved*	R W
		410002 – 410006 410007		7 - Link Monitor Timeout (EBC communication watchdog timer) - 0 to disable; range 0 - 10000ms.	
		410008 – 410020		8-20 - Reserved*	
	Reserved*	410021 – 410276		256 (512)	
Reserved*		411125 – 411188	64 (128)	Used by system	
Reserved*		419259 – 419260	2 (4)	Used by system	
Reserved*		460001 – 460200	200 (400)	Used by system	

*Reserved - used by system. User should not write to these addresses.

Additional BX-EBC100 & BX-MBIO Modbus Mapping Info, continued

Error Codes

BX-EBC100 and BX-MBIO Error Codes		
Error Code	Description	Additional Information
E000	No Error	
E013	This is a buffer overflow condition	This error indicates an internal buffer overflow condition that should be reported.
E119	Data not valid.	This error indicates that more I/O was found in the system than the firmware can handle. Can also be an internal error that should be reported.
E126	Module is write protected.	This Error can show up if the module is actively being used by a Do-more! PLC. Also, this error may be the result of DIP switch 5 being on which write-protects the module. Several functions are not available while the module is being used from a Do-more! PLC.
E165	Module configuration is incorrect.	This Error indicates that the I/O configuration has changed from what has been stored for things such as analog config data. Moving configured analog modules around in the base will cause this error. The configuration will need to be re-written to fix this.

Notes: