

DirectLOGIC PLC Programming Cables

Pin labeling conforms to IBM DTE and DCE standards

D2-DSCBL \$14.00

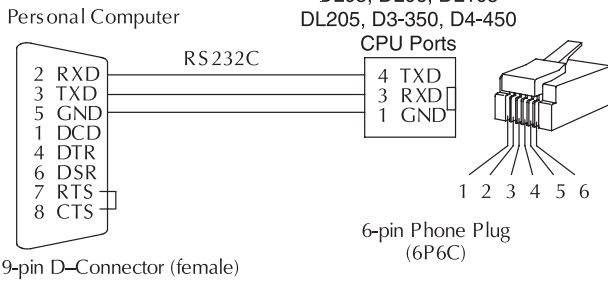

D2-DSCBL-1 \$30.00

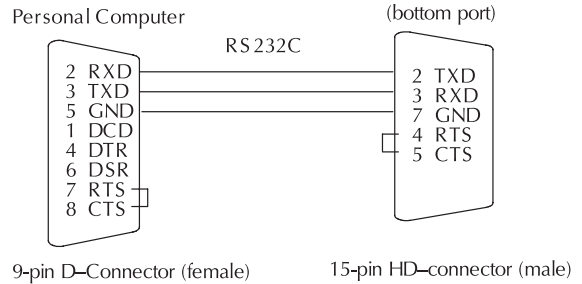

D3-DSCBL-1 \$30.00

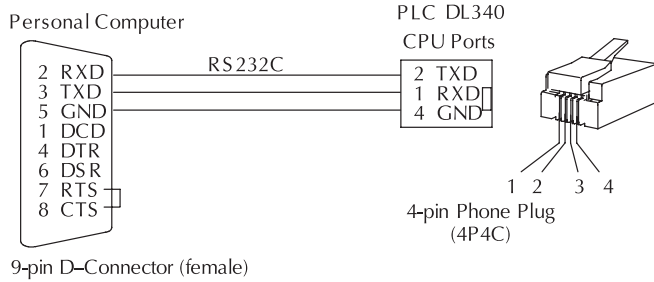

D3-DSCBL-2 \$30.00

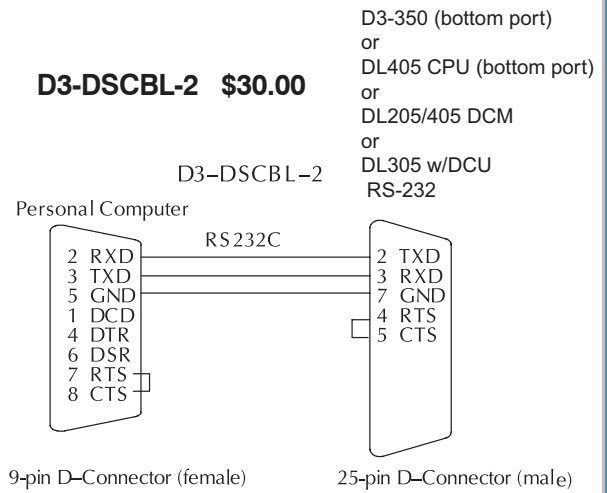

D4-DSCBL \$30.00

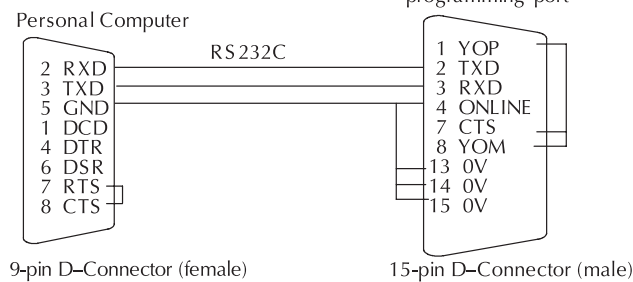

Straight-through Patch Cable (Ethernet)

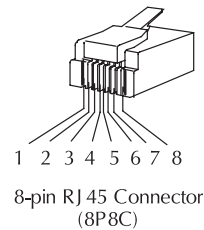
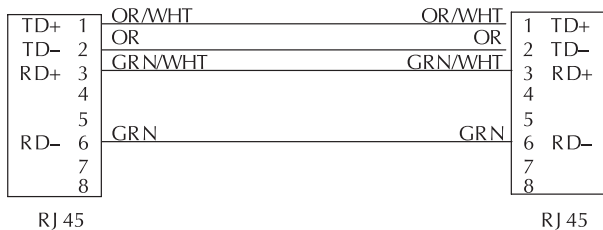

Crossover Cable (Ethernet)

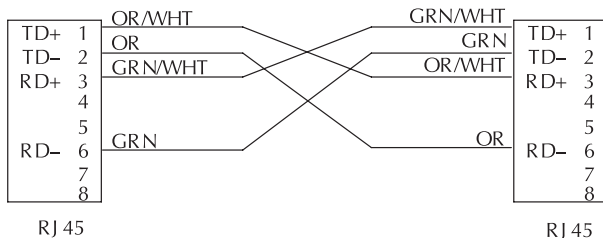

All Ethernet and ECOM patch cables should be Category 5, UTP Cable. The diagram illustrates the appropriate wire position in the RJ 45 connector.

Company Information

Control Systems Overview

CLICK PLC

Do-More PLCs Overview

Do-More H2 PLC

Do-More T1H PLC

DirectLOGIC PLCs Overview

DirectLOGIC DL05/06

DirectLOGIC DL105

DirectLOGIC DL205

DirectLOGIC DL305

DirectLOGIC DL405

Productivity Controller Overview

Productivity 3000

Universal Field I/O

Software

C-More HMI

C-More Micro HMI

ViewMarq Industrial Marquees

Other HMI

Communications

Appendix Book 1

Terms and Conditions