

Example: ZRH-4GATE-SET

Options

If a key exchange box should be used this can be achieved by upgrading the system with a 1001-KEYMODULE-SET. See separate datasheet.

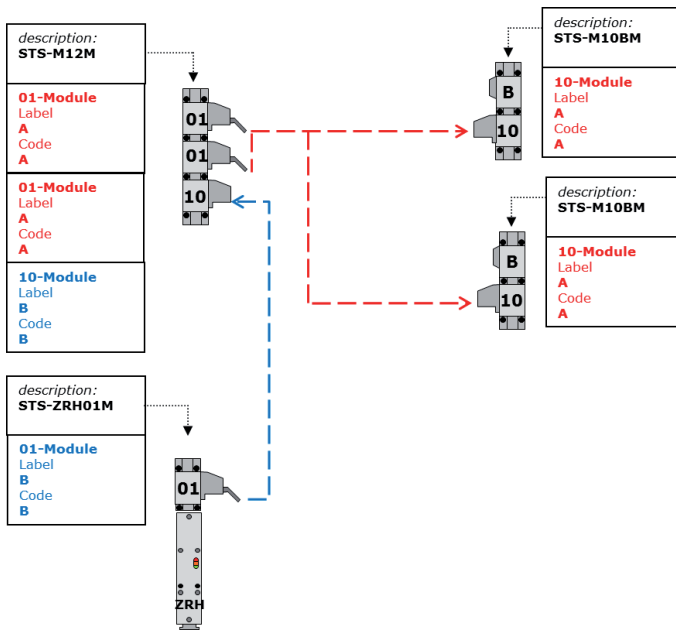

If a safety key for personal protection against being locked in is required a 01-SAFETY-KEY-SET can be added to the mechanical gatelock M10BM. See separate data sheet.

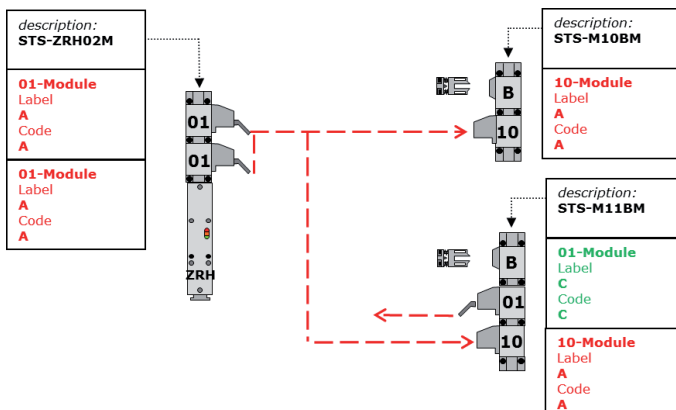

STS-System Benefits

- TÜV certificate according to the legal and standard requirements
- For safety applications up to PLE/Category 4 according to EN/ISO 13849-1
- Modular and expandable system
- Rugged stainless steel design
- Wireless mechanical safeguarding
- Combines the benefits of safety switch, solenoid locking and key transfer in a single system
- Easy installation through comprehensive accessories
- Protection against lock-in

Features ZRH-4GATE-SET

The unit is particularly suitable for applications with:

- Several secured entries
- Single-channel/ redundant/ diverse safety circuits
- Rugged ambient conditions

Approvals and marking



Application

To secure separating guards such as safety gates and hoods in machine and plant engineering.

Design and Operation

Attention!



Hazards must be ruled out before a key can be removed at any time and the movable part of the guard can then be opened!

The STS switch unit must be integrated into a system and connected with a control unit so that the hazardous machine can only run when the guard is locked and closed.

The machine can only be restarted after the key was returned to its original position. Key removal is queried by the contacts of key monitoring.

This gate securing system is suitable for 4 doors. It consists of 1 ZRH04M module and of 4 M10BM units. The ZRH04M module locks the keys in place, in order to operate the machine. Operating the solenoid to extract one key will immediately switch the magnet position contacts of the ZRH04M unit, stopping any dangerous movement. With the extracted key, the operator moves to one of the 4 gates. Inserting the key into the mechanical gatelock M10BM will open the gate. As long as the gate is open, the key cannot be extracted. After closing the gate the key can be returned to the ZRH04M unit and by inserting the last one of the keys the machine can be restarted.

Options

If the ZRH...M solenoid lock should be mounted directly on the gate, already securing the main entrance gate, a B-ACTUATOR-SET can be added allowing to secure 3 gates with an ZRH-2GATE-SET. see separate datasheet.

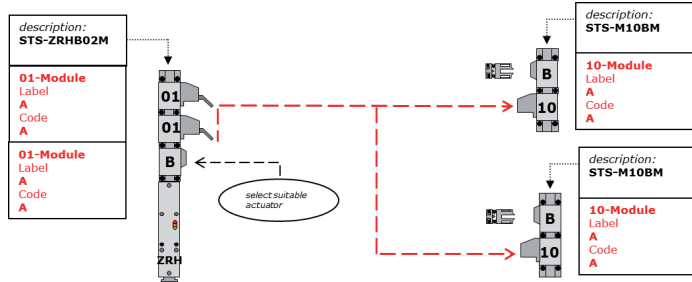

If more people need to enter the dangerous zone they can secure themselves using personal padlocks, when a PADLOCKMODULE-SET is added to the ZRH...M solenoid lock. See separate datasheet.

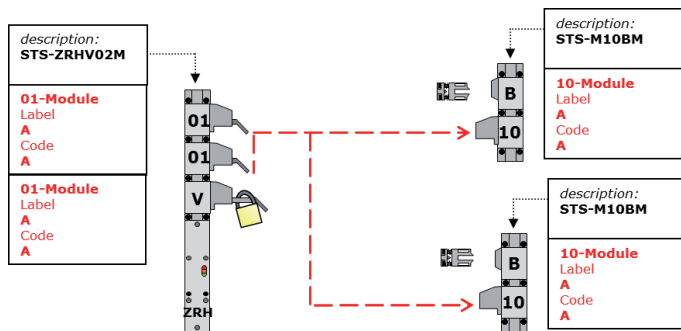

Circuit Diagrams

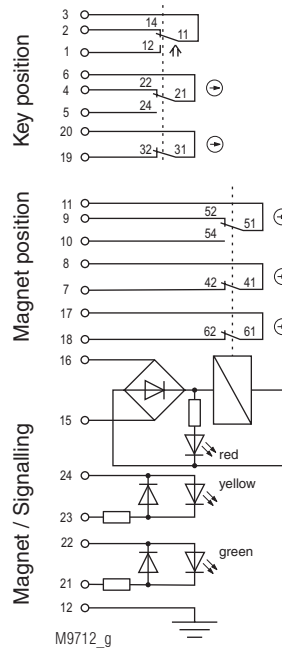

Fig. 1:
Solenoid locking activated:
Magnet locked,
Key inserted

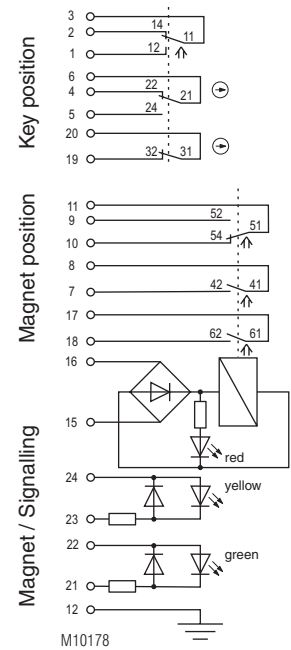

Fig. 2:
Solenoid locking deactivated:
Magnet released,
Key inserted

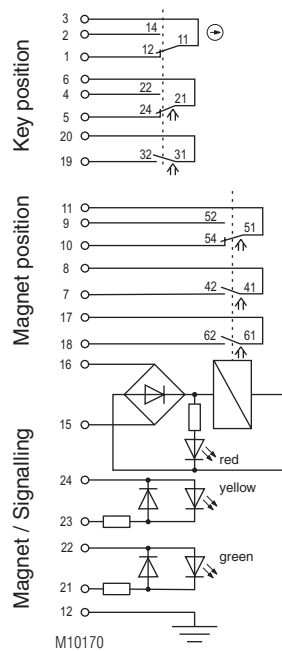

Fig. 3:
Solenoid locking deactivated:
Magnet released,
Key removed

Switching logic

		Door contacts		
		3	2	1
Door contacts	3			
	6			
	19			
	20			
Magnet contact	11			
	7			
	17			
Control signal Magnet	15			
	16			

■ closed
□ open

The state shown in **Figure 3** does not depend on the control signal of the magnet.

If the control signal is applied and the key inserted the solenoid locking changes to the state of **Figure 2**.
If no signal is applied and the key inserted the solenoid locking changes to the state of **Figure 1**

Technical Data

Enclosure:	Stainless steel V4A / AISI 316L
Degree of protection:	IP 65
Temperature range standby current principle:	- 25 °C to + 60 °C
Temperature range load current principle:	- 25 °C to + 40 °C
Storage temperature:	- 40 °C to + 80 °C
Mechanical principle:	Rotating axis with redundant actuation
Connection method:	Cage tension spring clamping
min. connection cross-section:	0.25 mm ²
max. connection cross-section:	1.5 mm ²
Cable entry:	1 x M20 x 1.5
B10 _d :	2 x 10 ⁶ switching cycles
Electrical service life:	5 x 10 ⁶ switching cycles
Locking force:	min. 1000 N Depending on actuator and actuator module
Shearing force:	min. 1000 N; depending on actuator
Solenoid locking principle:	Standby current, failure locking-proof
Magnetic principle:	Standby current or load current
min. operating speed:	100 mm/s
max. operating speed:	500 mm/s (by exception, 1500 mm/s is permitted)
max. switching frequency:	360/h
Operating mode:	100% ED
Nominal voltage U _N :	AC/DC 24 V
Nominal voltage range:	0.85 ... 1.1 U _N
Power consumption:	6 W
Rated impulse voltage:	0.8 kV
Rated insulation voltage:	< 60 V
Contacts	
Door position:	1 NC contact, 2 diverse changeover contacts
Magnet position:	2 NC contacts + 1 changeover contact
Switching principle:	Changeover contact with forced-opening snap-action switches
Max. operating current	
Standby current principle:	2 A
Load current principle:	1 A
Contact material:	Ag / AgSnO ₂
Short circuit strength, max. fusing:	4 A gG
Indicator	LED red: Magnet energized LED yellow/green (separate selection possible)
Test principles:	EN ISO 13849-1:2008 EN 1088+A2:2008 EN 60947-5-1:2005 GS-ET 19:04.2004
Intended use:	up to max. cat. 4, PL e according to EN ISO 13849-1
Mounting:	according to DIN EN 50041
Contact elements:	IEC EN 60947-5-1 Appendix K
Diagnostic coverage (DC), (mechanical):	
Logic and output	cat. 2 cat. 3 cat. 4
STS-ZRH01M	97 % 99 % 99 %
Fault exclusions:	none
Protection against faults of common cause:	see table in STS design guide
Repair and replacement:	by manufacturer only
Test intervals:	semi-annually recommended min. once a year

Available sets:

ZRH-1GATE-SET
ZRH-2GATE-SET
ZRH-3GATE-SET
ZRH-4GATE-SET
ZRH-5GATE-SET

Actuators to be ordered separately 1 for each B-module:

S-ACTUATOR
C-ACTUATOR
CS-ACTUATOR

Accessories:

1001-KEYMODULE-SET
01-SAFETY-KEY-SET
B-ACTUATOR-SET
PADLOCKMODULE-SET

