

Technical Support

For complete product documentation, video training, and technical support, go to www.flowline.com.

For phone support, call 562-598-3015 from 8am to 5pm PST, Mon - Fri. (Please make sure you have the Part and Serial number available.)

Flowline Inc. 10500 Humbolt St, Los Alamitos, CA 90720

FLOWLINE®

Warranty

Flowline warrants to the original purchaser of its products that such products will be free from defects in material and workmanship under normal use and service in accordance with instructions furnished by Flowline for a period, which is equal to the shorter of one year from the date of purchase of such products or two years from the date of manufacture of such products. Flowline's obligation under this warranty is solely and exclusively limited to the repair or replacement, at Flowline's option, of the products or components, which Flowline's examination determines to its satisfaction to be defective in material or workmanship within the warranty period. Flowline must be notified pursuant to the instructions below of any claim under this warranty within thirty (30) days of any claimed lack of conformity of the product. Any product repaired or replaced under this warranty will be warranted only for the remainder of the original warranty period.

Returns

Products cannot be returned to Flowline without Flowline's prior authorization. To return a product that is thought to be defective, go to www.flowline.com, and submit a customer return (MRA) request form and follow the instructions therein. All warranty and non-warranty product returns to Flowline must be shipped prepaid and insured. Flowline will not be responsible for any products lost or damaged in shipment.

Limitations

This warranty does not apply to products which: 1) are beyond the warranty period or are products for which the original purchaser does not follow the warranty procedures outlined above; 2) have been subjected to electrical, mechanical or chemical damage due to improper, accidental or negligent use; 3) have been modified or altered; 4) anyone other than service personnel authorized by Flowline have attempted to repair; 5) have been involved in accidents or natural disasters; or 6) are damaged during return shipment to Flowline. Flowline reserves the right to unilaterally waive this warranty and dispose of any product returned to Flowline where: 1) there is evidence of a potentially hazardous material present with the product; or 2) the product has remained unclaimed at Flowline for more than 30 days after Flowline has dutifully requested disposition. This warranty contains the sole express warranty made by Flowline in connection with its products. ALL IMPLIED WARRANTIES, INCLUDING WITHOUT LIMITATION, THE WARRANTIES OF MERCHANTABILITY AND FITNESS FOR A PARTICULAR PURPOSE, ARE EXPRESSLY DISCLAIMED. The remedies of repair or replacement as stated above are the exclusive remedies for the breach of this warranty. IN NO EVENT SHALL FLOWLINE BE LIABLE FOR ANY INCIDENTAL OR CONSEQUENTIAL DAMAGES OF ANY KIND INCLUDING PERSONAL OR REAL PROPERTY OR FOR INJURY TO ANY PERSON. THIS WARRANTY CONSTITUTES THE FINAL, COMPLETE AND EXCLUSIVE STATEMENT OF WARRANTY TERMS AND NO PERSON IS AUTHORIZED TO MAKE ANY OTHER WARRANTIES OR REPRESENTATIONS ON BEHALF OF FLOWLINE. This warranty will be interpreted pursuant to the laws of the State of California. If any portion of this warranty is held to be invalid or unenforceable for any reason, such finding will not invalidate any other provision of this warranty.



Model: LU27 (-0, -1)

EchoSonic® II

NEMA 6 Enclosure

Quick Start



QS300115 Rev.B
©2010 Flowline, Inc.
All Rights Reserved
Made in USA

FLOWLINE We do Your Level Best

10500 Humbolt Street, Los Alamitos, CA 90720 USA
Tel: 562.598.3015 Fax: 562.431.8507 www.flowline.com

Welcome to the EchoSonic® II Quick Start

The EchoSonic® II Quick Start is meant to show some of the more common setup solutions to getting the sensor up and running quickly. If you run into an issue that is not addressed here or wish to install or set up with a non-standard configuration, please address the EchoSonic® II Manual or refer to the Flowline website at www.flowline.com.

We Do Your Level Best

Thank you for purchasing the EchoSonic® II. This general purpose ultrasonic sensor provides non-contact detection powered by the 4-20 mA loop. This Quick Start includes everything you'll need to get the sensor up and running. For complete information, please refer to EchoSonic® II documentation located at www.flowline.com.

Components

Depending on how the sensor was shipped to you, you may or may not have the components shown below. All three components, including the sensor, USB Fob, and Viton® gasket are required to configure and install the sensor. If you need any additional components, you can order them directly from Flowline.

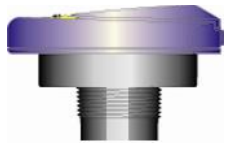

EchoSonic® II
LU27-0 (with cable)
LU27-1 (with cable)



USB Fob
L199-1001
(USB Fob not
provided with
LU2X-00 version)



Viton® gasket
200128 (1")

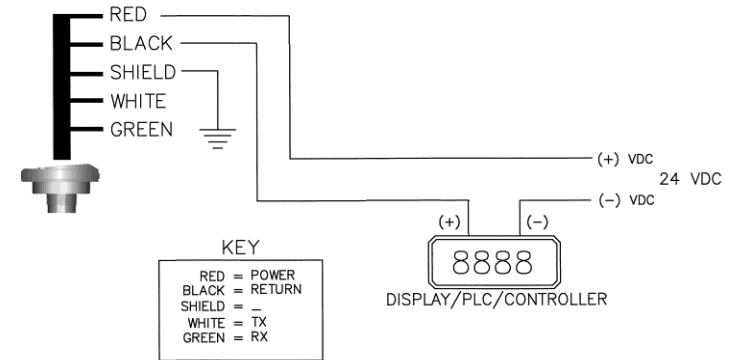

Typical Wiring diagram
Your WebCal Wiring Diagram may vary.

General notes for electrical connections, usage and safety:

- Where personal safety or significant property damage can occur due to a spill, the installation must have a redundant backup safety system installed
- Wiring should always be completed by a licensed electrician
- Supply voltage should never exceed 28 VDC
- Protect the sensor from excessive electrical spikes by isolating the power whenever possible
- The sensor materials must be chemically compatible with the liquids to be measured
- Design a fail-safe system for possible sensor and/or power failure
- Never use the sensor in environments classified as **Hazardous**

Wiring the Sensor

After mounting the sensor, make the necessary electrical connections. A wiring diagram with specific recommendations for the sensor's configuration can be printed from the WebCal program. A general wiring diagram is shown on the previous page.

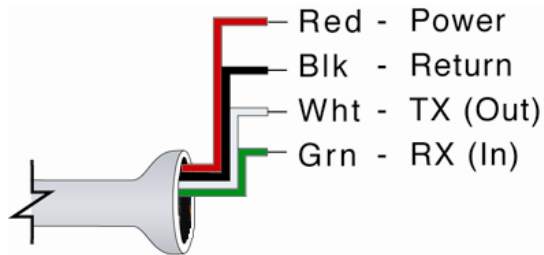

Red and **Black** leads are for connection to a 24 VDC power supply or to a 4-20 mA loop power source. The red and black wires can be extended more than 1000 feet using 22 gauge or larger wire, however do not extend the green and white wires.

White and **Green** leads are reserved for use with WebCal and should not be connected during usage in the application. These wires should not be connected to WebCal while power is supplied from any source other than the LI99 FOB.

Shield. This common wire provides transmission protection.

Never allow the white or green wires to touch any power supply.

Configuring the Sensor

Configuration of your sensor should be performed prior to mounting, since it requires connection to your PC.

Step 1: Install the WebCal Software

Download WebCal from www.flowline.com onto a PC with the following minimum specifications:

Windows® 2000/XP/Vista/7, 10 MB storage space, 256 MB RAM, 1 USB 2.0 port

Double-click the WebCal icon to install before proceeding to Step 2. You must have an active Internet connection to install WebCal, as it will automatically verify driver updates.

Step 2: Connect the USB Fob

NOTE: Do not connect the Fob until after you've installed WebCal.

The sensor communicates to its configuration software through the USB Fob. Prior to connecting the Fob, ensure that all external power is disconnected from the sensor as power is provided through the PC's USB 2.0 port. Do not use a cable connecting the sensor to the Fob any longer than 15 feet.

- 1) Connect the red, green, white, and black wires from the sensor to the corresponding colored terminals on the Fob (as shown in the diagram).
- 2) Tighten the terminal screws with a slotted screwdriver.
- 3) Plug the Fob into your PC's USB port.

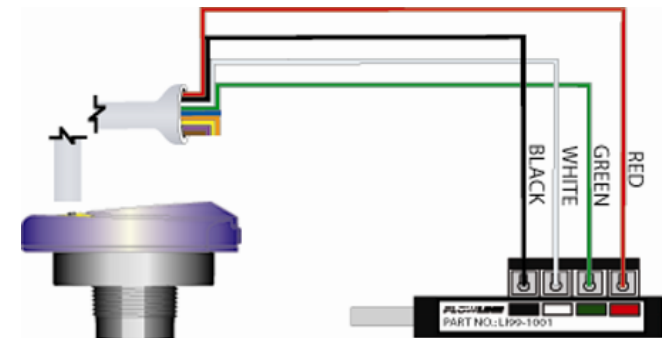

Step 3: Configure through WebCal

These instructions will walk you through configuration of the sensor through WebCal. For more information, click the WebCal **HELP** button in the lower right corner or anywhere on the WebCal screen or refer to the sensor Manual found at www.flowline.com.

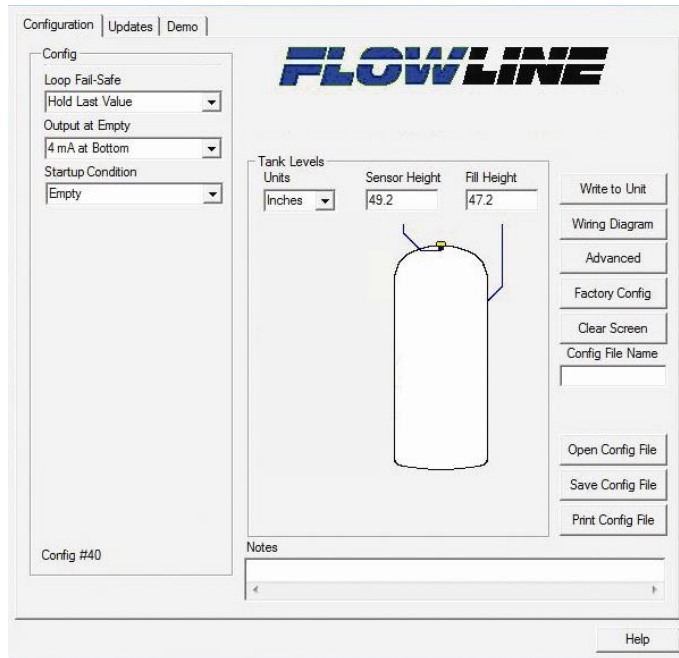

WebCal Configuration Screen

Using a Standpipe

A standpipe may be used to dampen turbulence, separate surface foam from the point of measurement or increase performance in heavy vapor. Select a 3" pipe (a 2" pipe is usable, but the minimum) and attach the sensor with a coupling and reducer bushing. The pipe length should run the measurement span and the bottom of the pipe should remain submerged at all times to prevent foam from entering the pipe. Cut the bottom end of the pipe at 45° and drill a 1/4" pressure equalization hole high in the dead band. The pumps should not drive liquid past the open end of the standpipe which causes the liquid in the pipe to become turbulent.

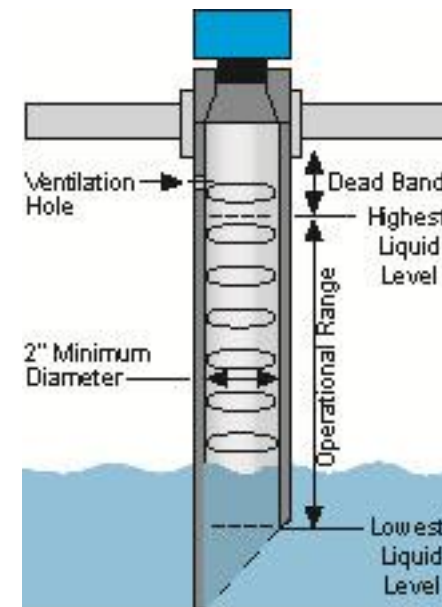

Mounting with a Standpipe

Mounting the Sensor

The sensor should always be mounted perpendicular to the liquid surface using the provided Viton® mounting gasket. Insure that there are no restrictions or obstacles in the path of the ultrasonic signal. Always use fittings with thin wall mounting structures that isolate the transducer. This will provide the best performance over the lifetime of the product. Further mounting information can be found on the Flowline website at www.flowline.com. An instructional video on is also available on the website.

The LU27 has a 1" NPT or G fitting and requires more care in mounting to reduce any coupling of the ultrasonic signal to the mounting structure. The following fittings are recommended:

For installations in existing 2" fittings:

- 1) Use LM52-1400 2" Thread x 1" Thread adapter. (An Adapter with an air gap around the 1 inch threads as shown is recommended)



For installations in plastic tanks:

- 1) Use a Bulkhead fitting LM52-1890 1" inch Bulkhead fitting,
- 2) Use a Bulkhead fitting LM52-2890 in combination with LM52-1400 or,
- 3) Weld a plastic 1" half coupler to the tank's top.



For installations in metal tanks:

- 1) Use the recommended bulkhead fittings as shown above or a LM52-1850 1" Flange. The flange fitting must have a riser for the threaded section. Do not drill or tape a blind flange.
- 2) While installations directly into a 1" metal fitting are not recommended, acceptable results may be obtained if the 1" fitting is a half coupling in form and the outer diameter of the coupler is tightly wrapped in vinyl tape to dampen vibrations.



For installations in open tanks and sumps:

- 1) Use Flowline's LM50-1001-1 side mount bracket, which includes a 2" x 1" thread reducer bushing.



Using the drop-down menus on the left of the WebCal screen, set the configuration for your application requirements. When a selection does not apply to your application, "Not Applicable" will appear in the drop-down. Make sure all drop-downs are set appropriately for your application before moving to the Tank Level section.

- **Loop Fail Safe.** Use this setting to choose the output level should the sensor not receive an echo.
- **Output at Empty.** Use this setting to change the 4-20 mA setting from its default.
- **Startup Condition.** During the 15-20 seconds during which the sensor starts up, this describes the level at which it will begin searching for the contents of the tank.

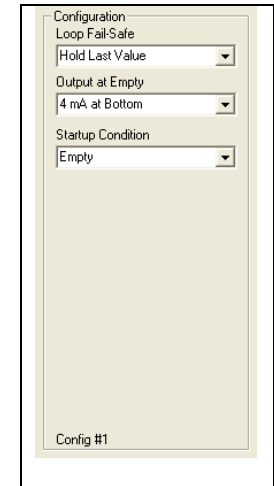

NOTE: If you would like to start over, click the **Clear Screen** button on the right.

Configuration Settings

Enter the appropriate tank level set points for your application.

- **Units.** Display measurements in inches or centimeters.
- **Sensor Height.** Distance measured from the bottom of the empty tank to the bottom of the transducer. Under factory configuration, this becomes the 4 mA set point.
- **Fill Height.** Distance measured from the bottom of the empty tank to the maximum fill height within the tank. Under factory configuration, this becomes the 20 mA set point.

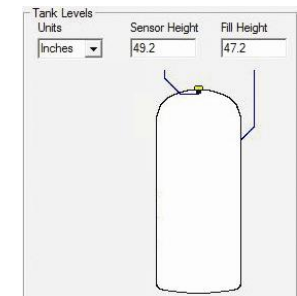

Tank Level Settings

The options on the right of the WebCal screen to finalize the configuration.

- **Write to Unit.** Send your configuration into sensor.
- **Wiring Diagram.** Open PDF wiring schematic of your configuration.
- **Advanced.** Configure advanced settings. Read the section below on advanced setting options
- **Factory Config.** Return sensor to the original factory configuration.
- **Clear Screen.** Clears the screen of configuration settings.
- **Config file.** Name, save, open or print your configuration for later use.

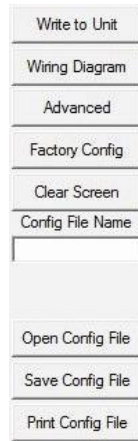

Finalize Settings

The **Advanced** button is used for options available when setting up the sensor with special, non-standard features. Many of these features are available for specific applications that may change from time to time. Consult WebCal's **HELP** file for the latest information on the use of any of these features.

The more commonly used Advanced features are the Invert Relay and Increase Output Filtering described below.

- **Increase Output Filtering.** Select this radio button to add additional filtering to the 4-20 mA output.
- **Decrease Output Filtering.** Select this radio button to remove all output filtering on the 4-20 mA output.

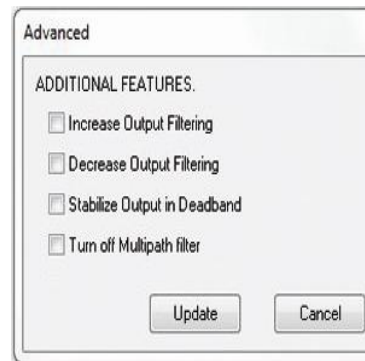

Advanced Settings

Before configuration can be completed:

You must click the **Write to Unit** button to save the settings to the unit.

Then, click **Wiring Diagram** for a hard copy of the sensor settings.

Finally, enter the file name under which you wish to save the configuration file and click **Save Config File**.

Configuration is now complete.

For Updates to WebCal, or to make sure you're using the most up-to-date version available, click the **Update** tab on the top of the WebCal screen.

To view the Demo page (shown here), click the **Demo** tab on the top of the WebCal screen.

The demo page is a simulation, useful for verifying the configuration. There is not enough power going to the unit to power the relays. The larger numbers represent the liquid level while the smaller numbers show the distance from the transducer to the surface. The sensor must be pointed at a flat perpendicular surface.

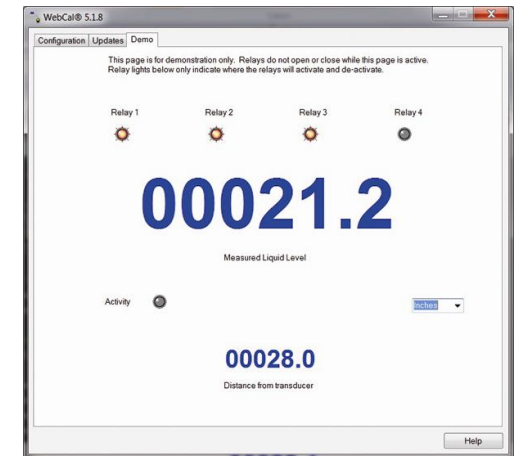

Demo screen (Simulation)

Disconnect the USB Fob before the next step: Mounting the sensor